



2022-2023

NON-ROTATING METALCUTTING TOOLS



Contents

<h2>Turning</h2>		<ul style="list-style-type: none"> Contents A2 Toolholders A47 Inserts A263 	<h1>A</h1>	<p>Turning</p>
<h2>Parting & Grooving</h2>		<ul style="list-style-type: none"> Contents B2 Toolholders B29 Inserts and Solid Bars B109 	<h1>B</h1>	<p>Parting & Grooving</p>
<h2>Thread Making</h2>		<ul style="list-style-type: none"> Contents C2 Thread Turning C9 	<h1>C</h1>	<p>Thread Making</p>
<h2>Holemaking</h2>		<ul style="list-style-type: none"> Contents D2 Drilling Tools D15 Reaming Tools D225 	<h1>D</h1>	<p>Holemaking</p>
<h2>Materials & Grades</h2>		<ul style="list-style-type: none"> Grade Comparison Table I2 Chip Braker Comparison Table I10 Hardness Conversion Table I14 Material Conversion Table I16 	<h1>I</h1>	<p>Materials & Grades</p>
<h2>Index</h2>				<p>Index</p>

How to use the catalogue page



« Main Contents

Select an application line from the main Table of Contents. Each line is color coded in alphabetical order.



Tool Selection Guide »

Choose the required machining solutions and tools from tool selection guide.

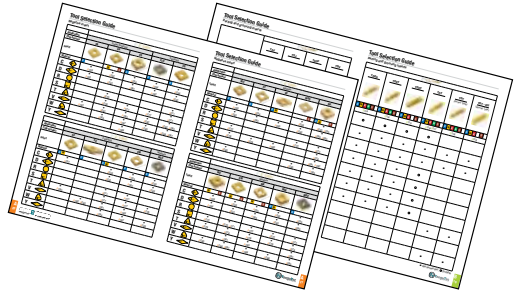

Products Page »

Obtain detailed information of products such as dimensions, grades and related parts etc. Holder and insert pages are organized separately.

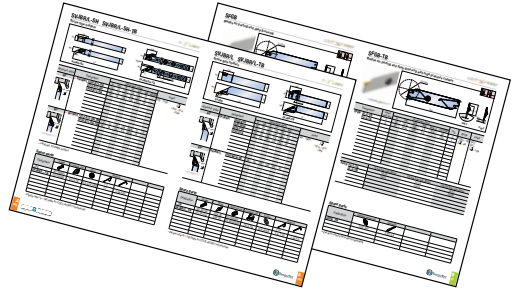

Alphabetical Index »

All tools are listed in the alphabetical index at the end of the catalogue.



Should you require more information and data from TaeguTec, please contact the nearest TaeguTec Global Service Center or visit our website. www.taegutec.com

TURNING



TURNING



contents

Tool Selection Guide

External Holders	A4
Internal Boring Bars	A16
Negative Inserts	A22
Positive Inserts	A26
Grades	A28
Chip Breakers	A33
External Toolholders	
Designation System for External Toolholders	A48
External Toolholders	A51
TURN-SFEED Holders	A94
POS-S-TURN Holders	A141
TOP-RAIL Holders	A163
COOL-BURST Accessories	A164
FLEX-TURN Holders	A166
C-ADAPTER	A174
Boring Bars	
Designation System for Boring Bars	A195
Boring Bars	A196
HUSH-BORE	A251

Guide to Icons



➤ Toolholder Page



➤ Insert Page



Inserts

Designation System	A264
Negative Inserts	A266
POS-S-TURN Inserts	A306
Positive Inserts	A308
TURN-SFEED Inserts	A319
Pipe Skiving Inserts	A336
TOP-RAIL Inserts	A338
Ceramic Inserts	A341
CBN/PCD Inserts	A353
Recommended Cutting Conditions	A366

Tool Selection Guide

External holders

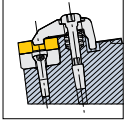

T-Holder







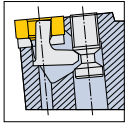

















 	 TCBNR/L A120	 TCKNR/L A120	 TCLNR/L A121 TCLNR/L-TB A122	 TXJNR/L A138 TXJNR/L-TB A139	 TXQNR/L A140
	 TDJNR/L A123	 TDJNR/L-TB A124	 TDNNR/L A125	 TDQNR/L A126	 TDUNR/L A126
	 TTFNR/L A130	 TTGNR/L A130	 TTJNR/L A130	 TTQNR/L(-TB) A131	
	 TSDNN A128	 TSKNR/L A129	 TSSNR/L A129		
 	 TVJNR/L A132	 TVJNR/L-TB A133	 TVQNR/L A134	 TVVNN A135	
 	 TZQNR/L A141	 TZQNR/L-TB A141	 TZXNN A142	 TZXNN-TB A142	
	 TWLNR/L A136	 TWLNR/L-TB A137			 THSNR/L A127

Tool Selection Guide

External holders



P Lever lock

	 PCBNR/L A69	 PCKNR/L A70	 PCLNR/L A71	 PCLNR/L-TB A71
	 PDJNR/L A72	 PDJNR/L-TB A72	 PDNNR/L A73	
	 PTFNR/L A79	 PTGNR/L A80	 PTTNR/L A80	
	 PSBNR/L A77	 PSDNN A77	 PSKNR/L A78	 PSSNR/L A78
	 PWLNR/L-TB A81			
	 PRDCN A74	 PRGCR/L A75	 PRGNR/L A76	

Tool Selection Guide

External holders

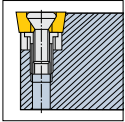

S Screw clamp







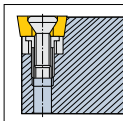





















80°				
	SCACR/L-SH A82	SCACR/L-SH-TB A82	SCLCR/L-SH A83	SCLCR/L-SH-TB A83
80°				
	SCLCR/L A84	SCLNR/L-RS A85 (0703)	SCLNR/L A85 (0703)	SCLNR-RS (-TB) A86 (0904)
55°				
	SDJCR/L-SH A87	SDJCR/L-SH-TB A87	SDJCR/L A88	SDJNR/L-RS A89
55°				
	SDJNR/L A89	SDJNR-RS A90 (1305)	SDJNR-RS-TB A90 (1305)	SDNCN-SH A91
55°				
	SDNCN-SH-TB A91	SDNCN A92	SDQNR/L A93	
60°				
	STFGR/L A98	STGCR/L-SH A99	STGCR/L-SH-TB A99	STGCR/L A100
60°				
	STGNR-RS A101 (1304)			

Tool Selection Guide

External holders



S Screw clamp

				
	SVJBR/L-SH A102	SVJBR/L-SH-TB A102	SVJBR/L A103	SVJBR/L-TB A103
				
	SVJCR/L-SH A104	SVJCR/L-SH-TB A104	SVJCR/L A105	SVJNR-RS A106
				
SVJNR-RS-TB A106	SVJNR/L A107	SVPBR/L A108	SVVBN-SH A109	
				
SVVBN-SH-TB A109	SVVBN A110	SVVCN A110		
				
SSDCN A97	SSSCR/L A97			
				
SRDCN A95	SRGCR/L A96	SRGCR/L-TB A96		
				
SFXCN A94			SWLNR/L-RS A111	SWLNR/L A111

Tool Selection Guide

External holders

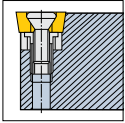

TM... Miniature tool holder (Screw clamp)

TMB Back turning holders			TMB-SVXCR A112 TMB-SVXCR-TB A112
			TMS-SCLCL A113
TMS Sleeve holders			TMS-SDUCL A114 TMS-SDUCR/L-TB A114 TMS-SDUNL A115 TMS-SDUNL-TB A115
			TMS-SVUBL A116 TMS-SVUBR/L-TB A116
TMY Y-axis holders			TMY-SDJCR A117 TMY-SDJCR-TB A117
			TMY-SVJBR A118 TMY-SVJBR-TB A118
TMZ Shift holders			TMZ-SDJCR A119
			TMZ-SVLBR A119

Tool Selection Guide

External holders

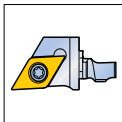

QE Modular head (Screw clamp)







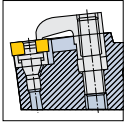





QE1 External turning modular head					
		QE1 SDJCR A166	QE1 SDJCR-TB A166	QE1 SDJNR A167	QE1 SDJNR-TB A167
		QE1 SVJBR A168	QE1 SVJBR-TB A168	QE1 SVJCR A169	QE1 SVJCR-TB A169
QE1B Back turning modular head					
		QE1B SVXCR A170	QE1B SVXCR-TB A170		
QE1Y Y-axis modular head					
		QE1Y SDJCR A171	QE1Y SDJCR-TB A171		

Tool Selection Guide

External holders



M Multi lock







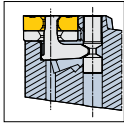

















	<div style="display: flex; justify-content: space-around; align-items: center;"> <div style="text-align: center;">  MDJNR/L A63 </div> <div style="text-align: center;">  MDNNN A63 </div> <div style="text-align: center;">  MDQNR/L A64 </div> </div>
	<div style="text-align: center;">  MTJNR/L A65 </div>
	<div style="display: flex; justify-content: space-around; align-items: center;"> <div style="text-align: center;">  MVJNR/L A66 </div> <div style="text-align: center;">  MVQNR/L A66 </div> <div style="text-align: center;">  MNVNN A67 </div> </div>
	<div style="text-align: center;">  MWLNR/L A68 </div>

Tool Selection Guide

External holders



H Hook lever holder







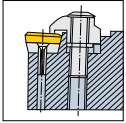





	 HCLNR/L-RS A55	 HCLNR/L A55		
	 HDJNR/L A56	 HDNRR/L A56	 HDQNR/L A57	 HDUNR/L A57
	 HTFNR/L A59	 HTGNR/L A59		
	 HSBNR/L A58	 HSDNN A58		
	 HVJNR/L A60	 HVQNR/L A60	 HVVNN A61	
	 HVJNR/L A60	 HVQNR/L A60	 HVVNN A61	
	 HwLNR/L A62			

Tool Selection Guide

External holders





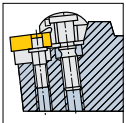

C Top clamp

	 <p>CTCPN A53</p>	 <p>CTFPR/L A53</p>	 <p>CTGPR/L A54</p>
	 <p>CSDPN A52</p>		
	 <p>CKJNR/L A51</p>	 <p>CKNNR/L A51</p>	
	 <p>CRDCN-120 A145 CRDCN-140 A145</p>	 <p>CRDCN-T A146 CRDCR-T A146</p>	 <p>CRGCR/L-120 A147 CRGCR/L-140 A147</p>



W Wedge clamp







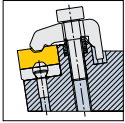

	 <p>WTENN A143</p>	 <p>WTGNR/L A143</p>	 <p>WTJNR/L A144</p>	 <p>WTQNR/L A144</p>

Tool Selection Guide

External holders





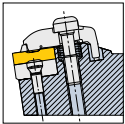

T-CH CH dimple holder

	 TCBNR/L-CH A149	 TCKNR/L-CH A149	 TCLNR/L-CH A150
	 TDJNR/L-CH A151	 TDNNN-CH A151	
	 TSSNR/L-CH A152		



T-DA DA dimple holder







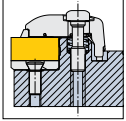









	 TCLNR-DA A153		
	 TSDNN-DA A154	 TSKNR-DA A154	

Tool Selection Guide

External holders



T-F Flat T-Holder







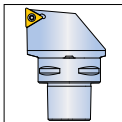





















	<div style="display: flex; justify-content: space-around; align-items: center;"> <div style="text-align: center;">  TCLNR/L-F A155 </div> <div style="text-align: center;">  CCLNR/L-F A148 </div> </div>
	<div style="text-align: center;">  TDJNR/L-F A156 </div>
	<div style="display: flex; justify-content: space-around; align-items: center;"> <div style="text-align: center;">  TSDNN-F A159 </div> <div style="text-align: center;">  TSKNR/L-F A159 </div> <div style="text-align: center;">  TSRNR/L-F A160 </div> <div style="text-align: center;">  TSSNR/L-F A160 </div> </div>
	<div style="text-align: center;">  TTJNR/L-F A161 </div>
	<div style="display: flex; justify-content: space-around; align-items: center;"> <div style="text-align: center;">  TRDNN-F A158 </div> <div style="text-align: center;">  TRGNR/L-F A158 </div> </div>
	<div style="text-align: center;">  TEGnr/L-F A157 </div>

Tool Selection Guide

External holders



C C-Adapter

	 C...HCLNR/L A176	 C...TCLNR/L A178	 C...SCLCR/L A183
	 C...HDJNR/L A176	 C...TDJNR/L A178	 C...SDJCR/L A183
	 C...HTGNR/L A177  C...HTJNR/L A177	 C...TTGNR/L A180  C...TTJNR/L A180	 C...STGCR/L A184  C...STJCR/L A184
	 C...HSSNR/L A177	 C...TSDNN A179	 C...TSSNR/L A179
	 C...TVJNR/L A180	 C...SVJBR/L A185	 C...SVVBN A185
	 C...TZQNR/L-TB A182		 C...TWLNR/L A181
	 C...SRDCN A184		

Tool Selection Guide

Internal boring bars

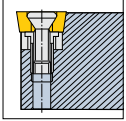

S Screw clamp







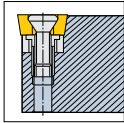



	S-SCLCR/L A212 C-SCLCR/L A213	S-SCLNR/L A214 A-SCLNR/L A214	S-SCLPR/L A215 A-SCLPR/L A215	E-SCLPR/L A216
	A-SDLNR/L A216	S-SDQCR/L A217	A-SDQNR/L A217	S-SDUCR/L A218
A-SDUNR/L A218	S-SDZCR/L A219			
	S-STFCR/L A221 C-STFCR/L A221	S-STFNR/L A222 A-STFNR/L A222	S-STFPR/L A223 A-STFPR/L A223	C-STFPR/L A224 E-STFPR/L A224
	S-STUBR/L A225 C-STUBR/L A225	S-STUNR/L A226 A-STUNR/L A226	C-STZBR/L A227	
	S-SVJBR/L A228 S-SVJCR/L A228	S-SVJPR/L A229	A-SVLNR/L A229	S-SVPBR/L A230 S-SVPCR/L A230
	A-SVPCR/L A230	S-SVQBR/L A232 S-SVQCR/L A232	S-SVUBR/L A233 S-SVUCR/L A233	
	A-SVPCR/L A230	S-SVQBR/L A232 S-SVQCR/L A232	S-SVUBR/L A233 S-SVUCR/L A233	

Tool Selection Guide

Internal boring bars







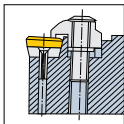

S Screw clamp

	 <p>S-SSKCR/L A220</p>		 <p>A-SXQNR/L A236</p>	 <p>A-SXUNR/L A236</p>
	 <p>A-SVLNR/L A229</p>	 <p>A-SVPCR/L A231</p>		
	 <p>S-SWLNRL A234</p> <p>A-SWLNRL A234</p>	 <p>S-SWUBRL A235</p> <p>C-SWUBRL A235</p>		



C Top clamp







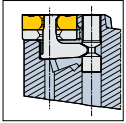





	 <p>S-CSKPR/L A197</p>
	 <p>S-CTFCR/L A198</p> <p>S-CTFPR/L A198</p>
	 <p>S-CKUNR/L A196</p>

Tool Selection Guide

Internal boring bars



H Hook lever holder

	 <p>S-HCLNR/L A199 A-HCLNR/L A199</p>
	 <p>A-HXUNR/L A206</p>
	   <p>S-HDQNR/L A200 S-HDUNR/L A201 S-HDZNR/L A202 A-HDUNR/L A201 A-HDZNR/L A202</p>
	  <p>S-HTFNR/L A203 S-HTUNR/L A204 A-HTFNR/L A203 A-HTUNR/L A204</p>
	 <p>S-HWLNRL A205 A-HWLNRL A205</p>

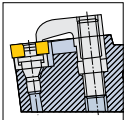

M Multi lock







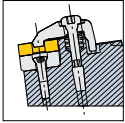











	 <p>S-MWLNRL A207</p>
---	--

Tool Selection Guide

Internal boring bars



T Holder

	 S-TCLNR/L A237 A-TCLNR/L A238	 A-TCLNR/L-TB A239
	 A-TXQNR/L A247	 A-TXUNR/L A247
	 S-TDUNR/L A240 A-TDUNR/L A240	 S-TDZNR/L A241 A-TDZNR/L A241
	 S-TSKNR/L A243 A-TSKNR/L A243	
	 S-TTFNR/L A244 A-TTFNR/L A244	 S-TTUNR/L A245 A-TTUNR/L A245
	 S-TWLNRL A246 A-TWLNRL A246	
	 A-THSNR/L A242	

Tool Selection Guide

Internal boring bars

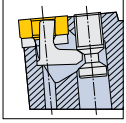

P Lever lock

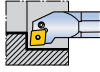

S-PCLNR/L A208

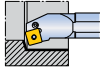

S-PSKNR/L A210

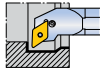

S-PDUNR/L A209



S-PDZNR/L A209

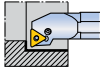

S-PTFNR/L A211

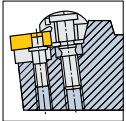

W Wedge clamp

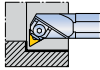

S-WTFNR/L A248

Tool Selection Guide

Internal boring bars

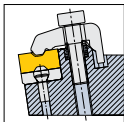

T-CH CH dimple holder



S-TCLNR/L-CH A249

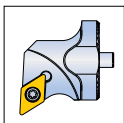

QH Modular head



QH-SCLCR/L A255



QH-SCLNR/L A256



QH-HCLNR/L A253



QH-SXUNR/L A262



QH-HDUNR/L A254



QH-SDUCR/L A257



QH-SDUNR/L A258



QH-HVUNR/L A254



QH-SVUBR/L A260













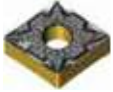

QH-STFCR/L A259













QH-SWLNRL A261

Tool Selection Guide





























Negative inserts





































		<i>T-TURN</i>				
Application	Super finishing			Finishing		
Chip breaker	FA	EA	FS	FLP	FG	
Insert						
Material	P	M S	P	P	P	
C 	• A269	• A268	• A270	• A270	• A270	
D 	• A277	• A277	• A278	• A278	• A278	
S 		• A286			• A287	
T 		• A292	• A293	• A293	• A293	
V 	• A297	• A297	• A299	• A298	• A298 A299	
W 		• A300	• A303	• A301	• A300 A303	
X 				• A305		
Y 			• A305			

		<i>T-TURN</i>				
Application	Finishing				Medium	
Chip breaker	SF	FX	FC	FM	MLP	
Insert						
Material	P M	P	P M	P	P	
C 	• A273		• A269	• A270	• A271	
D 			• A277	• A278	• A279	
S 			• A287	• A287		
T 	• A296		• A293	• A293	• A295	
V 		• A298 A299	• A297	• A299		
W			• A300	• A303	• A301	
X					• A305	
Y						

Tool Selection Guide















Negative inserts















T-TURN					
Application	Medium				
Chip breaker	MC	FT	VF	MGS	ML
Insert					
Material	P	P	P M	S	P M S
C	 <ul style="list-style-type: none"> • A271 	 <ul style="list-style-type: none"> • A270 		 <ul style="list-style-type: none"> • A271 	 <ul style="list-style-type: none"> • A266 A271
D	 <ul style="list-style-type: none"> • A279 	 <ul style="list-style-type: none"> • A278 	 <ul style="list-style-type: none"> • A281 	 <ul style="list-style-type: none"> • A279 	 <ul style="list-style-type: none"> • A276 A279
R					
S	 <ul style="list-style-type: none"> • A288 			 <ul style="list-style-type: none"> • A288 	 <ul style="list-style-type: none"> • A288
T	 <ul style="list-style-type: none"> • A294 	 <ul style="list-style-type: none"> • A294 	 <ul style="list-style-type: none"> • A296 		 <ul style="list-style-type: none"> • A294
V					 <ul style="list-style-type: none"> • A297 A298
W	 <ul style="list-style-type: none"> • A301 			 <ul style="list-style-type: none"> • A301 	 <ul style="list-style-type: none"> • A301
Y					

T-TURN					
Application	Medium				
Chip breaker	MP	EM	MK	MM	MGP
Insert					
Material	M S	M S	M S	P M	P
C	 <ul style="list-style-type: none"> • A271 	 <ul style="list-style-type: none"> • A269 	 <ul style="list-style-type: none"> • A271 	 <ul style="list-style-type: none"> • A271 	 <ul style="list-style-type: none"> • A271
D	 <ul style="list-style-type: none"> • A280 	 <ul style="list-style-type: none"> • A277 	 <ul style="list-style-type: none"> • A279 	 <ul style="list-style-type: none"> • A279 	 <ul style="list-style-type: none"> • A279
R					
S	 <ul style="list-style-type: none"> • A288 	 <ul style="list-style-type: none"> • A286 A287 	 <ul style="list-style-type: none"> • A288 	 <ul style="list-style-type: none"> • A288 	 <ul style="list-style-type: none"> • A288
T	 <ul style="list-style-type: none"> • A295 	 <ul style="list-style-type: none"> • A292 	 <ul style="list-style-type: none"> • A294 	 <ul style="list-style-type: none"> • A295 	 <ul style="list-style-type: none"> • A294
V		 <ul style="list-style-type: none"> • A297 	 <ul style="list-style-type: none"> • A299 		 <ul style="list-style-type: none"> • A298
W	 <ul style="list-style-type: none"> • A301 	 <ul style="list-style-type: none"> • A300 A303 	 <ul style="list-style-type: none"> • A304 	 <ul style="list-style-type: none"> • A304 	 <ul style="list-style-type: none"> • A301
Y					

Tool Selection Guide



























Negative inserts

		<i>T-TURN</i>					
Application		Medium			Roughing		
Chip breaker		PC	MT	MG-	ET	RGP	RT
Insert							
Material		P	P M K	P K	M S	P	P M K
C 		• A272	• A272	• A268	• A269	• A272	• A273
D 		• A280	• A280	• A276	• A277		• A280
R 				• A283			
S 		• A289	• A288 A289	• A286	• A287		• A288
T 		• A295 A296	• A295	• A291 A292	• A293		• A296
V 		• A298 A299	• A298 A299	• A297			
W 		• A302 A304	• A302 A304		• A300	• A302	• A302
Y 							

		<i>T-TURN</i>					
Application		Roughing					
Chip breaker		KT	RX	RH	EH	HT	HD
Insert							
Material		K	P	P	M	P	P
C 		• A270	• A275	• A275	• A274	• A267 A274	• A267
D 		• A278	• A281				
R 							
S 		• A287	• A290	• A290	• A289	• A285 A289	• A284
T 		• A294	• A296	• A296			
V 							
W 		• A301					
Y 							

Tool Selection Guide













Negative inserts













		<i>T-TURN</i>					
Application	Roughing		Finishing wiper		Medium wiper	Medium	
Chip breaker	HY	HZ	WS	WA	WT	GU	
Insert							
Material	P	P	P M K	P K	P M K S	P K	
C	 80° A267 A274	 80° A267 A274	 80° A273	 80° A273	 80° A266 A273		
D	 55°		 55° A281	 55° A281	 55° A281		
H	 120°					 120° A282	
S	 90° A285 A290	 90° A285 A290					
T	 60°			 60° A296			
V	 35°						
W	 80°		 80° A302	 80° A304	 80° A303		
Y	 25°						

		<i>T-TURN</i>			<i>POSSTURN</i>		
Application	Medium	Roughing	Medium	Finishing / Medium			
Chip breaker	SU	KNUX	DNUX	TNMV	XNMV	ZNMV	
Insert							
Material	P M	S P M	P M	P M	P K S	S P S	
C	 80°						
D	 55°		 55° A281				
H	 120° A282						
K	 90°	 90° A282					
T	 60°			 60° A306			
V	 35°						
X	 70°				 70° A306		
Z	 45°					 45° A307	

Tool Selection Guide















Positive inserts













		<i>T-TURN</i>																
Application		Super finishing			Finishing			Medium										
Chip breaker		FA		FG		FX	PC		FM									
Insert																		
Material		P	M			P	M		S	P		P	M		S	P	M	
C 			•			•						•					•	
		A312				A312	A313					A312	A313				A312	A313
D 		•				•						•					•	
		A317				A317						A317					A317	
R 												•						
												A320						
S 						•						•					•	
						A321						A321					A321	
T 		•				•						•					•	
		A325	A328			A325	A328					A325	A328				A325	A328
V 		•				•				•		•					•	
		A331				A331				A331		A331	A333				A331	A333
W 																		
F 																		

		<i>T-TURN</i>															
Application		Medium			Medium wiper			Roughing									
Chip breaker		MT		MGS		WT	PMR-		RA								
Insert																	
Material		P	M	K		M		S	P	M	K	P	M	K	S	P	
C 			•						•								
		A312							A312								
D 		•															
		A317															
R 		•				•											•
		A320				A320											A320
S 		•										•					
		A321										A322					
T 		•										•					
		A325										A328					
V 		•															
		A331															
W 																	
F 																	

Tool Selection Guide

Positive inserts

		<i>T-TURN</i>					
Application		Roughing		Finishing			
Chip breaker		CMX-	FF	GF	GW	FGS	FCMX
Insert							
Material		P	P M S	P M S	P M S	S	P
C			• A310	• A309	• A309		
D			• A315 A318	• A314 A318	• A314		
R		• A320					
S							
T			• A323 A326	• A324 A326			
V			• A330 A334	• A330 A334	• A330	• A331	
W			• A335				
F							• A319

		<i>T-TURN</i>					
Application		Finishing					
Chip breaker		SL	SA	SM	SH	FL	
Insert							
Material		P M S	P M S	P M S	P M S	M N S	
C		• A311	• A310	• A311	• A311	• A310	
D		• A316	• A315	• A316	• A316	• A315	
R						• A320	
S						• A321	
T			• A324			• A324	
V		• A330 A332	• A330 A332	• A330 A332		• A332	
W							
F							

Grades

Selection guide for turning grades

For steel (*SPEED RUSH* - CVD coated)

Cutting speed

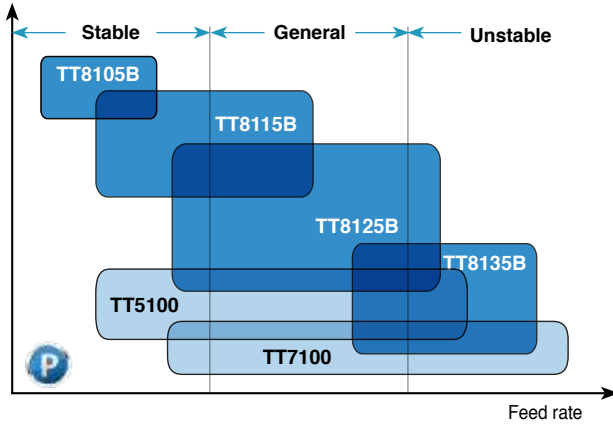

For stainless steel (CVD coated & PVD coated)

Cutting speed

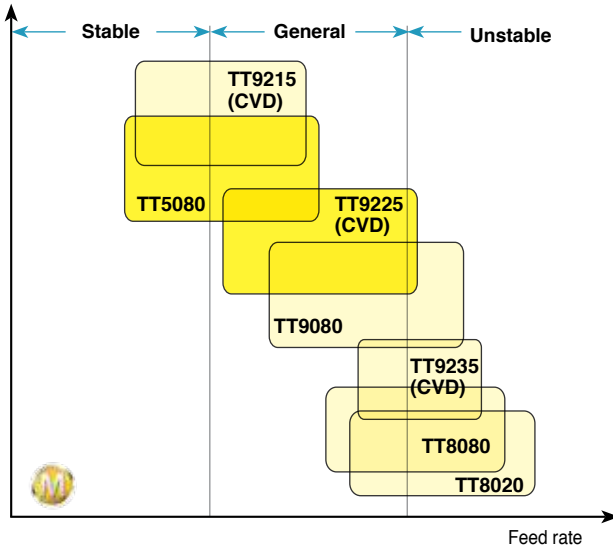

Grades

Selection guide for turning grades

For cast iron (CVD coated)

Cutting speed

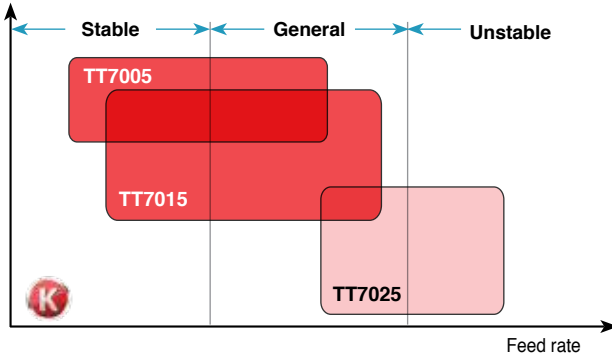

For super alloys (CVD & PVD coated)

Cutting speed

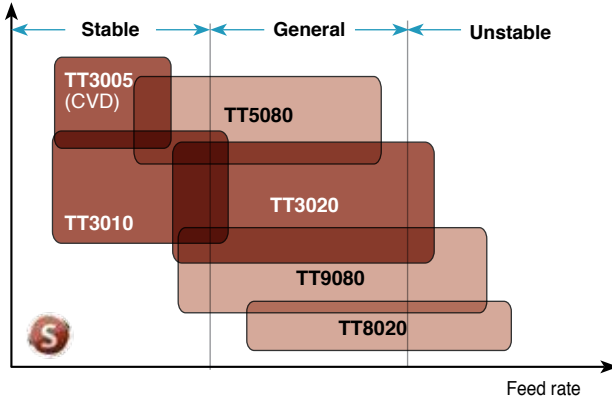

For small parts machining (PVD coated)

Cutting speed

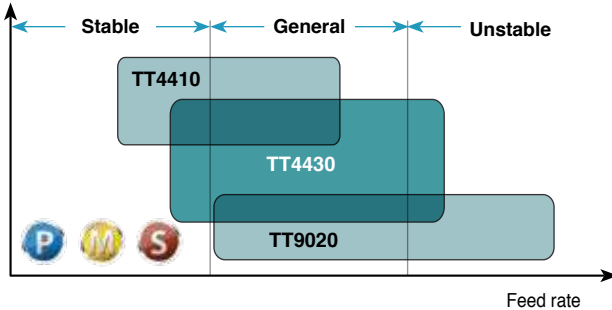

Grades

Carbide grades

Grades	ISO	Characteristics & applications
TT7005 CVD coated	K05 – K15	• High speed turning of gray cast iron in continuous conditions
TT7015 CVD coated	K10 – K25	• General turning of gray and ductile cast iron in continuous and interrupted conditions
TT7025 CVD coated	K20 – K35	• Interrupted turning of gray and ductile cast iron especially good in ductile cast iron
TT8105B CVD coated	P05 – P15	• High speed turning of steel in continuous conditions
TT8115B CVD coated	P05 – P20	• General turning of steel in high speed conditions
TT3005 CVD coated	S05 – S15	• Finish turning of heat resistant super alloys in high speed and low depth of conditions
TT9215 CVD coated	M05 – M20 S05 – S20	• High speed turning of stainless steel and heat resistant super alloys in continuous conditions
TT4410 PVD coated	M05 – M25 P05 – P25 S05 – S25	• High speed turning of small parts for stainless steel, steel and titanium alloys in continuous conditions
TT3010 PVD coated	S05 – S20	• High speed turning of heat resistant super alloys in continuous conditions
TT5080 PVD coated	M05 – M25 S05 – S25	• Wide range of turning for stainless steel and heat resistant super alloy
TT3020 PVD coated	S10 – S30	• General turning of heat resistant super alloy
TT8125B CVD coated	P15 – P30	• General turning of steel in wide range of conditions
TT5100 CVD coated	P20 – P35 M20 – M35	• Wide range of turning for mild steel, low carbon steel, low carbon alloy steel and stainless steel
TT9225 CVD coated	M15 – M30 S15 – S30	• General turning of stainless steel and heat resistant super alloy
TT9020 PVD coated	P20 – P40 M20 – M40	• General turning of small parts for steel and stainless steel

Grades

Carbide grades

Grades	ISO	Characteristics & applications
TT4430 PVD coated	M20 – M40 P20 – P40 S20 – S40	• General turning of small parts for stainless steel, steel and titanium alloy
TT9080 PVD coated	M20 – M40 P20 – P40 S20 – S40	• General turning of stainless steel, steel and heat resistant super alloy
TT8135B CVD coated	P25 – P40	• Interrupted turning of steel in low speed conditions
TT7100 CVD coated	P30 – P45	• Heavy interrupted turning of steel
TT9235 CVD coated	M25 – M40 S25 – S40	• Interrupted turning of stainless steel and heat resistant super alloy in low speed conditions
TT8080 PVD coated	M30 – M50 P30 – P50 S30 – S50	• Interrupted and rough turning of stainless steel and steel • Interrupted turning of heat resistant super alloys in low speed conditions
TT8020 PVD coated	M30 – M50 P30 – P50 S30 – S50	• Low speed turning of stainless steel, heat resistant super alloys and low carbon steel
PV3010 Cermet PVD coated	P05 – P20 M05 – M20 K05 – K20	• Good surface finish turning of steel, stainless steel and cast iron in high speed conditions
CT3000 Cermet uncoated	P10 – P20 M10 – M20 K10 – K20	• Excellent surface finish turning of steel, stainless steel and cast iron
K10 Carbide	K05 – K15 N05 – N15 S05 – S15	• General turning of cast iron, non-ferrous materials of aluminum and titanium alloy

Grades











CBN, PCD, Ceramic grades

Grades	ISO	Characteristics & applications
TB610 CBN	H05 – H10	• High speed continuous turning of hardened steel
TB2015 CBN	H10 – H20	• Light interrupted turning of hardened steel
TB650 CBN	H10 – H20	• General turning of hardened steel
TB670 CBN	H20 – H30	• Medium interrupted turning of hardened steel
TB7015 CBN	H25 – H35 K10 – K20	• High speed turning of cast iron and general turning of carbide roll
TB7020 Solid CBN	K10 – K25	• High speed and light interrupted turning of cast iron. Solid CBN insert
TB730 CBN	K05 – K10 P10 – P20	• General turning of sintered or powder metals
AW120 Ceramic, Al ₂ O ₃ +ZrO ₂	K05 – K15	• High speed continuous turning of white cast iron
AB2010 Ceramic, PVD coated	H05 – H10	• High speed finish turning of hardened steel
AB20 Ceramic, Al ₂ O ₃	H05 – H15	• Continuous and finish turning of hardened steel
AB30 Ceramic, Al ₂ O ₃	H10 – H15 K05 – K15	• General turning of hardened steel under HRC 55 and cast iron
TC430 Ceramic, Whisker	S05 – S15	• High speed turning of super alloys especially for Ni-based super alloy
TC3020 Ceramic, SiAlON	S15 – S25	• General turning and milling of super alloy
TC3030 Ceramic, SiAlON	S25 – S35	• Rough turning and milling of super alloy
AS500 Ceramic, SiAlON	K15 – K25	• General and light interrupted turning of gray cast iron
SC10 Ceramic CVD coated	K25 – K35	• General turning of ductile cast iron
AS10 Ceramic, Si ₃ N ₄	K25 – K35	• Interrupted turning of gray cast iron
TD810 PCD	N05 – N15	• Bi-modal composition for high speed turning of non-ferrous materials, high Si aluminum alloy, ceramic and sintered tungsten carbide
KP300 PCD	N10 – N25	• General turning of non-ferrous materials and finish turning of carbide roll
TD830 PCD	N20 – N35	• Low Si aluminum alloys and composite plastics (CFRP, GFRP)







Recommendations for Chip Breakers

ISO Negative inserts







For steel

	← Stable  Unstable →
Finishing	   
Medium	   
Roughing	 





For stainless steel

	← Stable  Unstable →
Finishing	
Medium	   
Roughing	



For super alloys

	← Stable  Unstable →
Finishing	
Medium	   
Roughing	

For cast iron

	← Stable  Unstable →
Finishing	
Medium	 
Roughing	 

For aluminum

	← Stable  Unstable →
Finishing	
Medium	 
Roughing	

Recommendations for Chip Breakers

RHINO-TURN Negative inserts

For steel

Finishing	
Medium	
Roughing	

For stainless steel

Finishing	
Medium	
Roughing	

For super alloys

Finishing	
Medium	
Roughing	

For cast iron

Finishing	
Medium	
Roughing	







For aluminum

Finishing	
Medium	
Roughing	





Recommendations for Chip Breakers

ISO Positive inserts



For steel

	← Stable  Unstable →
Finishing	  FA FG
Medium	   FM PC MT
Roughing	



For stainless steel

	← Stable  Unstable →
Finishing	  FA FG
Medium	 PC
Roughing	



For super alloys

	← Stable  Unstable →
Finishing	 FG
Medium	 PC
Roughing	

For cast iron

	← Stable  Unstable →
Finishing	
Medium	 MT
Roughing	



For aluminum

	← Stable  Unstable →
Finishing	
Medium	 GT-FL
Roughing	





Recommendations for Chip Breakers

Chip breakers for Swiss turn (Ground type)

RHINO-TURN Negative inserts

	← Stable	P	M	S	→ Unstable
Finishing		 VNGX-FS			
Finishing-Medium		 DNGG-FU			
Roughing		 GG-ML			









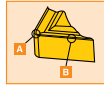











ISO Positive inserts

	← Stable	P	M	S	→ Unstable
Finishing		 SL			
Finishing-Medium		 SA	 SM		
Roughing		 SH			

Chip Breakers

Negative inserts









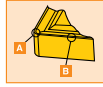

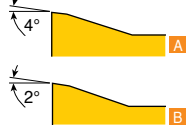

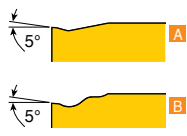
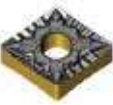
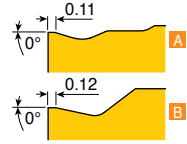
Chip breaker name and geometry		Applications and features
FA	 <p>CNMG 1204</p>  	<ul style="list-style-type: none"> • For super finish applications • Steel, stainless steel and heat resistant alloy machining • Excellent chip control
EA	 <p>CNMG 1204</p>  	<ul style="list-style-type: none"> • For finishing applications • Exotic materials • Excellent chip control at low feeds and depths of cut
FS	 <p>CNMG 0904</p>  	<ul style="list-style-type: none"> • Super finishing chip breaker for steel machining • Excellent chip control and chip evacuation • Minimal vibration due to less machining load
FLP	 <p>CNMG 1204</p>  	<ul style="list-style-type: none"> • For finishing applications for steel machining • Wide supporting area
FG	 <p>CNMG 1204</p>  	<ul style="list-style-type: none"> • For finish and semi finish applications • Steel, stainless steel and cast iron machining • Low cutting forces
SF	 <p>CNMG 1204</p>  	<ul style="list-style-type: none"> • For finishing applications • Stainless steel and heat resistant alloy machining • Low cutting forces
FX	 <p>VNMG 1604</p>  	<ul style="list-style-type: none"> • For finishing applications on mild steels • Narrow chip breaker design for optimal chip control

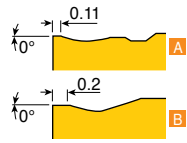
Chip Breakers

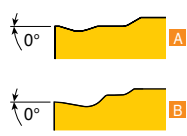
Negative inserts

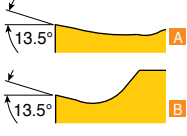

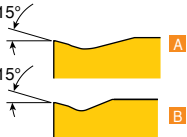





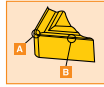





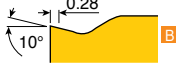







Chip breaker name and geometry		Applications and features
FC	 <p>CNMG 1204</p> 	<ul style="list-style-type: none"> • Ideal for finishing applications • Low carbon steel & low carbon alloy steel • Effective chip breaking in both turning and facing operations
FM	 <p>CNMG 0904</p> 	<ul style="list-style-type: none"> • For steel machining • Improved chip breaking due to 3dimension chipbreaker • Solution for a wide range from semi-finishing to semi-medium machining
MLP	 <p>CNMG 1204</p> 	<ul style="list-style-type: none"> • For semi-finishing and medium applications on steels • Wave cutting edge
MC	 <p>CNMG 1204</p> 	<ul style="list-style-type: none"> • For medium applications • Steel and cast iron machining • Strong rake geometry • Excellent chip control on medium turning applications
FT	 <p>CNMG 0904</p> 	<ul style="list-style-type: none"> • For steel machining • Strong, serrated cutting edge for excellent chip evacuation • Semi-finishing and medium machining • Excellent chip breaking for automotive components
VF	 <p>DNMG 1504</p> 	<ul style="list-style-type: none"> • For slender workpiece applications • Vibration free • Steel and stainless steel machining • High positive rake geometry to minimize cutting forces
MGS	 <p>CNMG 1204</p> 	<ul style="list-style-type: none"> • Low cutting resistance and heat generation in high-temperature alloy machining • High rake angle for smooth chip formation

Chip Breakers

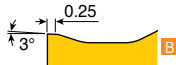
Negative inserts

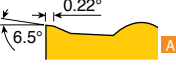







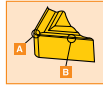





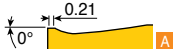
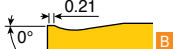





Chip breaker name and geometry		Applications and features
ML	 <p>CNMG 1204</p>  	<ul style="list-style-type: none"> • For medium light applications • Stainless steel, steel and aluminum • Very high positive rake geometry to minimize built-up-edge and cutting forces
MP	 <p>CNMG 1204</p>  	<ul style="list-style-type: none"> • For medium machining applications • Steel and stainless steel • High positive rake geometry to optimize machining and provide stable machining conditions
EM	 <p>CNMG 1204</p>  	<ul style="list-style-type: none"> • For medium applications • Stainless steel machining • Sharp land design for low cutting force
MK	 <p>CNMG 0904</p>  	<ul style="list-style-type: none"> • For medium applications • Stainless steel and heat resistant material machining • Sharp cutting edge to reduce built-up-edge
MM	 <p>CNMG 0904</p>  	<ul style="list-style-type: none"> • For general machining on stainless steel and steel • Positive rake angle provides excellent chip evacuation
MGP	 <p>CNMG 1204</p>  	<ul style="list-style-type: none"> • Wide range for medium application on steels • Wide groove and several dimples
PC	 <p>CNMG 1204</p>  	<ul style="list-style-type: none"> • For medium to semi-finishing applications • Steel & Automotive component • Positive geometry • Excellent chip control on medium applications

Chip Breakers

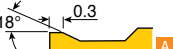
Negative inserts









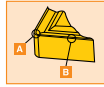

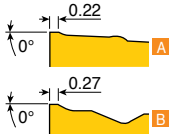

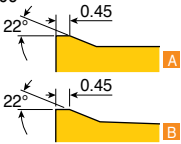

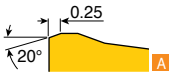
Chip breaker name and geometry		Applications and features
MT	 <p>CNMG 1204</p>  	<ul style="list-style-type: none"> • For medium rough applications • Steel, cast iron and stainless steel • Tough rake angle for general use
MG-	 <p>CNMG 1204</p>  	<ul style="list-style-type: none"> • For medium rough applications • Steel and cast iron machining • Strong rake geometry • Suitable for manual lathes
ET	 <p>CNMG 1204</p>  	<ul style="list-style-type: none"> • For roughing applications on exotic materials • Low cutting force • Wide chip control range when roughing
RGP	 <p>CNMG 1204</p>  	<ul style="list-style-type: none"> • For roughing applications on steels • Reliable cutting edge with low cutting force
RT	 <p>CNMG 1906</p>  	<ul style="list-style-type: none"> • For roughing applications • Steel and cast iron machining • Very strong rake geometry
KT	 <p>CNMG 1204</p>  	<ul style="list-style-type: none"> • For roughing applications on cast iron • Stable broad supporting area • Reliable, uniform performance
RX	 <p>CNMM 1906</p>  	<ul style="list-style-type: none"> • For semi heavy roughing applications • Steel, stainless steel and cast iron machining • Strong cutting edge with flat land • Low cutting force

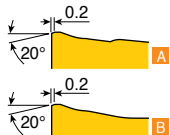
Chip Breakers

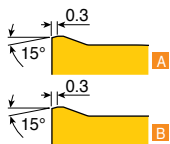

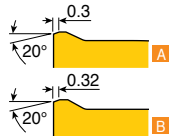
Negative inserts

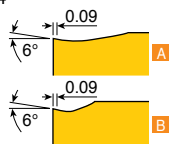

Chip breaker name and geometry		Applications and features
RH	 <p>CNMM 1906</p> 	<ul style="list-style-type: none"> • For roughing applications • Steel, stainless steel and cast iron machining • Very strong rake geometry
EH	 <p>CNMM 2509</p> 	<ul style="list-style-type: none"> • Heavy turning for stainless and mild steel • Low cutting force in stainless steel machining • Reliable & uniform performance • Excellent chip control due to the specially designed chip breaker geometry • Single sided insert
HT	 <p>CNMM 1906</p> 	<ul style="list-style-type: none"> • For heavy roughing applications • Low cutting force for low horse power machines • Excellent chip control due to changeable land and a flexible chip breaker
HD	 <p>CNMD 2509</p> 	<ul style="list-style-type: none"> • For heavy roughing applications • For all kinds of shafts, connecting-rods and ship building components • Flexible chip breaker offers excellent chip evacuation
HY	 <p>CNMM 2509</p> 	<ul style="list-style-type: none"> • For heavy roughing applications • For large depth of cut and high feed • Strong cutting edge credit to a wide land and large land angle
HZ	 <p>CNMM 2509</p> 	<ul style="list-style-type: none"> • For heavy roughing applications • For large depth of cut and high feed • Extremely strong cutting edge credit to a wide land and large land angle • Suitable for high cutting conditions
WS	 <p>wiper CNMG 1204</p> 	<ul style="list-style-type: none"> • For super finish applications • Steel, cast iron and stainless steel machining • Excellent chip control and low cutting forces

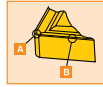
Negative inserts

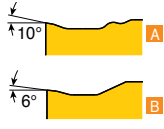

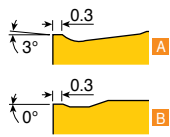

Chip breaker name and geometry		Applications and features
<p>WA</p>  <p><i>RHINO TURN</i></p>	<p>CNMG 0904</p> 	<ul style="list-style-type: none"> • For super finish applications • Steel, cast iron and stainless steel machining • Excellent surface roughness after machining
<p>WT</p> 	<p>CNMG 1204</p> 	<ul style="list-style-type: none"> • For medium to rough machining applications • Steel, cast iron and stainless steel machining • Stable cutting and low cutting forces at high feed rates

Chip Breakers

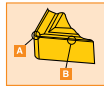
Negative inserts



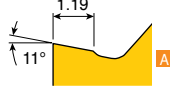

DNUX type

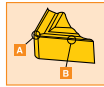
Chip breaker name and geometry		Applications and features
11	  DNUX 1304 	<ul style="list-style-type: none"> • For medium applications less than 5mm depth of cut • Steel and stainless steel machining • Positive rake geometry to decrease cutting forces • Suitable for turning slender bar, thin-wall components



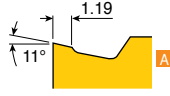

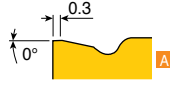
KNUX type

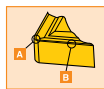
Chip breaker name and geometry		Applications and features
11	 KNUX 1604 	<ul style="list-style-type: none"> • For medium light to medium applications • Steel and stainless steel machining • Positive rake geometry to minimize cutting forces • Excellent chip control
12	 KNUX 1604 	<ul style="list-style-type: none"> • For medium to medium rough applications • Steel and stainless steel • Strong rake geometry • Wide chip control range



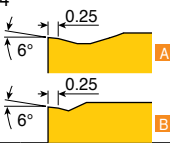

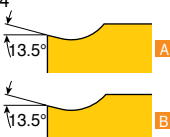





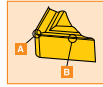



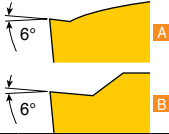

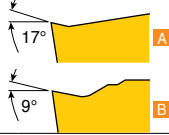

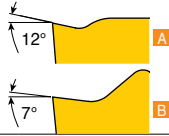
HNMG type

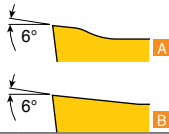
Chip breaker name and geometry		Applications and features
GU	 HNMG 0504 	<ul style="list-style-type: none"> • For medium applications • For general turning of steels and cast irons • Strong rake geometry
SU	 HNMG 0504 	<ul style="list-style-type: none"> • For exotic materials • Stainless steels, super alloys, low carbon steels, low carbon alloy steel machining • Sharp geometry to minimize built-up edge

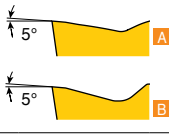
Chip Breakers

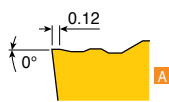
Positive inserts-pressed

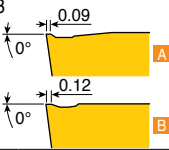



Chip breaker name and geometry		Applications and features
FA	 <p>DCMT 11T3</p> 	<ul style="list-style-type: none"> • For super finish applications • Very tight chipbreaker • Excellent chip control
FG	 <p>CCMT 09T3</p> 	<ul style="list-style-type: none"> • For finish to medium light applications • Steel and stainless steel machining • Low cutting forces • Excellent chip control
FX	 <p>VBMT 1604</p> 	<ul style="list-style-type: none"> • For finishing applications on mild steels • Narrow chip breaker design for optimal chip control
PC	 <p>CCMT 09T3</p> 	<ul style="list-style-type: none"> • For medium applications • Suitable for a wide variety of materials • Low cutting force
FM	 <p>CCMT 09T3</p> 	<ul style="list-style-type: none"> • Medium and semi-finishing machining for steel and stainless steel • Precision machining • Low cutting force chip breaker geometry
MT	 <p>CCMT 09T3</p> 	<ul style="list-style-type: none"> • For medium to medium rough applications • Steel, stainless steel and cast iron machining • Negative rake geometry for general use
WT	 <p>CCMT 09T3</p> 	<ul style="list-style-type: none"> • For medium to rough machining applications • Steel, cast iron and stainless steel machining • Stable cutting and low cutting forces at high feed rates
PMR-	 <p>TPMR 1103</p> 	<ul style="list-style-type: none"> • For medium to medium rough applications • Steel, stainless steel and cast iron • Positive rake geometry

Chip Breakers

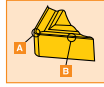

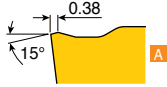

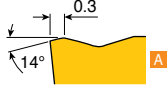

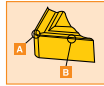

Positive inserts-pressed



Chip breaker name and geometry		Applications and features
RA	 <p>RCMX 3209</p> 	<ul style="list-style-type: none"> • For heavy and interrupted machining applications • Steel, stainless steel and cast iron machining • Optimized chip groove geometry
CMX-	 <p>RCMX 1204</p> 	<ul style="list-style-type: none"> • For high feed roughing applications • Steel, stainless steel and cast iron machining • Strong rake geometry

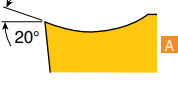

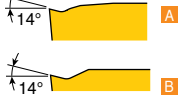

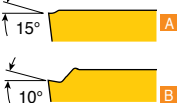



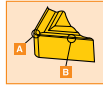

Positive inserts-ground

Chip breaker name and geometry		Applications and features
FF	 <p>CCGT 0301</p> 	<ul style="list-style-type: none"> • For finish to medium applications • For small component machining • Excellent surface finish
GF	 <p>CCET 0602</p> 	<ul style="list-style-type: none"> • For super finish applications • Steel, stainless steel and alloy steel machining
GW	 <p>CCET 0602</p> 	<ul style="list-style-type: none"> • For super finish applications • Wiper geometry for good surface finish • Steel, stainless steel and alloy steel machining
FGS	 <p>VBG 1604</p> 	<ul style="list-style-type: none"> • Lower cutting resistance and heat generation in heat resistant super alloys machining • High rake angle for smooth chip formation
SL	 <p>CCGT 09T3</p> 	<ul style="list-style-type: none"> • High performance in low depth of cut and low feed machining • Excellent chip segmentation due to wave geometry edge and special inclined design

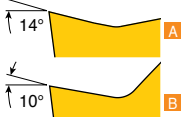
Chip Breakers

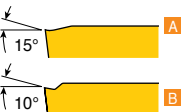
Positive inserts-ground

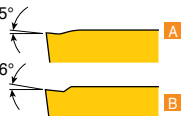

Chip breaker name and geometry		Applications and features
SA	 <p>CCGT 09T3</p> 	<ul style="list-style-type: none"> • For finish to medium applications • Steel & aluminum machining • Low cutting force
SM	 <p>CCGT 09T3</p> 	<ul style="list-style-type: none"> • 1st recommended chip breaker for Swiss type automatic lathe • Stable cutting edge and low cutting resistance
SH	 <p>CCGT 09T3</p> 	<ul style="list-style-type: none"> • Suitable for deep depth of cut machining • Excellent chip control in a wide machining range
FL	 <p>CCGT 1204</p> 	<ul style="list-style-type: none"> • For finish to medium applications • Aluminum machining • Very high positive rake geometry to minimize built-up-edge

Turning Toolholders



P **C** **L** **N** **R**

1 **2** **3** **4** **5**

1 Clamping system

Lever lock	Top clamp	Screw clamp	Multi lock	T-holder	Wedge clamp	Hook lever

2 Insert shape

C	D	E	H	K	R	S	T	V	W

3 Approach angle

Symbol	Shape	Offset	Symbol	Shape	Offset	Symbol	Shape	Offset
A		x	J		o	V		x
			K		o	W		o
B		x	L		o	X	Special angle	
			M		x	C*		x
D		x	N		x	H*		o
E		x	R		o	Q*		o
F		o	S		o			
G		o	T		o			
			U		o			

* TaeguTec standard

5 Hand of tool

R: Right hand
N: Neutral
L: Left hand

4 Insert clearance angle

N	B	C	P

25 **25** **M** **12** -

6 7 8 9 10 11

6 Shank height

Integers to be preceded by 0
e.g.: H=8mm indicated by 08

7 Shank width

Integers to be preceded by 0
e.g.: B=8mm indicated by 08

8 Tool length

LF (mm)	Symbol	LF (mm)	Symbol
32	A	160	N
40	B	170	P
50	C	180	Q
60	D	200	R
70	E	250	S
80	F	300	T
90	G	350	U
100	H	400	V
110	J	450	W
125	K	500	Y
140	L	Special	X
150	M		

9 Cutting edge length

See page A265

10 Qualified tool

11 Manufacturer's type designation

Unique to manufacturer

T-holder type **T**

- ① Insert
- ② Shim screw
- ③ Shim
- ④ Clamp screw
- ⑤ Clamp
- ⑥ Spring

Top clamp type **C**

- ① Insert
- ② Shim
- ③ Shim pin
- ④ Clamp set

Top clamp type **C**

- ① Insert
- ② Shim
- ③ Shim screw
- ④ Clamp
- ⑤ Clamp screw
- ⑥ Pin and spring
- ⑦ Clamp spring

Multi lock type **M**

- ① Insert
- ② Shim
- ③ Lock pin
- ④ Clamp
- ⑤ Clamp screw

Lever lock type **P**

- ① Insert
- ② Shim
- ③ Lever
- ④ Shim pin
- ⑤ Screw

Screw clamp type **S**

- ① Insert
- ② Shim
- ③ Screw
- ④ Shim screw

Wedge clamp type **W**

- ① Insert
- ② Shim
- ③ Pin screw
- ④ Wedge set

Ceramic T-holder **T**

- ① Insert
- ② Shim screw
- ③ Shim
- ④ Clamp screw
- ⑤ Clamp
- ⑥ Spring

Ceramic dimple holder **T**



- ① Insert
- ② Shim screw
- ③ Shim
- ④ Clamp screw
- ⑤ Clamp
- ⑥ Spring

Hook lever type **H**



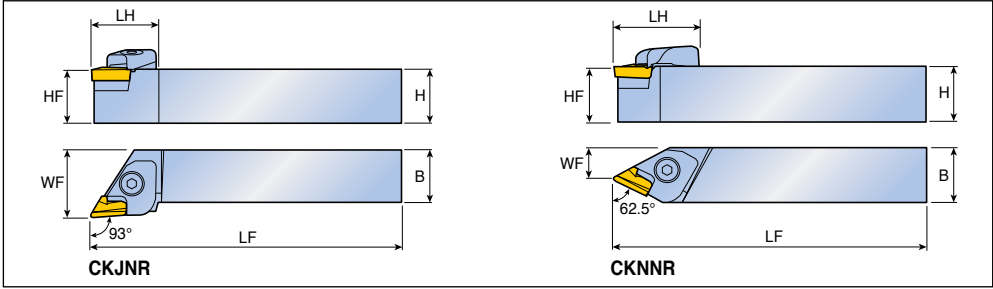

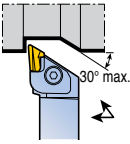

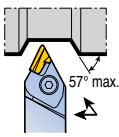

- ① Insert
- ② Shim pin
- ③ Shim
- ④ Hook lever
- ⑤ Screw

Top clamp type holders



Approach angle	Designation	Dimension (mm)						Insert
		H	HF	B	LF	LH	WF	
93° 	CKJNR/L 2020 K16	20	20	20	125	35	25	KNUX 1604...R/L 11 KNUX 1604...R/L 12  A282
	2020 M16	20	20	20	150	35	25	
	2525 M16	25	25	25	150	32	32	
	3225 P16	32	32	25	170	33.3	32	
	3232 M16	32	32	32	150	33.3	40	
	3232 P16	32	32	32	170	33.3	40	
	4040 R16	40	40	40	200	33.3	50	
62.5° 	CKNNR/L 2525 M16	25	25	25	150	44.7	14.4	
	3225 M16	32	32	25	150	44.7	14.4	

Spare parts

Designation	Clamp	Screw	Clamp spring	Pin	Pin spring	Shim	Shim screw	Wrench
...16	 CL 16KR/L	 CLS 16K	 KSP 90	 KP 48S	 KSP 48	 CSK 1604R/L	 FH M3x0.5x10	 L-W 4 L-W 2

Top clamp type holders

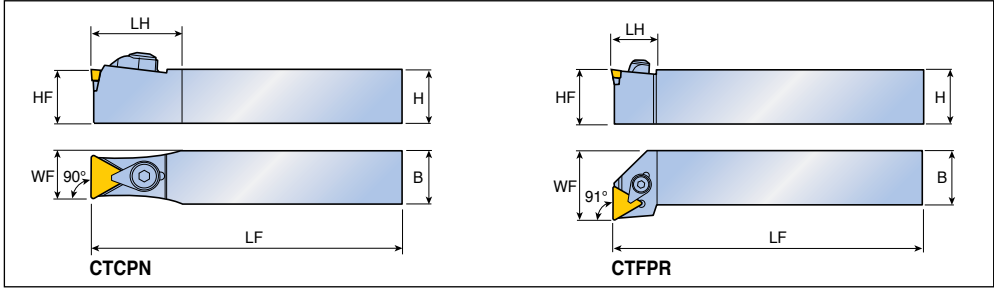

Approach angle	Designation	Dimension (mm)							Insert
		H	HF	B	LF	LH	WF		
90° 	CTCPN 2009 K11	20	20	9	125	20	9.4	TPMR,TP...N 1103...	
	2513 Q16	25	25	13	180	30	14.1	TPMR,TP...N 1603...	
	2525 M22	25	25	25	150	50	19.4	TPMR,TP...N 2204...	
91° 	CTFPR/L 1616 H11	16	16	16	100	14.4	20	TPMR,TP...N 1103...	
	2020 K11	20	20	20	125	16	25		
	2020 K16	20	20	20	125	20	25	TPMR,TP...N 1603...	
	2525 M16	25	25	25	150	20	32		

Spare parts

Designation	Clamp			Screw		Shim	Shim pin	Snap ring	Wrench
CTCPN ...11	CL 2C	-	-	CLS 2C	-	-	-	CSR 2C	L-W 2.5
CTCPN ...16	CL 3C	-	-	CLS 3C	-	CST 32	CSP 3	CSR 2	L-W 3
CTCPN ...22	-	CLM 12	-	-	XNSM 0825	CST 43	CSP 16K	CSR 4	L-W 4
CTFPR/L...11	-	-	CL 2	CLS 2	-	-	-	CSR 2	L-W 2.5
CTFPR/L...16	-	-	CL 3	CLS 3	-	CST 32	CSP 3	WSR 4	L-W 3

Top clamp type holders

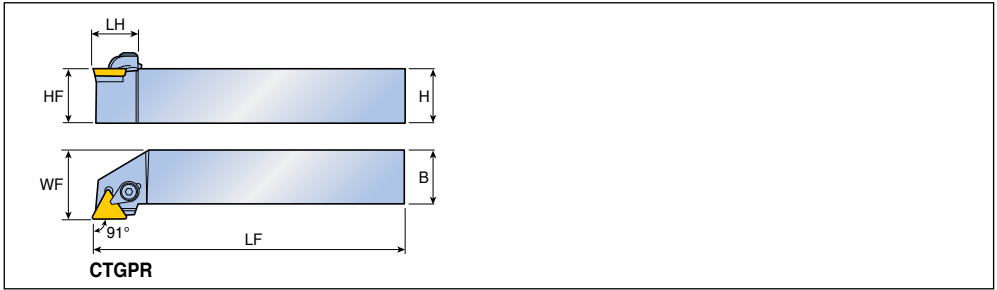

Approach angle	Designation	Dimension (mm)						Insert
		H	HF	B	LF	LH	WF	
91° 	CTGPR/L 1212 F11	12	12	12	80	19	16	TPMPR,TP...N 1103... A327-A329, A363, A364
	1616 H11	16	16	16	100	18	20	
	2020 K11	20	20	20	125	19	25	
	2020 K16	20	20	20	125	25	25	TPMPR,TP...N 1603...
	2525 M16	25	25	25	150	25	32	
	2525 M22	25	25	25	150	30	32	TPMPR,TP...N 2204...
3232 P22	32	32	32	170	30	40		

Spare parts



Designation	Clamp	Screw	Shim	Shim pin	Snap ring	Wrench		
...11	CL 2	CLS 2	-	-	CSR 2	L-W 2.5		
...16	CL 3	CLS 3	CST 32	CSP 3	WSR 4	L-W 3		
...22	CL 4	CLS 4	CST 43	CSP 16K	CSR 4	L-W 4		

HCLNR/L-RS HCLNR/L



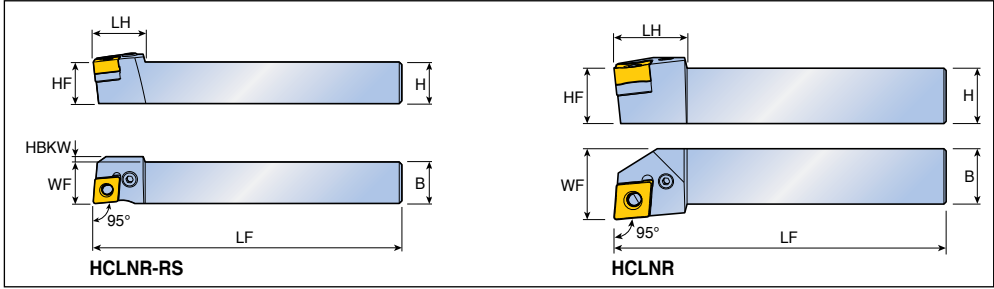

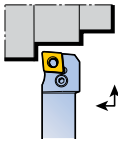

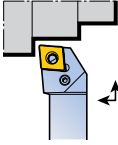

Hook lever type holders





Approach angle	Designation	Dimension (mm)							Insert
		H	HF	B	LF	LH	WF	HBKW	
 95°	HCLNR/L 1212 K0904-RS	12	12	16	125	18	12	2	CN... 0904...  A266, A268-A273
	1616 K0904-RS	16	16	16	125	20	16	-	
 95°	HCLNR/L 1616 H0904	16	16	16	100	22	20	-	CN... 0904... RHINOTURN
	2020 H0904	20	20	20	100	22	25	-	
	2020 K0904	20	20	20	125	22	25	-	
	2525 M0904	25	25	25	150	22	32	-	

Spare parts



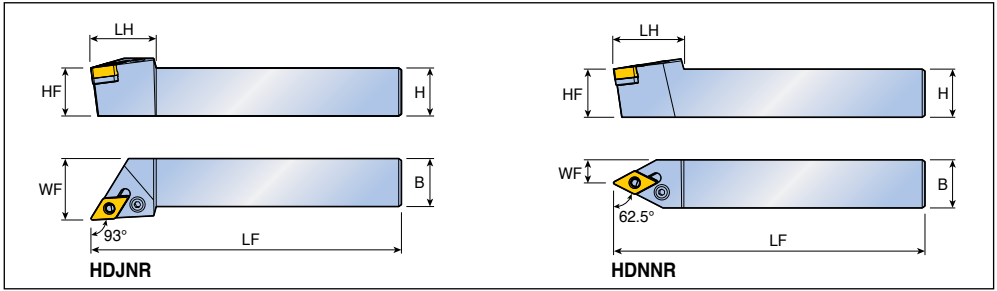

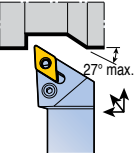
Designation	Lever	Screw	Snap ring	Shim	Shim pin	Wrench	
...1212...0904	 LCL 09B-NX	 LCS 3B	 LSR 3B	 -	 -	 L-W 2	
...0904	LCL 09-NX	LCS 3	-	LSC 32A	LSP 3A	L-W 2.5	

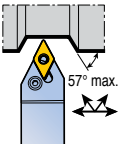
Hook lever type holders



Approach angle	Designation	Dimension (mm)						Insert
		H	HF	B	LF	LH	WF	
93° 	HDJNR/L 2020 H1305	20	20	20	100	34	25	DN... 1305...  A276-A281
	2020 K1305	20	20	20	125	34	25	
	2525 M1305	25	25	25	150	34	32	
62.5° 	HDNNR/L 2020 K1305	20	20	20	125	36.5	10	
	2525 M1305	25	25	25	150	36.5	12	

Spare parts



Designation	Lever	Screw	Shim	Shim pin	Wrench		
...1305	 LCL 11-NX	 LCS 4	 LSD 3.52	 LSP 4	 L-W 3		

HDQNR/L HDUNR/L



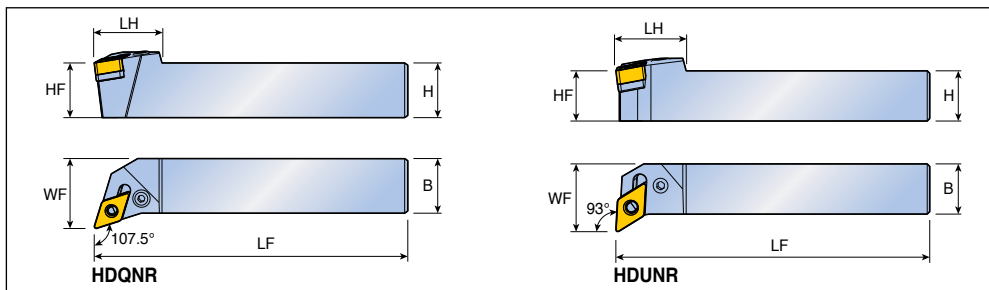

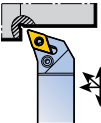

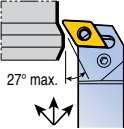
Hook lever type holders



Approach angle	Designation	Dimension (mm)						Insert
		H	HF	B	LF	LH	WF	
107.5° 	HDQNR/L 2020 K1305	20	20	20	125	31	25	DN... 1305...  A276-A281
	2525 M1305	25	25	25	150	31	32	
93° 	HDUNR/L 2020 K1305	20	20	20	125	28	27	

Spare parts

Designation	Lever	Screw	Shim	Shim pin	Wrench		
	...1305	 LCL 11-NX	 LCS 4	 LSD 3.52	 LSP 4	 L-W 3	

Hook lever type holders

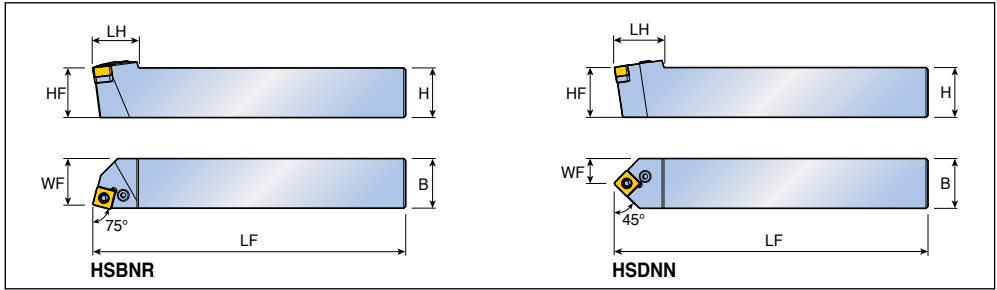

Approach angle	Designation	Dimension (mm)						Insert
		H	HF	B	LF	LH	WF	
75°	HSBNR/L 4040 S3109	40	40	40	250	55	35	SNMD 3109... A284, A285
	5050 T3109	50	50	50	300	55	43	
45°	HSDNN 4040 S3109	40	40	40	250	60	20	SNMD 3109...
	5050 T3109	50	50	50	300	60	25	

Spare parts

Designation	Lever	Screw	Shim	Shim pin	Wrench		
...3109	LCL 32-NX	LCS 8	LSS 104	LSP 8	L-W 5		

Hook lever type holders

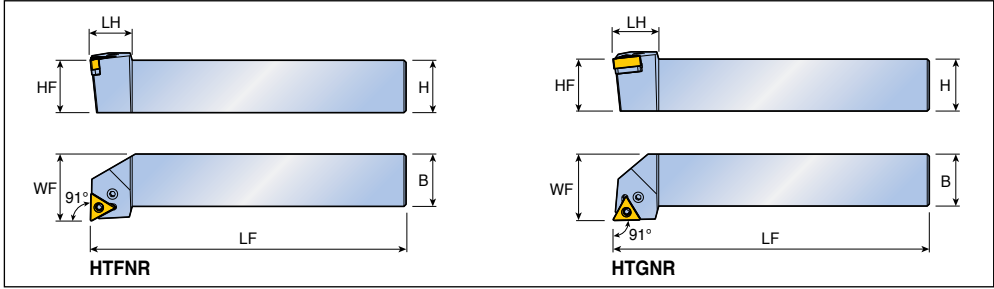

Approach angle	Designation	Dimension (mm)						Insert
		H	HF	B	LF	LH	WF	
91° 	HTFNR/L 2020 K1304	20	20	20	125	20	25	TN... 1304... A291-A296
	2525 M1304	25	25	25	150	20	32	
91° 	HTGNR/L 1616 H1304	16	16	16	100	22	20	
	2020 H1304	20	20	20	100	22	25	
	2020 K1304	20	20	20	125	22	25	
	2525 M1304	25	25	25	150	22	32	

Spare parts

Designation	Lever	Screw	Shim	Shim pin	Wrench		
	...						
...1304	LCL 08-NX	LCS 3-NX	LST 2.51.8	LSP 3B	L-W 2.5		

Hook lever type holders

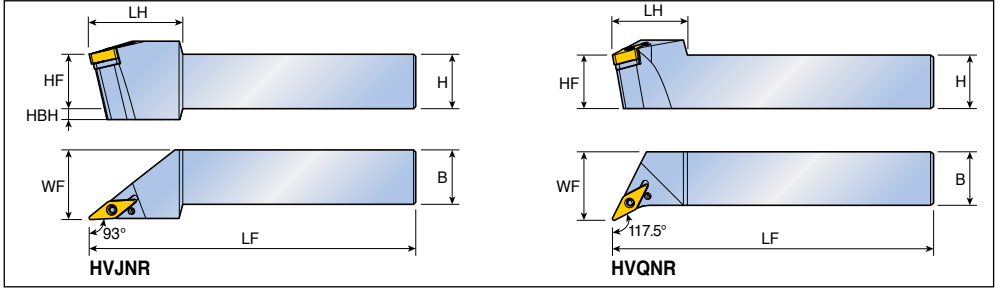

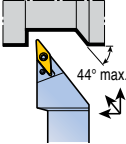
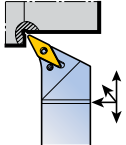
Approach angle	Designation	Dimension (mm)							Insert
		H	HF	B	LF	LH	WF	HBH	
93° 	HVJNR/L 1616 H1304	16	16	16	100	30	20	5	VN...X 1304... YNMG 1304... A297-A299, RHINO TURN A305
	2020 K1304	20	20	20	125	35	25	-	
	2525 M1304	25	25	25	150	43	32	-	
117.5° 	HVQNR/L 2020 K1304	20	20	20	125	35	25	-	
	2525 M1304	25	25	25	150	35	32	-	

Spare parts

Designation	Lever	Screw	Shim	Shim pin	Wrench			
...1304	LCL 08-NX	LCS 4-DH	LSV 2.51.8H	LSP 3B	L-W 2.5			

Hook lever type holders

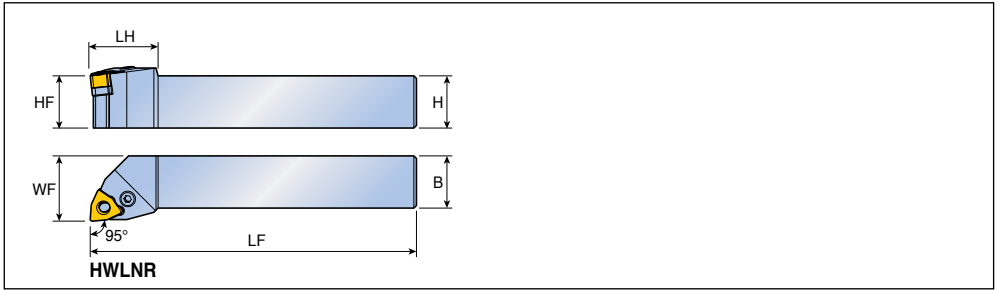





Approach angle	Designation	Dimension (mm)						Insert
		H	HF	B	LF	LH	WF	
95°	HWLNLR/L 1616 H0604	16	16	16	100	26	20	WN...X 0604... A303, A304
	2020 K0604	20	20	20	125	26	25	
	2525 M0604	25	25	25	150	26	32	

Spare parts

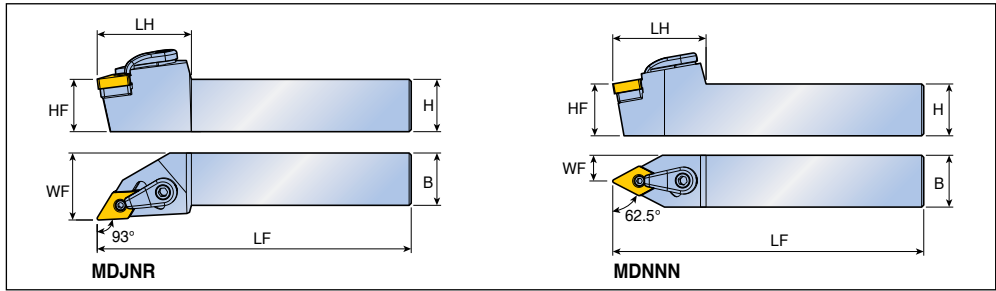

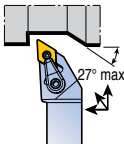



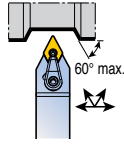



Designation	Lever	Screw	Shim	Shim pin	Wrench			
...0604	LCL 09-NX	LCS 3	LSW 32A	LSP 3A	L-W 2.5			

Multi lock type holders



Approach angle	Designation	Dimension (mm)						Insert
		H	HF	B	LF	LH	WF	
93° 	MDJNR/L 2020 K15	20	20	20	125	45	25	DN... 1504... 
	2525 M15	25	25	25	150	45	32	DN... 1506...  A276-A281,  A343, A354
	2020 K15A	20	20	20	125	45	25	
	2525 M15A	25	25	25	150	45	32	
	3232 P15A	32	32	32	170	45	40	
62.5° 	MDNNN 2525 M15	25	25	25	150	45	12.5	DN... 1504...
	3225 P15	32	32	25	170	45	12.5	DN... 1506...
	2525 M15A	25	25	25	150	45	12.5	

Spare parts

Designation	Clamp	Screw	Shim	Lock pin	Wrench			
...15	 CLM 30	 XNSM 0825	 S 45	 MLP 4	 L-W 2.5, L-W 4			
...15A	 CLM 30	 XNSM 0825	 MSD 43	 MLP 4-06	 L-W 2.5, L-W 4			

Multi lock type holders

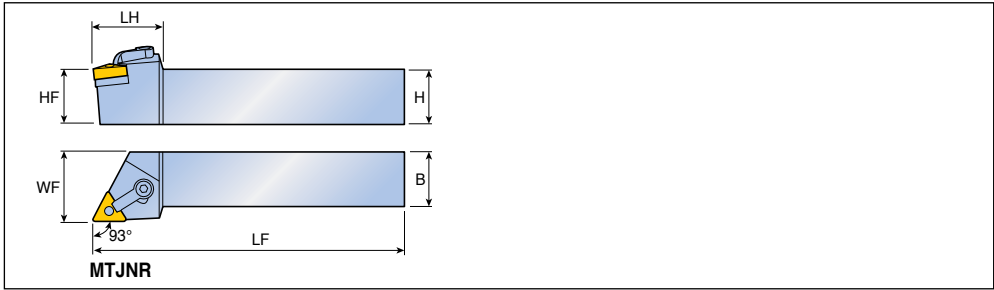



Approach angle	Designation	Dimension (mm)						Insert
		H	HF	B	LF	LH	WF	
93°	MTJNR/L 2020 K16	20	20	20	125	28	25	TN... 1603...
	2525 M16	25	25	25	150	28	32	A291-A296,
	2525 M1604	25	25	25	150	28	32	TN... 1604... A349, A357

Spare parts



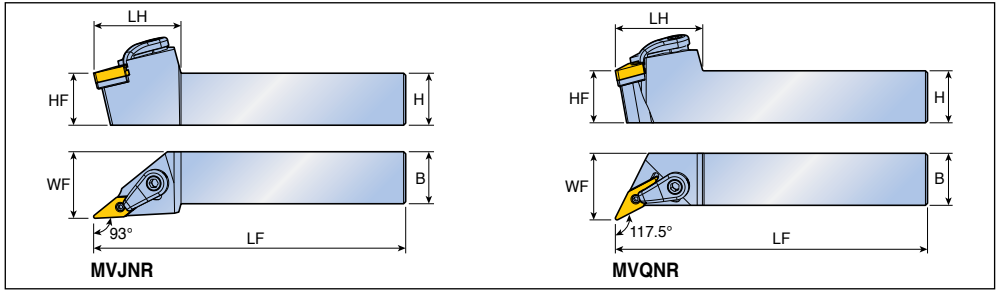

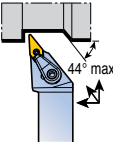
Designation	Clamp	Screw	Shim	Lock pin	Wrench			
...16	CLM 6	XNSM 0520	S 3	MLP 3	L-W 2, L-W 2.5			
...1604	CLM 6	XNSM 0520	S 31	MLP 3	L-W 2, L-W 2.5			

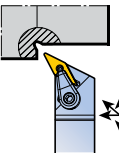
Multi lock type holders



Approach angle	Designation	Dimension (mm)						Insert
		H	HF	B	LF	LH	WF	
93° 	MVJNR/L 2020 K16	20	20	20	125	42	25	VN... 1604...  A297-A299, A350, A358
	2525 M16	25	25	25	150	42	32	
	3225 P16	32	32	25	170	42	32	
	3232 P16	32	32	32	170	42	40	
117.5° 	MVQNR/L 2020 K16	20	20	20	125	42	25	
	2525 M16	25	25	25	150	42	32	
	3232 P16	32	32	32	170	42	40	

Spare parts

Designation	Clamp	Screw	Shim	Lock pin	Wrench			
...16	 CLM 30	 XNSM 0825	 IVSN 324	 MLP 3	 L-W 2, L-W 4			

Lever lock type holders

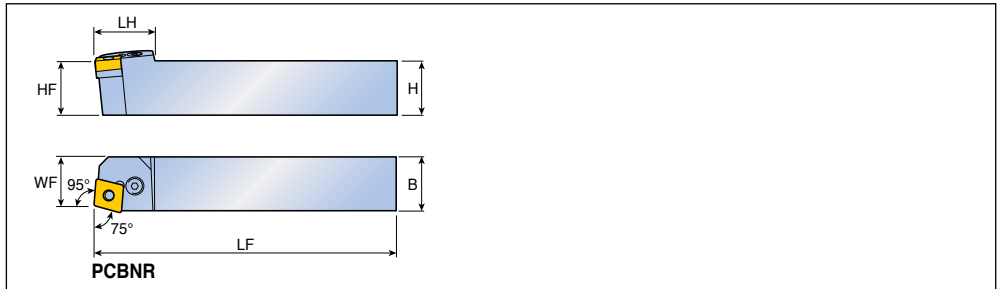

Approach angle	Designation	Dimension (mm)						Insert
		H	HF	B	LF	LH	WF	
75° 	PCBNR/L 2020 K12	20	20	20	125	28	17.5	CN... 1204... A266-A275, A341, A342, A353
	2525 M12	25	25	25	150	28	22.5	
	3225 P12	32	32	25	170	28	22.5	
	2525 M16	25	25	25	150	32	22	CN... 1606...
	3232 P16	32	32	32	170	32	27	
	3232 P1906D	32	32	32	170	37	27	CN... 1906...
	4040 S1906D	40	40	40	250	37	37	
	4040 S2509D	40	40	40	250	50	37	CN... 2509...
	5050 T2509D	50	50	50	300	50	47	

• CNMD, CNMM, CNMG type insert can be mounted on "-D" holder

Spare parts

Designation	Lever	Screw	Shim	Shim pin	Wrench			
...12	LCL 4	LCS 4	LSC 42	LSP 4	L-W 3			
...16	LCL 5	LCS 5	LSC 53	LSP 5	L-W 3			
...1906	LCL 6D	LCS 25C	LSC 64D	LSP 6	L-W 4			
...2509	LCL 8	LCS 8	LSC 84D	LSP 8	L-W 5			

• LSC 85D Shim can be used for CN...2507... insert

Lever lock type holders

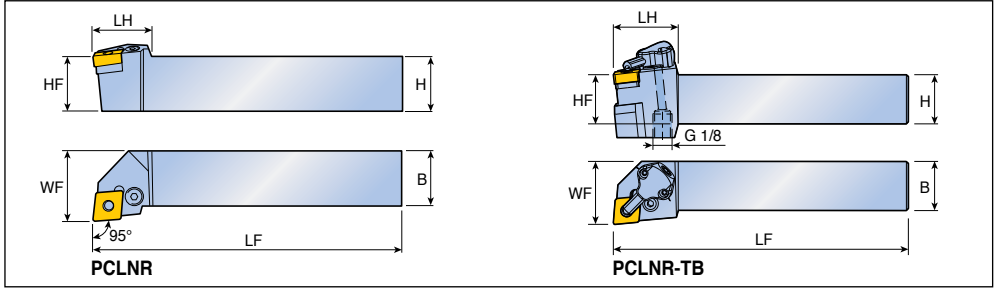

Approach angle	Designation	Dimension (mm)						Insert		
		H	HF	B	LF	LH	WF			
	PCLNR/L 1616 H12	16	16	16	100	27	20	CN... 1204... A266-A275, A341, A342, A353		
	2020 K12	20	20	20	125	27	25			
	2525 M12	25	25	25	150	27	32			
	3225 P12	32	32	25	170	27	32			
	3232 P12	32	32	32	170	27	40			
	2525 M16	25	25	25	150	33	32		CN... 1606...	
	3225 P16	32	32	25	170	33	32			
	3232 P16	32	32	32	170	33	40		CN... 1906...	
	2525 M1906D	25	25	25	150	38	32			
	3225 P1906D	32	32	25	170	38	32			
	3232 P1906D	32	32	32	170	38	40			
		4040 S1906D	40	40	40	250	38		50	CN... 2509...
		4040 S2509D	40	40	40	250	47		50	
		5050 T2509D	50	50	50	300	47		60	
PCLNR/L 2525 M12-TB		25	25	25	150	33	32	CN... 1204...		
3232 P12-TB		32	32	32	170	33	40			

• CNMD, CNMM, CNMG type insert can be mounted on "-D" holder

Spare parts

Designation	Lever	Screw	Shim	Shim pin	Cooling unit	O-ring	Wrench	
1616...12	LCL 4	LCS 4S	LSC 42	LSP 4	-	-	-	L-W 3
...12	LCL 4	LCS 4	LSC 42	LSP 4	-	-	-	L-W 3
...16	LCL 5	LCS 5	LSC 53	LSP 5	-	-	-	L-W 3
...1906	LCL 6D	LCS 25C	LSC 64D	LSP 6	-	-	-	L-W 4
...2509	LCL 8	LCS 8	LSC 84D	LSP 8	-	-	-	L-W 5
PCLNR/L...TB	LCS 4	LCS 4	LSC 42	LSP 4	CU-CW-TB	ID 6.4x0.9	T 8	L-W 2, L-W 3

- LSC 85D Shim can be used for CN...2507... insert
- Please refer to A164 page for COOL-BURST accessories

PDJNR/L PDJNR/L-TB



Lever lock type holders

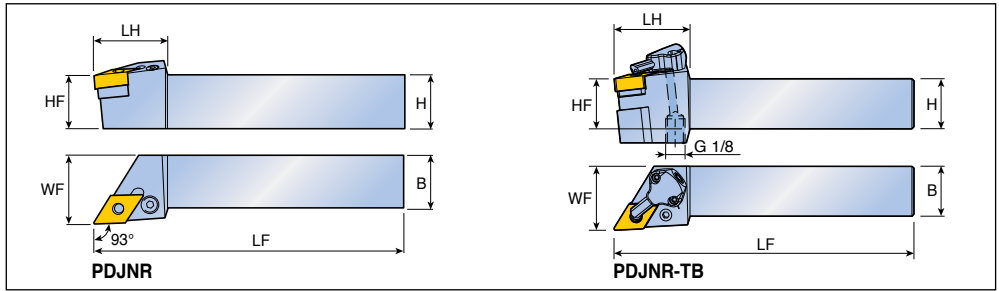

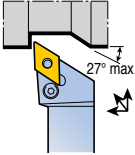
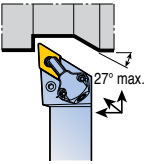
Approach angle	Designation	Dimension (mm)						Insert
		H	HF	B	LF	LH	WF	
93° 	PDJNR/L 1616 H11	16	16	16	100	30	20	DN... 1104...
	2020 K11	20	20	20	125	30	25	DN... 1506...
	2525 M11	25	25	25	150	30	32	
	2020 K15	20	20	20	125	34	25	DN... 1504...
	2525 M15	25	25	25	150	34	32	
	3225 P15	32	32	25	170	34	32	
	3232 P15	32	32	32	170	34	40	
	2020 K15A	20	20	20	125	34	25	
	2525 M15A	25	25	25	150	34	32	
93°  COOLBURST	PDJNR/L 2525 M1504-TB	25	25	25	150	37	32	DN... 1504...
	2525 M1506-TB	25	25	25	150	37	32	DN... 1506...

Spare parts

Designation	Lever	Screw	Shim	Shim pin	Cooling unit	O-ring	Wrench	
...11	LCL 12C	LCS 3	LSD 32	LSP 3A	-	-	-	L-W 2.5
...15	LCL 4A	LCS 4	LSD 42	LSP 4	-	-	-	L-W 3
...M1504-TB	LCL 4A	LCS 4	LSD 43	LSP 4	CU-D-TB	ID 6.4x0.9	T 8	L-W 2, L-W 3
...M1506-TB	LCL 4A	LCS 4	LSD 42	LSP 4	CU-D-TB	ID 6.4x0.9	T 8	L-W 2, L-W 3

• Please refer to A164 page for COOL-BURST accessories

Lever lock type holders

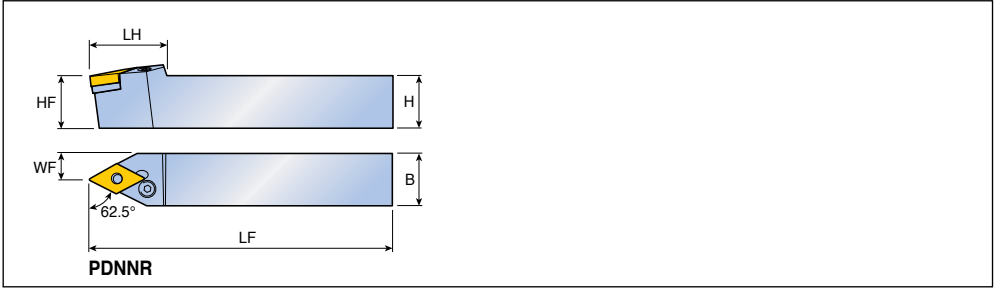

Approach angle	Designation	Dimension (mm)						Insert
		H	HF	B	LF	LH	WF	
62.5°	PDNNR/L 2020 K15	20	20	20	125	36.5	10	DN... 1506... A276-A281, A343, A354
	2525 M15	25	25	25	150	36.5	12	
	3232 P15	32	32	32	170	36.5	16.8	

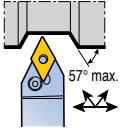

Spare parts

Designation	Lever	Screw	Shim	Shim pin	Wrench			
...15	LCL 4A	LCS 4	LSD 42	LSP 4	L-W 3			

Lever lock type holders

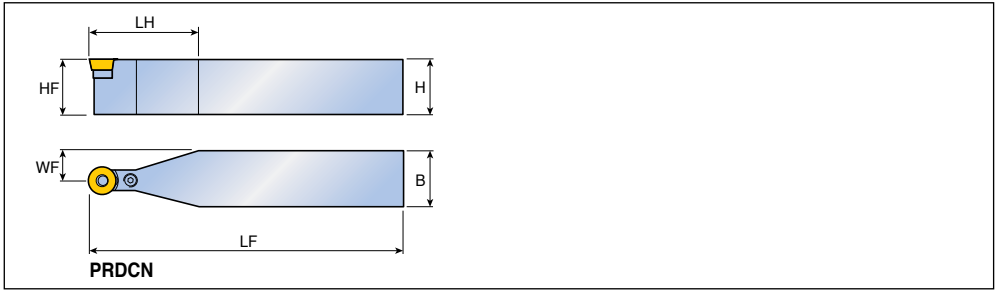

Approach angle	Designation	Dimension (mm)						Insert	
		H	HF	B	LF	LH	WF		
45° 	PRDCN	2020 M10	20	20	20	150	50	10.0	RC...X 1003... A320
		2525 M10	25	25	25	150	50	12.5	
		2020 K12	20	20	20	125	50	10.0	RC...X 1204...
		2525 M12	25	25	25	150	50	12.5	
		3225 Q12	32	32	25	180	50	12.5	RC...X 1606...
		2525 Q16	25	25	25	180	50	12.5	
		3225 Q16	32	32	25	180	50	12.5	RC...X 2006...
		3232 Q16	32	32	32	180	50	16.0	
		3232 S20	32	32	32	250	60	16.0	RC...X 2507...
		4040 S20	40	40	40	250	70	20.0	
		4040 S25	40	40	40	250	80	20.0	RC...X 3209...
		4040 T25	40	40	40	300	80	20.0	
		5050 U32	50	50	50	350	90	25.0	

Spare parts

Designation	Lever	Screw	Shim	Shim pin	Wrench			
...10	LCL 10C	LCS 2	LSR 32	LSP 3A	L-W 2			
...12	LCL 12C	LCS 3	LSR 1203	LSP 3A	L-W 2.5			
...16	LCL 16C	LCS 16C	LSR 1604	LSP 16C	L-W 2.5			
...20	LCL 20C	LCS 5	LSR 2004	LSP 5	L-W 3			
...25	LCL 25C	LCS 25C	LSR 2506	LSP 6	L-W 4			
...32	LCL 32C	LCS 8	LSR 3206	LSP 8	L-W 5			

Lever lock type holders

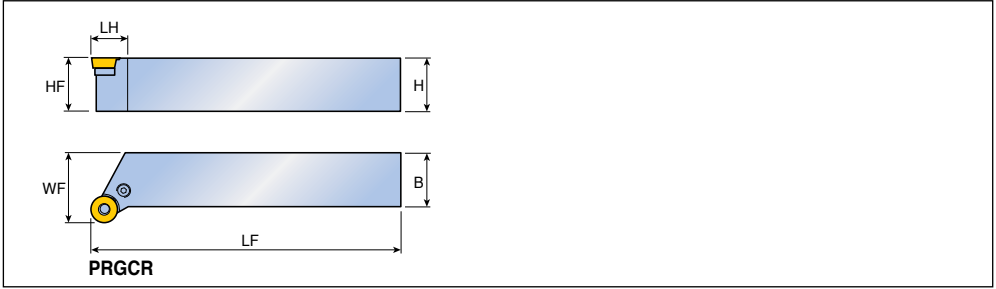

Approach angle	Designation	Dimension (mm)						Insert
		H	HF	B	LF	LH	WF	
<p>27° max.</p>	PRGCR/L 2020 K10	20	20	20	125	14.5	25	RC...X 1003... A320
	2525 M10	25	25	25	150	17.5	32	
	3225 P10	32	32	25	170	17	32	
	2020 K12	20	20	20	125	18	25	RC...X 1204...
	2525 M12	25	25	25	150	18	32	
	3225 P12	32	32	25	170	18	32	
	2525 M16	25	25	25	150	23	32	RC...X 1606...
	3225 P16	32	32	25	170	23	32	
	3232 P16	32	32	32	170	23	40	
	4040 P16	40	40	40	170	23	50	RC...X 2006...
	3232 P20	32	32	32	170	27.5	40	
	4040 S25	40	40	40	250	33.5	50	
	4040 S32	40	40	40	250	41	50	RC...X 2507...
								RC...X 3209...

Spare parts

Designation	Lever	Screw	Shim	Shim pin	Wrench			
...10	LCL 10C	LCS 2	LSR 32	LSP 3A	L-W 2			
...12	LCL 12C	LCS 3	LSR 1203	LSP 3A	L-W 2.5			
...16	LCL 16C	LCS 16C	LSR 1604	LSP 16C	L-W 2.5			
...20	LCL 20C	LCS 5	LSR 2004	LSP 5	L-W 3			
...25	LCL 25C	LCS 25C	LSR 2506	LSP 6	L-W 4			
...32	LCL 32C	LCS 8	LSR 3206	LSP 8	L-W 5			

Lever lock type holders

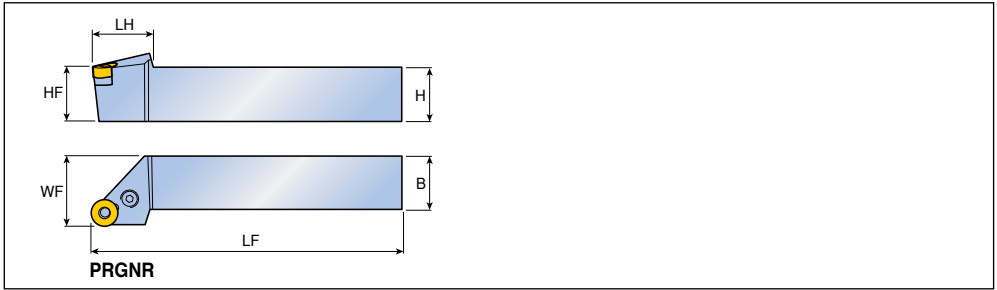

Approach angle	Designation	Dimension (mm)						Insert
		H	HF	B	LF	LH	WF	
90°	PRGNR/L 2525 M12	25	25	25	150	28	32	RNMG 120400
	3225 P15	32	32	25	170	35	32	RNMG 150600
	3232 P19	32	32	32	170	38	40	RNMG 190600

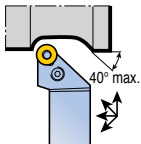



Spare parts

Designation	Lever	Screw	Shim	Shim pin	Wrench			
...09	LCL 3	LCS 3	LSR 32	LSP 3A	L-W 2.5			
...12	LCL 4	LCS 4	LSR 42	LSP 4	L-W 3			
...15	LCL 5	LCS 5	LSR 53	LSP 5	L-W 3			
...19	LCL 6D	LCS 6	LSR 63	LSP 6	L-W 4			

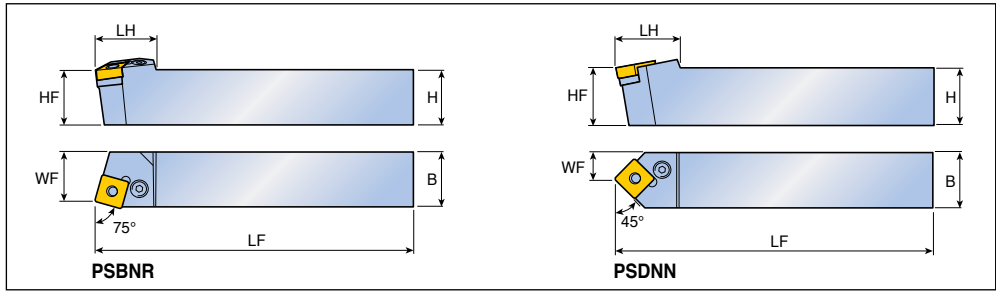
Lever lock type holders

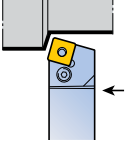

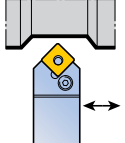
Approach angle	Designation	Dimension (mm)						Insert	
		H	HF	B	LF	LH	WF		
75° 	PSBNR/L	2020 K12	20	20	20	125	28	17	SN... 1204...  A284-A290, A346, A347, A356
		2525 M12	25	25	25	150	28	22	
		3225 P12	32	32	25	170	28	22	
		2525 M15	25	25	25	150	34	22	
		3232 P1906D	32	32	32	170	39	27	
		4040 S1906D	40	40	40	250	39	35	
		4040 S2509D	40	40	40	250	48	35	
		5050 T2509D	50	50	50	300	48	43	
45° 	PSDNN	2020 K12	20	20	20	125	28	10.0	SN... 1204...
		2525 M12	25	25	25	150	28	12.5	
		3225 P12	32	32	25	170	28	12.5	
		2020 K15	20	20	20	125	34	10.0	SN... 1506...
		2525 M15	25	25	25	150	34	12.5	
		3225 P1906D	32	32	25	170	40.5	12.5	SN... 1906...
		3232 P1906D	32	32	32	170	40.5	16.0	
		4040 S1906D	40	40	40	250	40.5	20.0	
		5050 S1906D	50	50	50	250	40.5	25.0	
		4040 S2509D	40	40	40	250	49	20.0	SN... 2509...
		5050 T2509D	50	50	50	300	49	25.0	

• SNMD, SNMM, SNMG type insert can be mounted on "-D" holder

Spare parts

Designation	Lever	Screw	Shim	Shim pin	Wrench			
...12	LCL 4	LCS 4	LSS 42	LSP 4	L-W 3			
...15	LCL 5	LCS 5	LSS 53	LSP 5	L-W 3			
...1906	LCL 6D	LCS 25C	LSS 64D	LSP 6	L-W 4			
...2509	LCL 8	LCS 8	LSS 84D	LSP 8	L-W 5			

• LSS 85D Shim can be used for SN... 2507... insert

Lever lock type holders

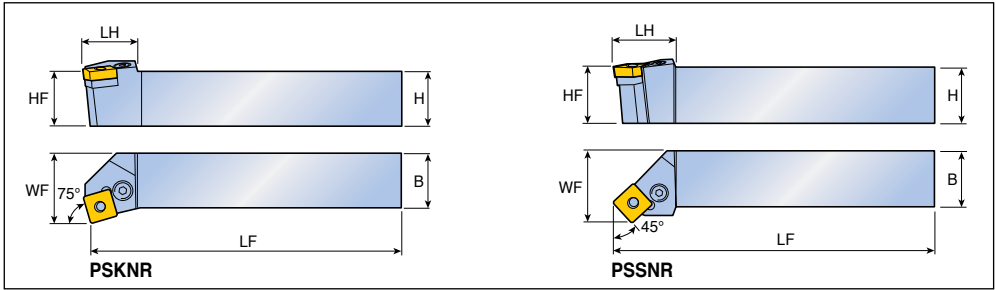

Approach angle	Designation	Dimension (mm)						Insert
		H	HF	B	LF	LH	WF	
	PSKNR/L 2020 K12	20	20	20	125	25	25	SN... 1204...
	2525 M12	25	25	25	150	25	32	SN... 1506... A284-A290, A346, A347, A356
	2525 M15	25	25	25	150	32	32	
	3232 P15	32	32	32	170	32	40	SN... 1906...
	3232 P1906D	32	32	32	170	38	40	SN... 1906...
	4040 S1906D	40	40	40	250	38	50	SN... 2509...
	4040 S2509D	40	40	40	250	42	50	SN... 2509...
	5050 T2509D	50	50	50	300	42	60	
	PSSNR/L 2020 K12	20	20	20	125	30	25	SN... 1204...
	2525 K12	25	25	25	125	30	32	SN... 1506...
	2525 M12	25	25	25	150	30	32	
	3225 P12	32	32	25	170	30	32	SN... 1906...
	3232 P12	32	32	32	170	32	40	SN... 1506...
	3232 P15	32	32	32	170	37	40	SN... 1906...
	3232 P1906D	32	32	32	170	42	40	SN... 2509...
	4040 S1906D	40	40	40	250	42	50	SN... 2509...
4040 S2509D	40	40	40	250	53	50		

• SNMD, SNMM, SNMG type insert can be mounted on "-D" holder

Spare parts

Designation	Lever	Screw	Shim	Shim pin	Wrench			
...12	LCL 4	LCS 4	LSS 42	LSP 4	L-W 3			
...15	LCL 5	LCS 5	LSS 53	LSP 5	L-W 3			
...1906	LCL 6D	LCS 25C	LSS 64D	LSP 6	L-W 4			
...2509	LCL 8	LCS 8	LSS 84D	LSP 8	L-W 5			

• LSS 85D Shim can be used for SN... 2507... insert

Lever lock type holders

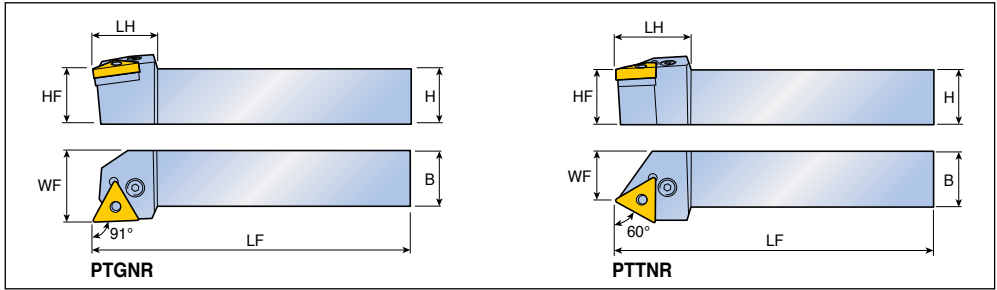

Approach angle	Designation	Dimension (mm)						Insert			
		H	HF	B	LF	LH	WF				
91° 	PTGNR/L	1010 E11	10	10	10	70	15	12	TN... 1103... A291-A296		
		1212 F11	12	12	12	80	15	16			
		2525 M11	25	25	25	150	30	32			
				1616 H16	16	16	16	100	22	20	TN... 1604...
				2020 K16	20	20	20	125	22	25	
				2525 M16	25	25	25	150	22	32	
				3232 P16	32	32	32	170	22	40	
				2525 M22	25	25	25	150	29	32	
				3232 P22	32	32	32	170	29	40	
								TN... 2204...			
60° 	PTTNR/L	1616 H16	16	16	16	100	24	13	TN... 1604...		
		2020 K16	20	20	20	125	24	17			
		2525 M16	25	25	25	150	24	22			

Spare parts

Designation	Lever	Screw	Shim	Snap ring	Shim pin	Wrench		
...11	LCL 2B	LCS 2B	-	LSR 2B	-	L-W 2		
...16	LCL 3	LCS 3	LST 31.8	-	LSP 3A	L-W 2.5		
...22	LCL 4	LCS 4	LST 42	-	LSP 4	L-W 3		

SCACR/L-SH SCACR/L-SH-TB



Screw type holders

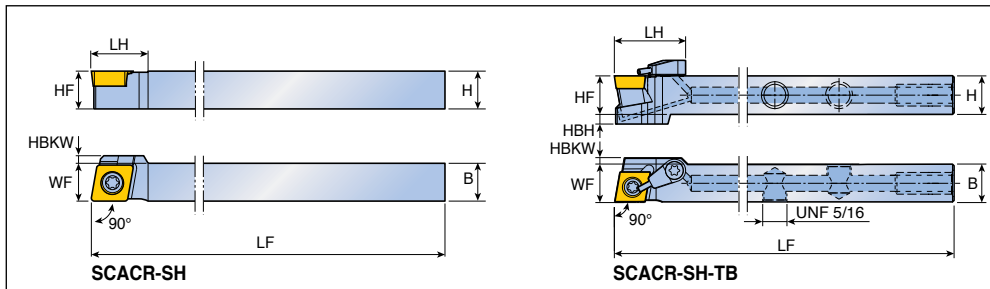

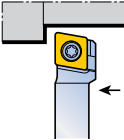
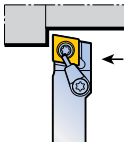



Approach angle	Designation	Dimension (mm)								Insert
		H	HF	HBH	B	LF	LH	WF	HBKW	
 90°	# SCACR/L 1010 K06-SH	10	10	-	10	125	10	10	-	CC... 0602...
	1010 K09-SH	10	10	-	10	125	15	10	2	CC... 09T3...
	1212 K09-SH	12	12	-	12	125	15	12	-	
	1616 K09-SH	16	16	-	16	125	16	16	-	
 90°	# SCACR/L 1212 K09-SH-TB	12	12	3	12	125	23	12	2	
	1616 K09-SH-TB	16	16	-	16	125	23	16	-	



 A309-A312,
 A360

• # Marked: TOP-MINI holders



Spare parts

Designation	Screw	Cooling unit	Plug	Wrench			
							
...06-SH	SO 25065l	-	-	T 7	-		
...09-SH	SO 35080l	-	-	T 15	-		
SCACR/L-SH-TB	SO 35080l	S-CU-TB	PLG 5/16 UNF	T 15	L-W 5/32		

• Please refer to A165 page for COOL-BURST accessories

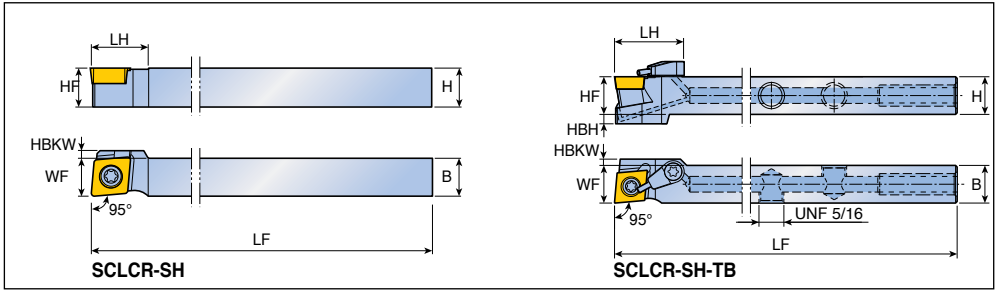

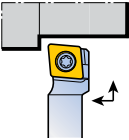

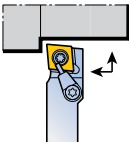
Screw type holders



Approach angle	Designation	Dimension (mm)								Insert
		H	HF	HBH	B	LF	LH	WF	HBKW	
95° 	# SCLCR/L 0808 K06-SH	8	8	-	8	125	8	8	-	CC... 0602...
	1010 K06-SH	10	10	-	10	125	10	10	-	
	1010 K09-SH	10	10	-	10	125	15	10	2	CC... 09T3...  A309-A312, A360
	1212 K09-SH	12	12	-	12	125	15	12	-	
	1616 K09-SH	16	16	-	16	125	16	16	-	
95°  COOLBURST	# SCLCR/L 1212 K09-SH-TB	12	12	3	12	125	23	12	2	
	1616 K09-SH-TB	16	16	-	16	125	23	16	-	

• # Marked: TOP-MINI holders

Spare parts

Designation	Screw	Cooling unit	Plug	Wrench			
							
...06-SH	SO 25065l	-	-	T 7	-		
...09-SH	SO 35080l	-	-	T 15	-		
SCLCR/L-SH-TB	SO 35080l	S-CU-TB	PLG 5/16 UNF	T 15	L-W 5/32		

• Please refer to A165 page for COOL-BURST accessories

Screw type holders

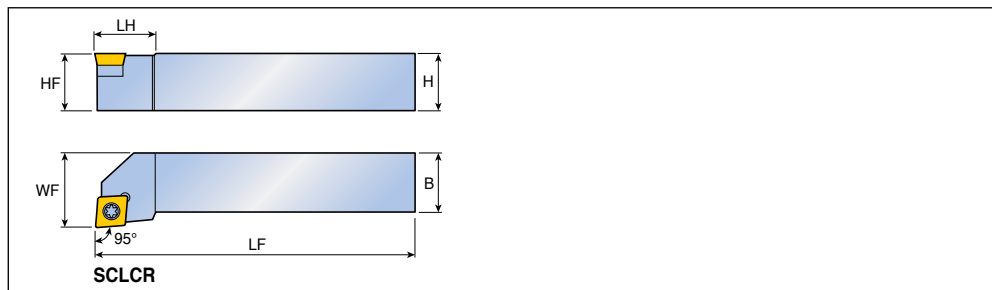

Approach angle	Designation	Dimension (mm)						Insert
		H	HF	B	LF	LH	WF	
	SCLCR/L 0808 F06	8	8	8	80	10	10	CC... 0602...
	1010 F06	10	10	10	80	10	12	
	1212 F09	12	12	12	80	16	16	
	1616 H09	16	16	16	100	16	20	
	2020 K09	20	20	20	125	20	25	
	2525 M09	25	25	25	150	20	32	
	2020 K12	20	20	20	125	25	25	CC... 1204...
	2525 M12	25	25	25	150	26	32	

Spare parts

Designation	Screw	Shim	Shim screw	Wrench			
...06	SO 25065I	-	-	T 7			
...F09	SO 35080I	-	-	T 15			
...09	SO 35124I	SSC 32	SO 50090S	T 15			
...12	SO 45130I	SSC 43N	SO 60105S	T 20			

Screw type holders

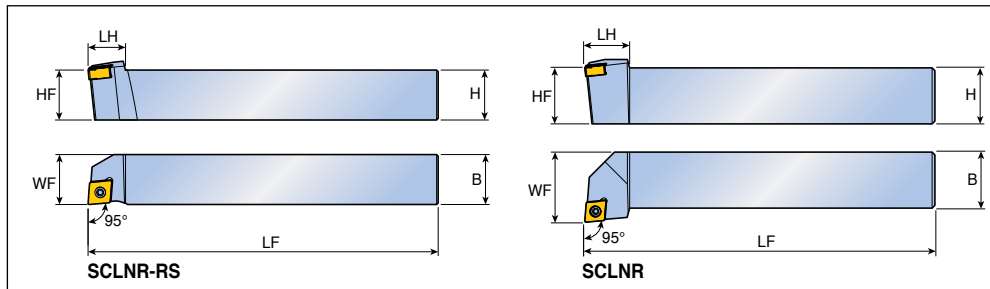





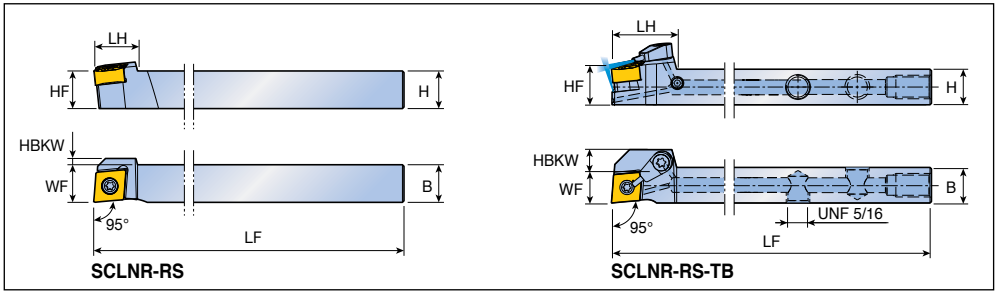

Approach angle	Designation	Dimension (mm)						Insert
		H	HF	B	LF	LH	WF	
95°	SCLNR/L 1212 K0703-RS	12	12	12	125	12	12	CNMX 0703... A275
	1616 K0703-RS	16	16	16	125	12	16	
95°	SCLNR/L 1616 H0703	16	16	16	100	12	20	
	2020 K0703	20	20	20	125	16	25	

Spare parts

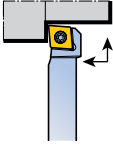

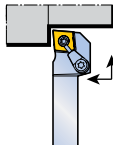

Designation	Screw	Wrench				
	...0703...	TS 25D060/HG-P	T 7P			

Screw type holders



Approach angle	Designation	Dimension (mm)							Insert
		H	HF	B	LF	LH	WF	HBKW	
	SCLNR 1212 K0904-RS	12	12	12	125	14	12	2	CN... 0904  RHINO TURN  A266, A268-A273
	1616 K0904-RS	16	16	16	125	14	16	-	
	2020 K0904-RS	20	20	20	125	14	20	-	
 	SCLNR 1212 K0904-RS-TB	12	12	12	125	22	12	6	CN... 0904  RHINO TURN  A266, A268-A273
	1616 K0904-RS-TB	16	16	16	125	22	16	2	
	2020 K0904-RS-TB	20	20	20	125	22	20	-	



Spare parts

Designation	Screw	Cooling unit	Plug	Wrench			
							
SCLNR-RS	TS 35083I/HG	-	-	T 10	-		
SCLNR-RS-TB	TS 35083I/HG	S-CU-TB	PLG 5/16 UNF	T 10	L-W 5/32		

• Please refer to A165 page for COOL-BURST accessories

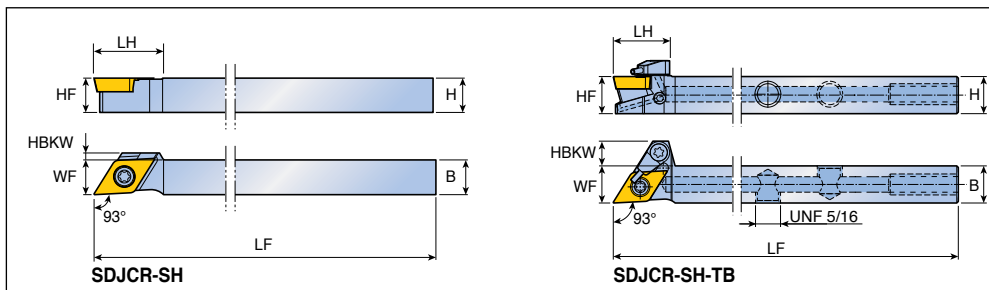

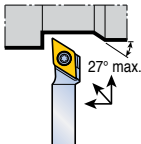

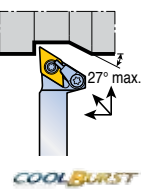
Screw type holders



Approach angle	Designation	Dimension (mm)							Insert
		H	HF	B	LF	LH	WF	HBKW	
93° 	# SDJCR/L 0808 K07-SH	8	8	8	125	12.7	8	-	DC... 0702...  DC... 11T3...  A314-A317, A361
	1010 K07-SH	10	10	10	125	15	10	-	
	1010 K11-SH	10	10	10	125	20	10	2	
	1212 K11-SH	12	12	12	125	20	12	-	
	1616 K11-SH	16	16	16	125	20	16	-	
	2020 K11-SH	20	20	20	125	20	20	-	
93° 	# SDJCR/L 1212 K11-SH-TB	12	12	12	125	19	12	8	
	1616 K11-SH-TB	16	16	16	125	19	16	4	
	2020 K11-SH-TB	20	20	20	125	20	20	-	

• # Marked: TOP-MINI holders

Spare parts

Designation	Screw	Cooling unit	Plug	Wrench		
						
...07	SO 25065I	-	-	T 7	-	
...11-SH	SO 35080I	-	-	T 15	-	
SDJCR/L-SH-TB	SO 35080I	S-CU-TB	PLG 5/16 UNF	T 15	L-W 5/32	

• Please refer to A165 page for COOL-BURST accessories

Screw type holders

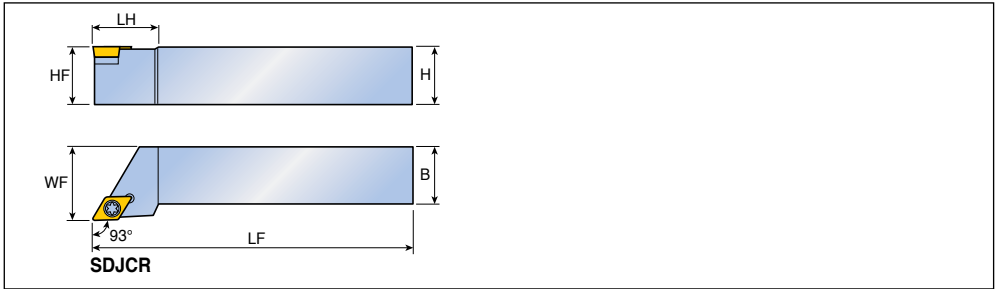

Approach angle	Designation	Dimension (mm)						Insert
		H	HF	B	LF	LH	WF	
93°	SDJCR/L 1212 F07	12	12	12	80	15	16	DC... 0702... A314-A317, A361 DC... 11T3...
	1616 H07	16	16	16	100	15	20	
	2020 K07	20	20	20	125	20	25	
	1616 H11	16	16	16	100	24	20	
	2020 K11	20	20	20	125	24	25	
	2525 M11	25	25	25	150	28	32	

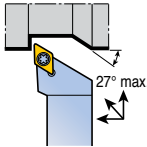

Spare parts

Designation	Screw	Shim	Shim screw	Wrench				
...07	SO 250651	-	-	T 7				
...11	SO 351241	SSD 32	SO 50090S	T 15				

Screw type holders

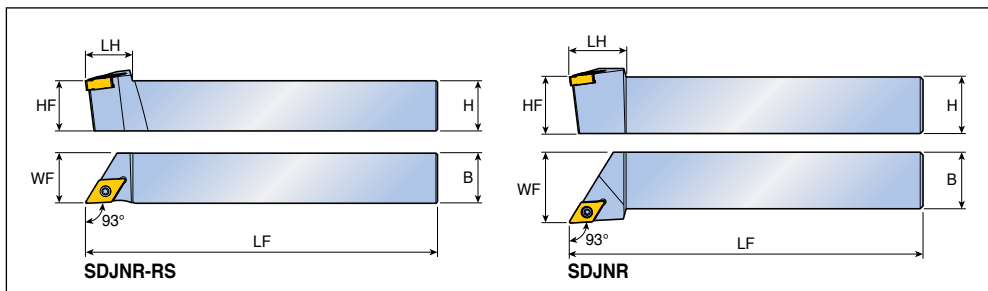



Approach angle	Designation	Dimension (mm)						Insert
		H	HF	B	LF	LH	WF	
93° 	SDJNR/L 1212 K0803-RS	12	12	12	125	15	12	DN...X 0803... A276, A281
	1616 K0803-RS	16	16	16	125	15	16	
93° 	SDJNR/L 1616 H0803	16	16	16	100	16	20	DN... 1104... A276-A278, A280
	2020 K0803	20	20	20	125	20	25	
	SDJNR/L 1616 H11	16	16	16	100	25	20	
	2020 K11	20	20	20	125	25	25	
	2525 M11	25	25	25	150	25	32	

Spare parts



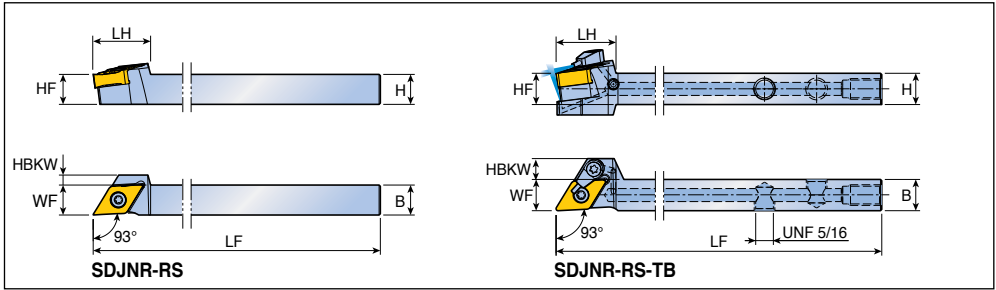

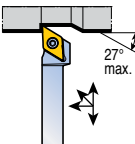
Designation	Screw	Shim	Shim screw	Wrench			
...0803...	TS 25D060/HG-P	-	-	T 7P			
...1104...	SO 35120I	SSD 32	SO 50090S	T 10			

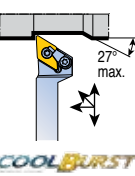
Screw type holders



Approach angle	Designation	Dimension (mm)							Insert
		H	HF	B	LF	LH	WF	HBKW	
93° 	SDJNR 1212 K1305-RS	12	12	12	125	23	12	4	DN... 1305...   A276-A281
	1616 K1305-RS	16	16	16	125	23	16	-	
	2020 K1305-RS	20	20	20	125	23	20	-	
93° 	SDJNR 1212 K1305-RS-TB	12	12	12	125	23	12	8	
	1616 K1305-RS-TB	16	16	16	125	23	16	4	

Spare parts

Designation	Screw	Cooling unit	Plug	Wrench				
								
SDJNR-RS	TS 40G110I	-	-	T 15	-			
SDJNR-RS-TB	TS 40G110I	S-CU-TB	PLG 5/16 UNF	T 15	L-W 5/32			

• Please refer to A165 page for COOL-BURST accessories

Screw type holders

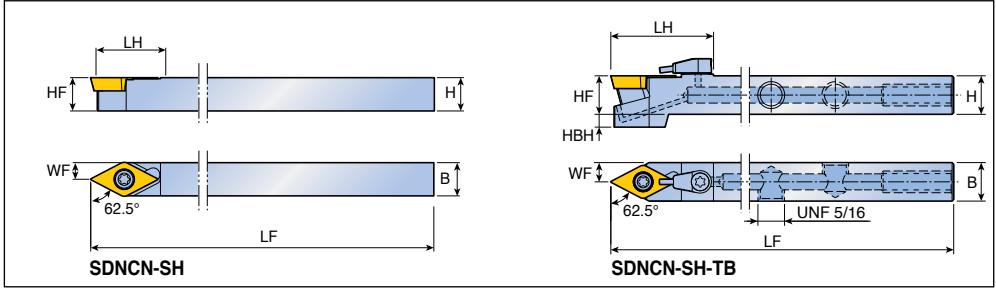

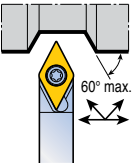
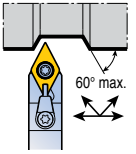
Approach angle	Designation	Dimension (mm)							Insert
		H	HF	HBH	B	LF	LH	WF	
62.5° 	# SDNCN 0808 K07-SH	8	8	-	8	125	15	4	DC... 0702... A314-A317,
	1010 K07-SH	10	10	-	10	125	15	5	
	1010 K11-SH	10	10	-	10	125	22	5	DC... 11T3... A361
	1212 K11-SH	12	12	-	12	125	22	6	
	1616 K11-SH	16	16	-	16	125	22	8	
62.5°  COOLBURST	# SDNCN 1212 K11-SH-TB	12	12	4	12	125	32	6	
	1616 K11-SH-TB	16	16	-	16	125	32	8	

• # Marked: TOP-MINI holders

Spare parts

Designation	Screw	Cooling unit	Plug	Wrench				
...07	SO 25065I	-	-	T 7	-			
...11-SH	SO 35080I	-	-	T 7	-			
SDNCN-SH-TB	SO 35080I	S-CU-TB	PLG 5/16 UNF	T 15	L-W 5/32			

• Please refer to A165 page for COOL-BURST accessories

Screw type holders

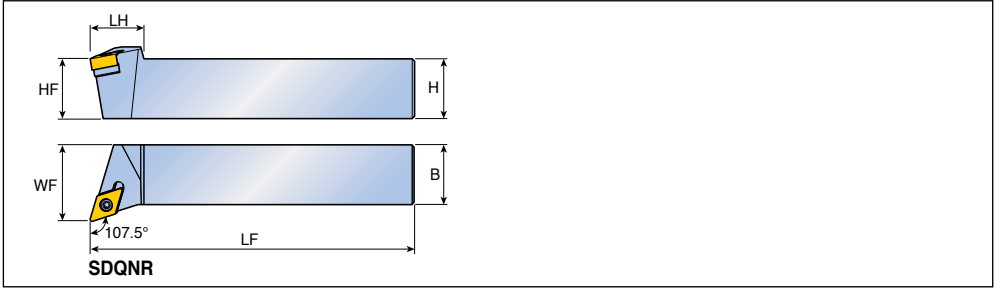

Approach angle	Designation	Dimension (mm)						Insert
		H	HF	B	LF	LH	WF	
107.5°	SDQNR/L 1616 H11	16	16	16	100	22	20	DN... 1104... A276-A278, A280
	2020 K11	20	20	20	125	22	25	
	2525 M11	25	25	25	150	22	32	

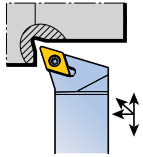

Spare parts

Designation	Screw	Shim	Shim screw	Wrench			
...11	SO 35120I	SSD 32	SO 50090S	T 10			

Screw type holders for FCMX high feed inserts

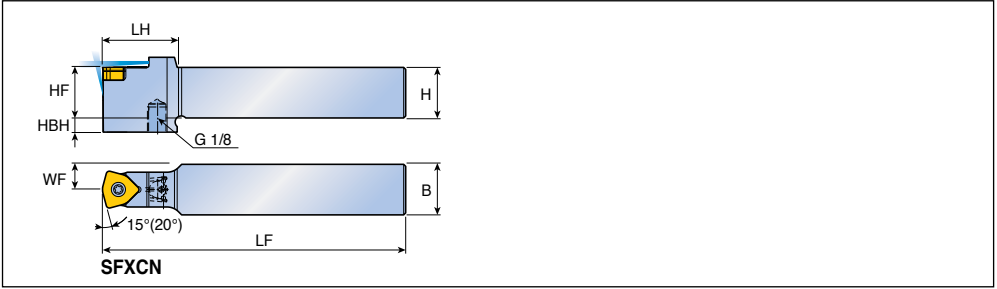

Approach angle	Designation	Dimension (mm)								Insert
		H	HF	B	LF	LH	WF	HBH		
15°	SFXCN 2525 M1006	25	25	25	150	37	12.5	7	FCMX 1006... A319	
	3232 P1006	32	32	32	170	37	16	-		
15° FCMX HFG										
20° FCMX HFP										

Spare parts

Designation	Screw	Wrench					
...1006	SO 45130I	T 20					

Screw type holders

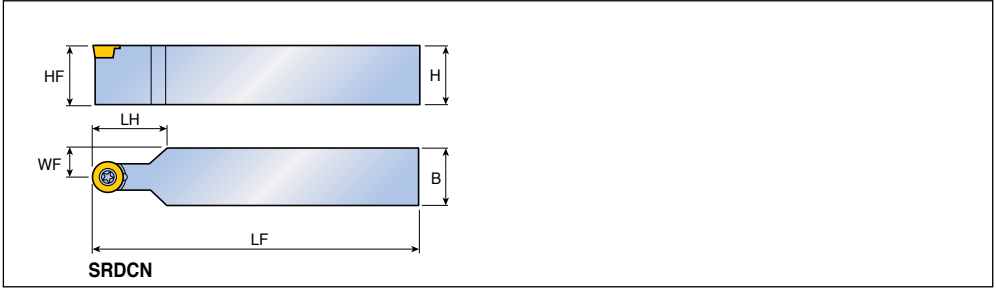

Approach angle	Designation	Dimension (mm)						Insert
		H	HF	B	LF	LH	WF	
45°	SRDCN 1616 H10	16	16	16	100	17.2	8	RC...T 10T3... A320
	2020 K10	20	20	20	125	22.5	10	
	2525 M10	25	25	25	150	27.5	12.5	
	2525 M12	25	25	25	150	27.5	12.5	
								RC...T 1204...

Spare parts



Designation	Screw	Wrench					
	...10	TS 40097I	T 15				
...12	SO 40050I	T 15					

SRGCR/L SRGCR/L-TB



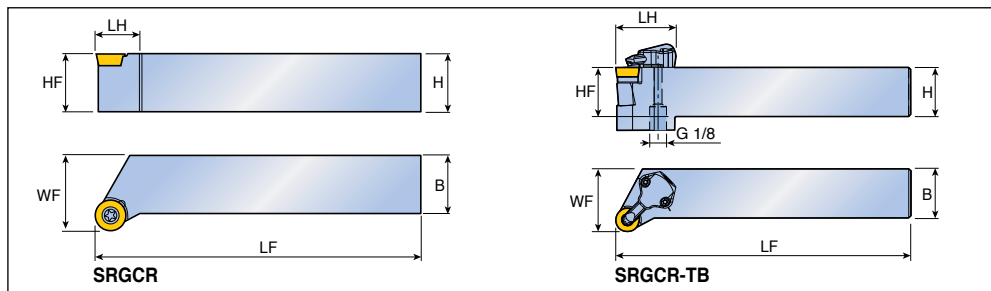

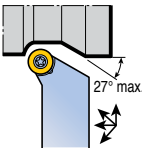

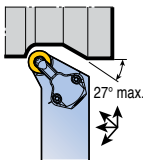

Screw type holders



Approach angle	Designation	Dimension (mm)						Insert
		H	HF	B	LF	LH	WF	
90° 	SRGCR/L 1616 H10	16	16	16	100	12.3	20	RC...T 10T3...  A320
	2020 K10	20	20	20	125	14	25	
	2525 M10	25	25	25	150	14	32	
90°  COOLBURST	SRGCR/L 2525 M12-TB	25	25	25	150	30	32	RC...T 1204...

Spare parts

Designation	Screw	Shim	Shim screw	Cooling unit	O-ring	Wrench	
							
...10	TS 400971	-	-	-	-	T 15	-
SRGCR/L...TB	TS 351101	SSR 32	TS 5035062S	CU-R-TB	ID 6.4x0.9	T 8, T 15	L-W 2, L-W 3.5

• Please refer to A164 page for COOL-BURST accessories

Screw type holders

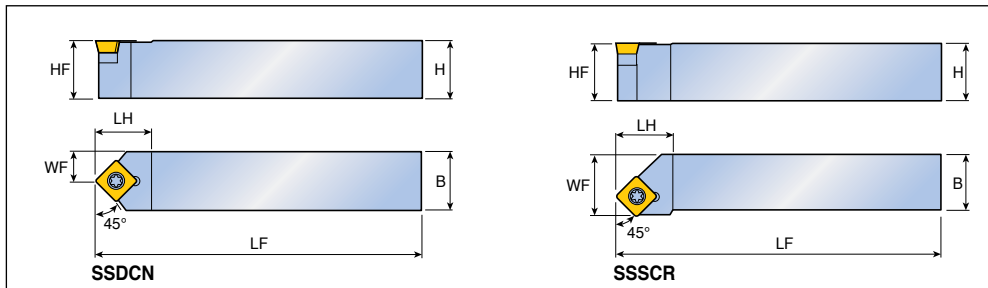

Approach angle	Designation	Dimension (mm)						Insert
		H	HF	B	LF	LH	WF	
45°	SSDCN 1212 F09	12	12	12	80	15.5	6	SC... 09T3... A321, A362
	1616 H09	16	16	16	100	15.5	8	
45°	SSSCR/L 1212 F09	12	12	12	80	15.5	14	SC... 09T3...
	1616 H09	16	16	16	100	15.5	17	
	2020 K12	20	20	20	125	24	22	SC... 1204... A321
	2525 M12	25	25	25	150	24	27	

Spare parts

Designation	Screw	Shim	Shim screw	Wrench				
...F09	SO 35080I	-	-	T 15				
...H09	SO 35124I	SSS 32	SO 50090S	T 15				
...12	SO 45130I	SSS 43N	SO 60105S	T 20				

Screw type holders

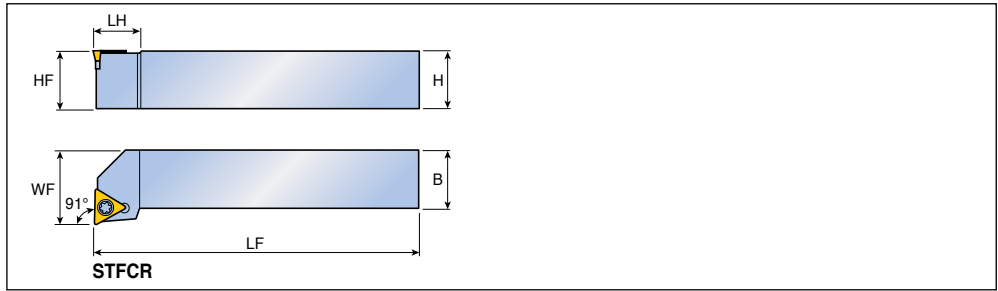

Approach angle	Designation	Dimension (mm)						Insert
		H	HF	B	LF	LH	WF	
91°	STFCR/L 1212 F11	12	12	12	80	14	16	TC... 1102...
	1616 H11	16	16	16	100	14	20	
	1616 H16	16	16	16	100	19	20	A363, A364
	2020 K16	20	20	20	125	19	25	
	2525 M16	25	25	25	150	20	32	

Spare parts

Designation	Screw	Shim	Shim screw	Wrench				
...11	SO 25065I	-	-	T 7				
...16	SO 35124I	SST 32	SO 50090S	T 15				

Screw type holders

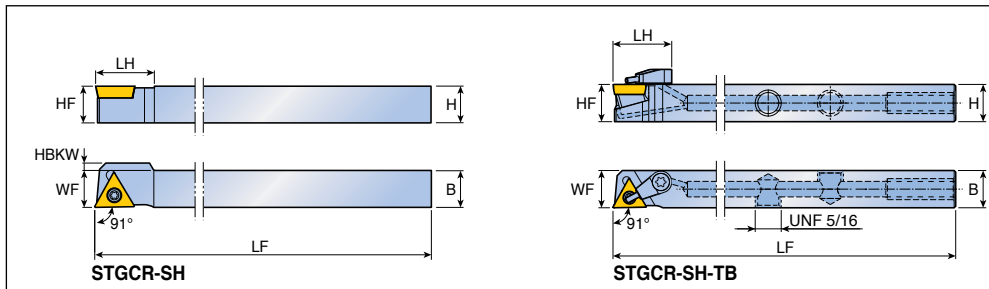

Approach angle	Designation	Dimension (mm)							Insert
		H	HF	B	LF	LH	WF	HBKW	
 91°	# STGCR/L 0808 E08-SH	8	8	8	70	11	8	2	TC...T 0802... TC... 1103... A324, A363, A364
	1010 F08-SH	10	10	10	80	11	10	-	
	1010 K11-SH	10	10	10	125	16	10	2	
	1212 K11-SH	12	12	12	125	16	12	-	
	1616 K11-SH	16	16	16	125	16	16	-	
 91°	# STGCR/L 1212 K11-SH-TB	12	12	12	125	20	12	-	
	1616 K11-SH-TB	16	16	16	125	20	16	-	

• # Marked: TOP-MINI holders

Spare parts

Designation	Screw	Cooling unit	Plug	Wrench			
...08-SH	TS 20043I/HG-P	-	-	T 6P	-		
...11-SH	SO 25065I	-	-	T 7	-		
STGCR/L-SH-TB	SO 25065I	S-CU-TB	PLG 5/16 UNF	T 7	L-W 5/32		

• Please refer to A165 page for COOL-BURST accessories

Screw type holders

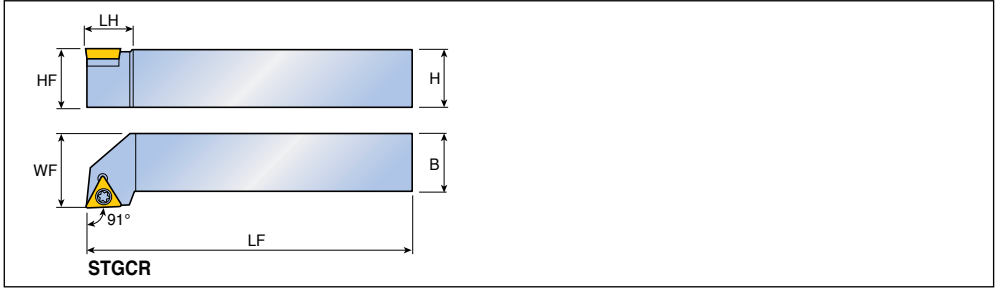

Approach angle	Designation	Dimension (mm)						Insert
		H	HF	B	LF	LH	WF	
	STGCR/L 0808 E08	8	8	8	70	10	10	TC...T 0802...
	1010 F08	10	10	10	80	10	12	A324, A325, A363, A364
	1010 E09	10	10	10	70	11	12	
	1212 F11	12	12	12	80	14.3	16	TC...T 0902...
	1616 H11	16	16	16	100	14.3	20	TC...T 1102...
	1616 H16	16	16	16	100	21	20	TC...T 16T3...
	2020 K16	20	20	20	125	21	25	
	2525 M16	25	25	25	150	21	32	

Spare parts

Designation	Screw	Shim	Shim screw	Wrench			
...09	SO 22050I	-	-	T 7			
...11	SO 25065I	-	-	T 7			
...16	SO 35124I	SST 32	SO 50090S	T 15			

Screw type holders

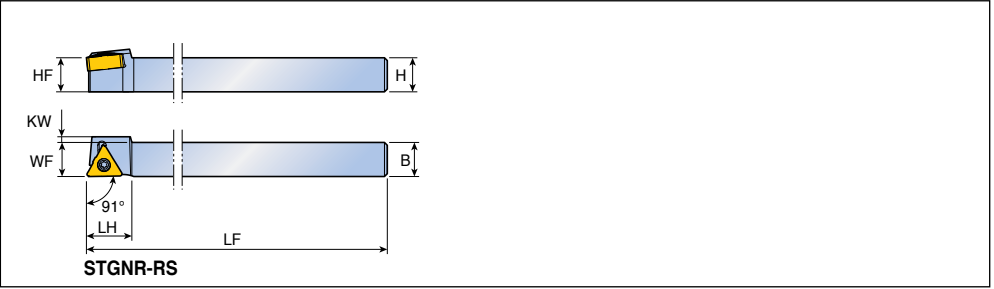



Approach angle	Designation	Dimension (mm)							Insert
		H	HF	B	LF	LH	WF	HBKW	
91°	STGNR 1212 K1304-RS	12	12	12	125	16	12	2	TN... 1304...
	1616 K1304-RS	16	16	16	125	16	16	-	A291-A296
	2020 K1304-RS	20	20	20	125	16	20	-	

Spare parts

Designation	Screw	Wrench					
	STGNR-RS	TS 300801/HG	T 9				

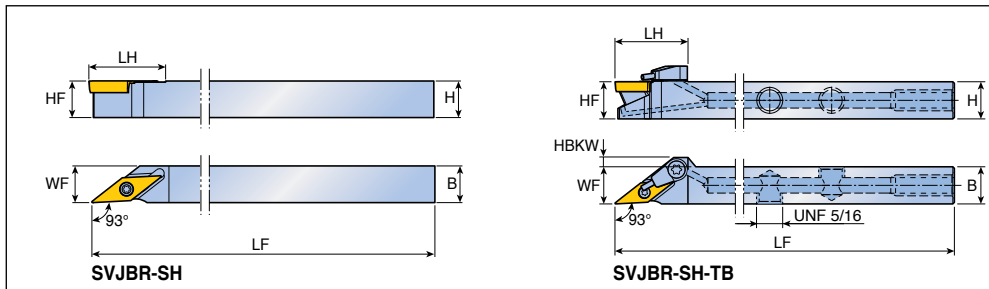

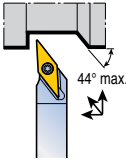

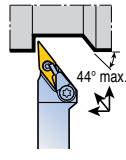
Screw type holders



Approach angle	Designation	Dimension (mm)							Insert	
		H	HF	B	LF	LH	WF	HBKW		
93° 	# SVJBR/L 1010 K11-SH	10	10	10	125	21	10	-	VB... 1103...  A330, A331, A365	
	1212 K11-SH	12	12	12	125	21	12	-		
	1616 K11-SH	16	16	16	125	21	16	-		
93°  COOL-BURST	# SVJBR/L 1212 K11-SH-TB	12	12	12	125	23.6	12	3		
	1616 K11-SH-TB	16	16	16	125	23.6	16	-		

• # Marked: TOP-MINI holders



Spare parts

Designation	Screw	Cooling unit	Plug	Wrench	
					
...11	SO 25065I	-	-	T 7	-
SVJBR/L-SH-TB	SO 25065I	S-CU-TB	PLG 5/16 UNF	T 7	L-W 5/32

• Please refer to A165 page for COOL-BURST accessories

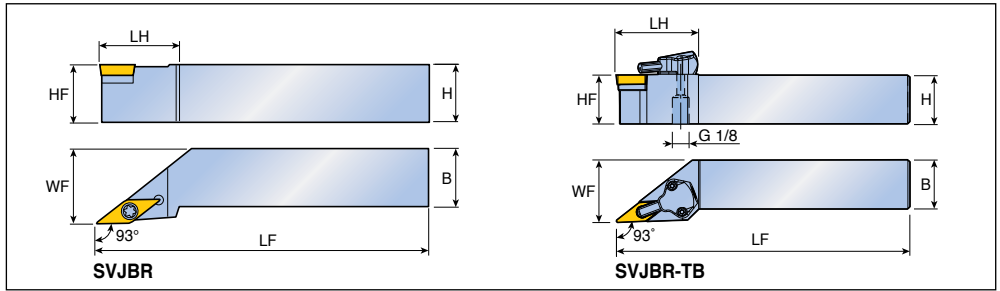
Screw type holders

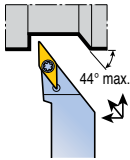

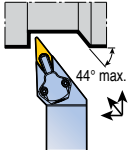
Approach angle	Designation	Dimension (mm)						Insert
		H	HF	B	LF	LH	WF	
93° 	SVJBR/L 2020 K16	20	20	20	125	35	25	VB... 1604...  A330, A331, A365
	2525 M16	25	25	25	150	35	32	
	3225 P16	32	32	25	170	35	32	
	3232 P16	32	32	32	170	35	40	
93°  COOLBURST	SVJBR/L 2525 M16-TB	25	25	25	150	42	32	

Spare parts

Designation	Screw	Shim	Shim screw	Cooling unit	O-ring	Wrench	
...16	SO 35124I	SSV 32	SO 50090S	-	-	T 15	-
SVJBR/L-TB	SO 35124I	SSV 32	TS 5035062S	CU-V-TB	ID 6.4x0.9	T 8, T 15	L-W 3.5

• Please refer to A164 page for COOL-BURST accessories

Screw type holders

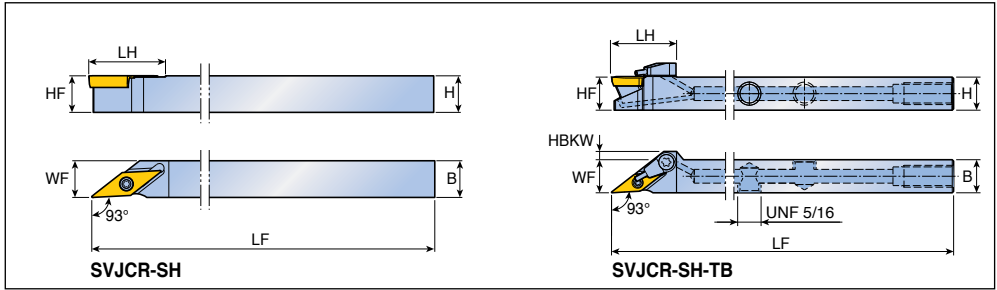

Approach angle	Designation	Dimension (mm)							Inserts
		H	HF	B	LF	LH	WF	HBKW	
<p>93°</p>	# SVJCR/L 1010 K11-SH	10	10	10	125	21	10	-	VC... 1103... A332, A333
	1212 K11-SH	12	12	12	125	21	12	-	
	1616 K11-SH	16	16	16	125	21	16	-	
	2020 K11-SH	20	20	20	125	21	20	-	
<p>93°</p>	# SVJCR/L 1212 K11-SH-TB	12	12	12	125	23.6	12	3	
	1616 K11-SH-TB	16	16	16	125	23.6	16	-	
	2020 K11-SH-TB	20	20	20	125	23.6	20	-	

• # Marked: TOP-MINI holders

Spare parts

Designation	Screw	Cooling unit	Plug	Wrench			
...11-SH	SO 25065I	-	-	T 7	-		
SVJCR/L-SH-TB	SO 25065I	S-CU-TB	PLG 5/16 UNF	T 7	L-W 5/32		

• Please refer to A165 page for COOL-BURST accessories

Screw type holders

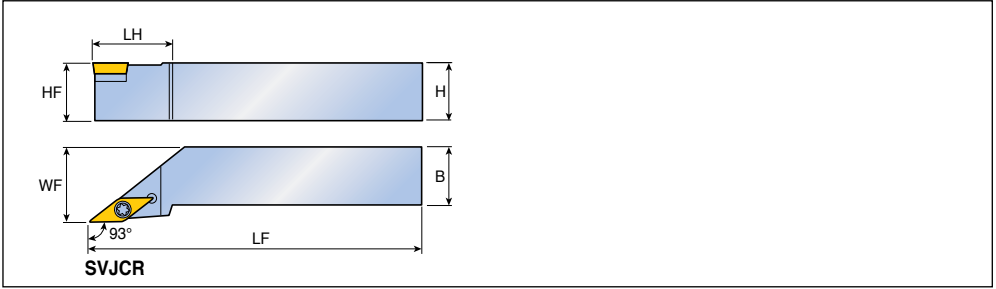

Approach angle	Designation	Dimension (mm)						Inserts
		H	HF	B	LF	LH	WF	
93°	SVJCR/L 2020 K16	20	20	20	125	35	25	VC... 1604... A332, A333
	2525 M16	25	25	25	150	35	32	
	3225 P16	32	32	25	170	35	32	
	3232 P16	32	32	32	170	47	40	

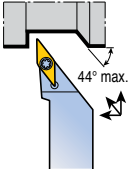



Spare parts



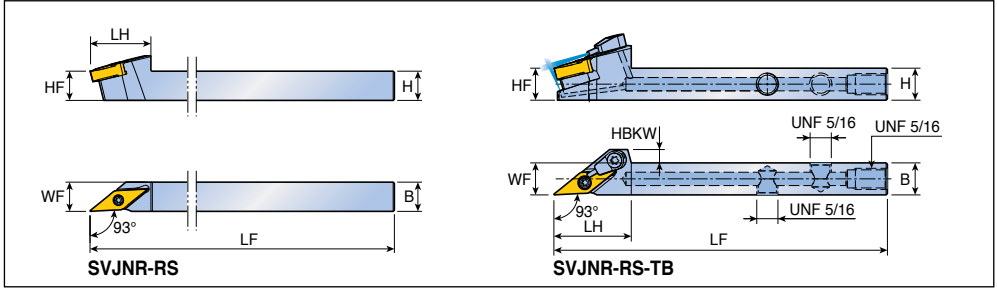

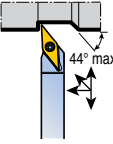
Designation	Screw	Shim	Shim screw	Wrench			
...16	SO 35124I	SSV 32	SO 50090S	T 10			

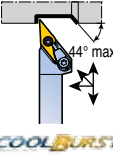
Screw type holders



Approach angle	Designation	Dimension (mm)							Insert
		H	HF	B	LF	LH	WF	HBKW	
93° 	SVJNR 1212 K1304-RS	12	12	12	125	25	12	-	VN...X 1304... YNMG 1304...  A297, A299, A305
	1616 K1304-RS	16	16	16	125	25	16	-	
	2020 K1304-RS	20	20	20	125	25	20	-	
93° 	SVJNR 1212 K1305-RS-TB	12	12	12	125	29	12	5	
	1616 K1305-RS-TB	16	16	16	125	29	16	1	

Spare parts

Designation	Screw	Cooling unit	Plug	Wrench			
							
SVJNR-RS	TS 300801/HG	-	-	T 9	-		
SVJNR-RS-TB	TS 300801/HG	S-CU-TB	PLG 5/16 UNF	T 9	L-W 5/32		

• Please refer to A165 page for COOL-BURST accessories

Screw type holders

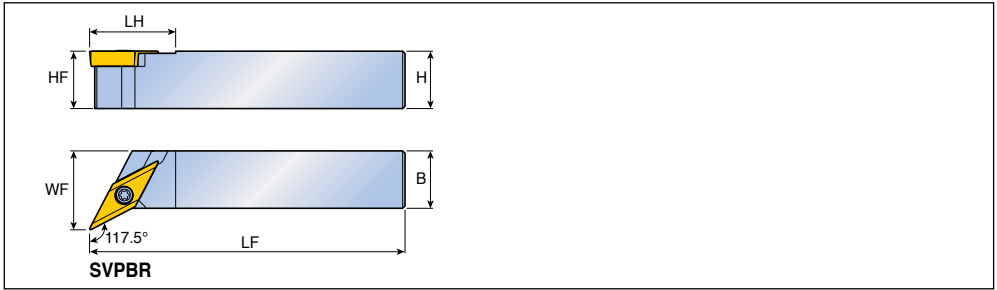



Approach angle	Designation	Dimension (mm)						Insert
		H	HF	B	LF	LH	WF	
117.5 	SVPBR/L 1010 E11	10	10	10	70	18	14.5	VB... 1103... A330, A331, A365
	1212 F11	12	12	12	80	18	16.5	
	1616 F11	16	16	16	80	18	20.5	
	2020 K11	20	20	20	125	18	25	VB... 1604...
	2525 M11	25	25	25	150	18	32	
	2020 K16	20	20	20	125	25	25	
	2525 M16	25	25	25	150	25	32	

Spare parts

Designation	Screw	Shim	Shim screw	Wrench			
...11	SO 25065I	-	-	T 7	-		
...16	SO 35124I	SSV 32	SO 50090S	T 15	L-W 3.5		

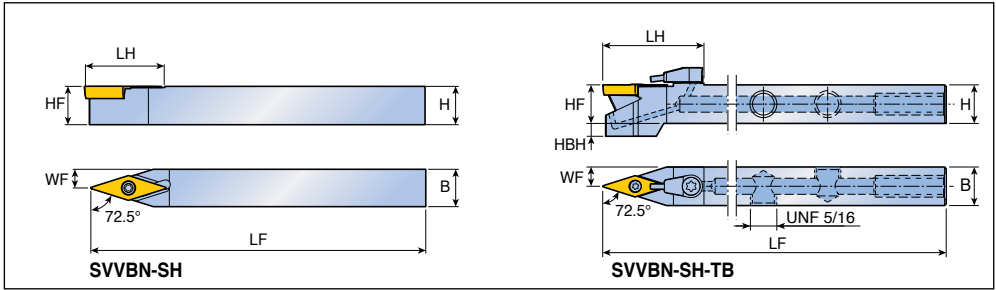

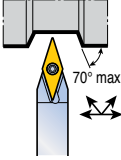

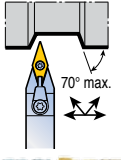
Screw type holders



Approach angle	Designation	Dimension (mm)							Insert
		H	HF	HBH	B	LF	LH	WF	
72.5° 	# SVVBN 1010 K11-SH	10	10	-	10	125	22	5	VB... 1103...  A330, A331, A365
	1212 K11-SH	12	12	-	12	125	22	6	
	1616 K11-SH	16	16	-	16	125	22	8	
72.5°  COOLBURST	# SVVBN 1212 K11-SH-TB	12	12	2	12	125	31.5	6	
	1616 K11-SH-TB	16	16	-	16	125	31.5	8	

• # Marked: TOP-MINI holders

Spare parts

Designation	Screw	Cooling unit	Plug	Wrench				
								
...11	SO 25065I	-	-	T 7	-			
SVVBN-SH-TB	SO 25065I	S-CU-TB	PLG 5/16 UNF	T 7	L-W 5/32			

• Please refer to A165 page for COOL-BURST accessories

Screw type holders

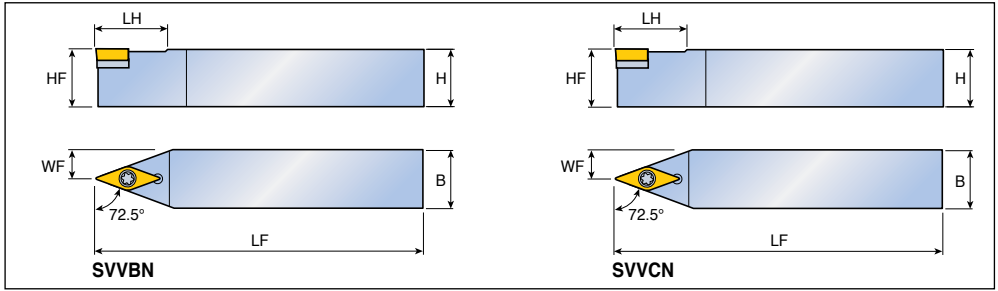

Approach angle	Designation	Dimension (mm)						Insert
		H	HF	B	LF	LH	WF	
72.5° 	SVVBN 2020 K16	20	20	20	125	31.5	10.0	VB... 1604... A330, A331, A365
	2525 M16	25	25	25	150	31.5	12.5	
	3225 P16	32	32	25	170	31.5	12.5	
72.5° 	SVVCN 2020 K16	20	20	20	125	31.5	10.0	VC...T 1604...
	2525 M16	25	25	25	150	31.5	12.5	
	3225 P16	32	32	25	170	31.5	12.5	
	3232 P16	32	32	32	170	32	16.0	

Spare parts

Designation	Screw	Shim	Shim screw	Wrench			
...16	SO 35124I	SSV 32	SO 50090S	T 15			

Screw type holders

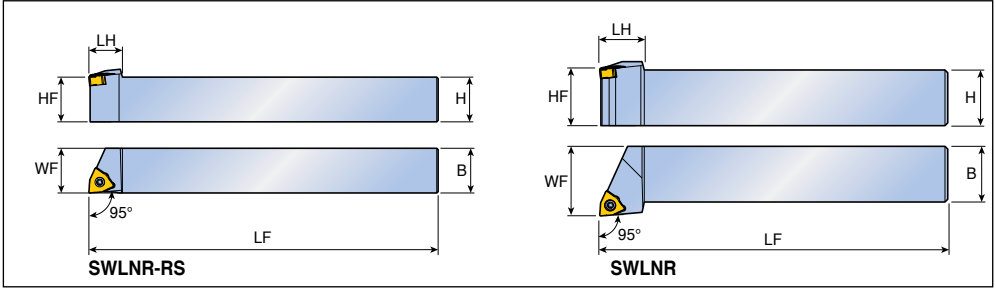

Approach angle	Designation	Dimension (mm)						Insert
		H	HF	B	LF	LH	WF	
95°	SWLNR/L 1212 K0403-RS	12	12	12	125	12	12	WNMX 0403... A303
	1616 K0403-RS	16	16	16	125	12	16	
95°	SWLNR/L 1616 H0403	16	16	16	100	16	20	
	2020 K0403	20	20	20	125	16	25	

Spare parts

Designation	Screw	Wrench					
	...0403...	TS 25D060/HG-P	T 7P				

Screw type back turning holders

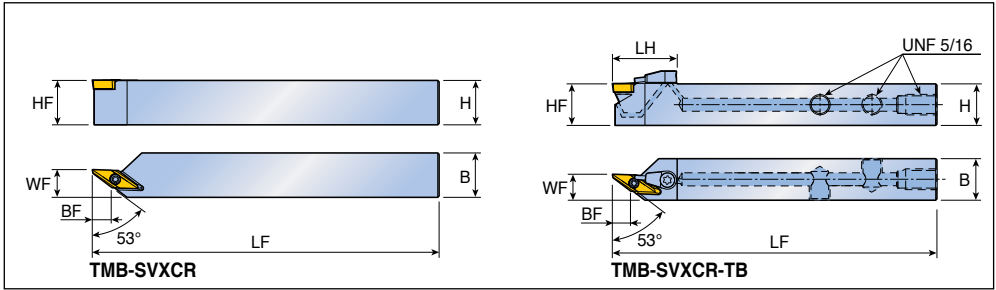

Approach angle	Designation	Dimension (mm)							Insert
		H	HF	B	LF	LH	WF	BF	
53°	# TMB-SVXCR 1212 K11	12	12	12	125	-	10	7.2	BTVC 1103... A308
	1616 K11	16	16	16	125	-	10	7.2	
53°	# TMB-SVXCR 1212 K11-TB	12	12	12	125	25	10	7.2	
	1616 K11-TB	16	16	16	125	25	10	7.2	

• # Marked: TOP-MINI holders

Spare parts

Designation	Screw	Cooling unit	Plug	Wrench	
TMB-SVXCR	SO 25065I	-	-	T 7	-
TMB-SVXCR-TB	SO 25065I	S-CU-TB	PLG 5/16 UNF	T 7	L-W 5/32

• Please refer to A165 page for COOL-BURST accessories

Sleeve holders

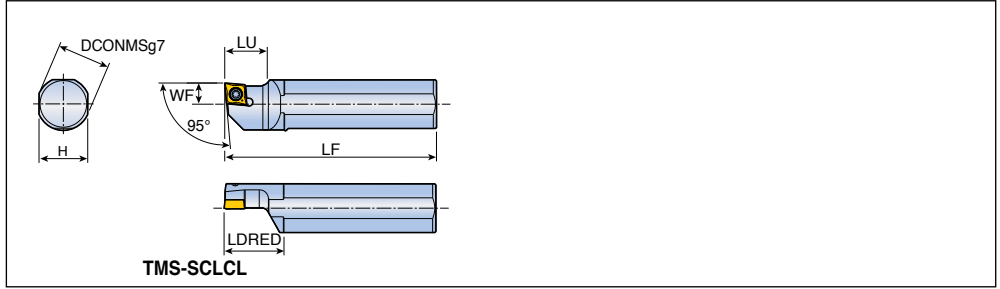

Approach angle	Designation	Dimension (mm)						Insert
		DCONMS	H	LF	LU	LDRED	WF	
95°	# TMS-19.05H SCLCL 09	19.05	17	100	20	28	10	CC... 09T3...
	20H SCLCL 09	20	18	100	20	28	10	 A309-A312, A360
	22H SCLCL 09	22	20	100	20	28	10	
	25H SCLCL 09	25	23	100	20	28	10	

• # Marked: TOP-MINI holders

Spare parts

Designation	Screw	Wrench				
TMS-SCLCL	SO 35080I	T 15				

Sleeve holders

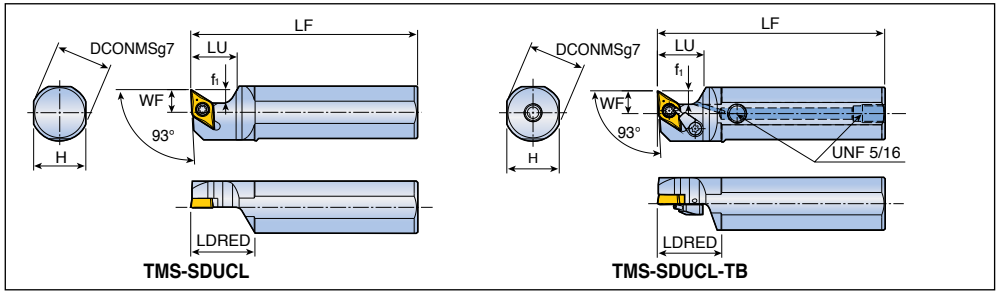

Approach angle	Designation	Dimension (mm)							Insert
		DCONMS	H	LF	f ₁	LU	LDRED	WF	
 93°	# TMS- 16X SDUCL 11	16	15	85	6	20	28	10	DC... 11T3... A314-A317, A361
	19.05H SDUCL 11	19.05	17	100	6	20	28	10	
	20H SDUCL 11	20	18	100	6	20	28	10	
	22H SDUCL 11	22	20	100	6	20	28	10	
	25H SDUCL 11	25	23	100	6	20	28	10	
 93°	# TMS- 16X SDUCR 11- TB	16	15	85	6	20	28	10	
	19.05H SDUCL 11-TB	19.05	17	100	6	20	28	10	
	20H SDUCL 11-TB	20	18	100	6	20	28	10	
	22H SDUCL 11-TB	22	20	100	6	20	28	10	
	25H SDUCL 11-TB	25	23	100	6	20	28	10	

• # Marked: TOP-MINI holders

Spare parts

Designation	Screw	Cooling unit	Plug	Wrench	
TMS-SDUCL	SO 35080I	-	-	T 15	-
TMS-SDUCL-TB	SO 35080I	S-CU-TB	PLG 5/16 UNF	T 15	L-W 5/32

• Please refer to A165 page for COOL-BURST accessories

Sleeve holders

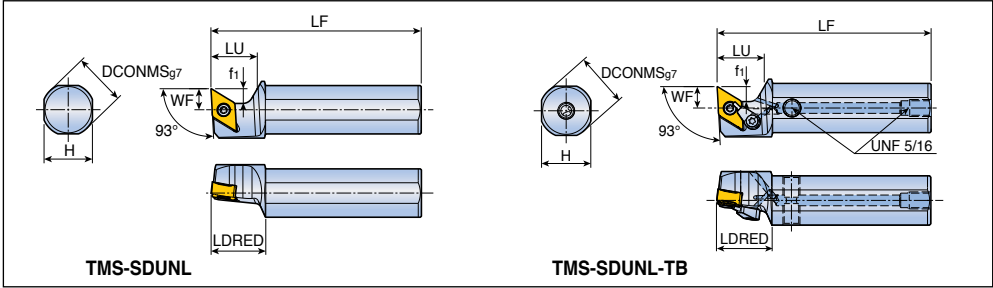

Approach angle	Designation	Dimension (mm)							Insert
		DCONMS	H	LF	f1	LU	LDRED	WF	
 93°	TMS- 16X SDUNL 1305	16	15	85	7	22	26	10	DN...1305... A276-A281
	19.05H SDUNL 1305	19.05	17	100	7	22	26	10	
	20H SDUNL 1305	20	18	100	7	22	26	10	
	22H SDUNL 1305	22	20	100	7	22	26	10	
	25H SDUNL 1305	25	23	100	7	22	26	10	
 93°	TMS- 25H SDUNL 1305-TB	25	23	100	7	22	26	10	

Spare parts

Designation	Screw	Cooling unit	Plug	Wrench	
TMS-SDUNL	TS 40G110I	-	-	T 15	-
TMS-SDUNL-TB	TS 40G110I	S-CU-TB	PLG 5/16 UNF	T 15	L-W 5/32

• Please refer to A165 page for COOL-BURST accessories

Sleeve holders

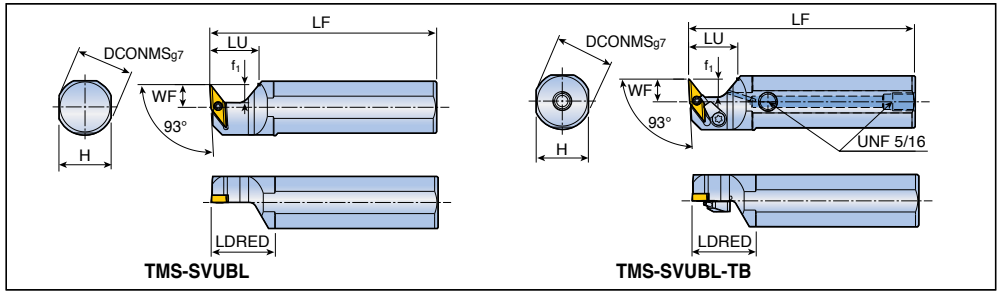

Approach angle	Designation	Dimension (mm)								Insert
		DCONMS	H	LF	f ₁	LU	LDRED	WF		
 93°	# TMS- 19.05H SVUBL 11	19.05	17	100	8	21	25	10	VB... 1103... A330, A331, A365	
	20H SVUBL 11	20	18	100	8	21	25	10		
	22H SVUBL 11	22	20	100	8	21	25	10		
	25H SVUBL 11	25	23	100	8	21	28	10		
 93°	# TMS- 16X SVUBR 11-TB	16	15	85	8	21	25	10	COOLBURST	
	19.05H SVUBL 11-TB	19.05	17	100	8	21	25	10		
	20H SVUBL 11-TB	20	18	100	8	21	25	10		
	22H SVUBL 11-TB	22	20	100	8	21	25	10		
	25H SVUBL 11-TB	25	23	100	8	21	28	10		

• # Marked: TOP-MINI holders

Spare parts

Designation	Screw	Cooling unit	Plug	Wrench	
TMS-SVUBL	SO 25065I	-	-	T 7	-
TMS-SVUBR/L-TB	SO 25065I	S-CU-TB	PLG 5/16 UNF	T 7	L-W 5/32

• Please refer to A165 page for COOL-BURST accessories

Y-axis holders

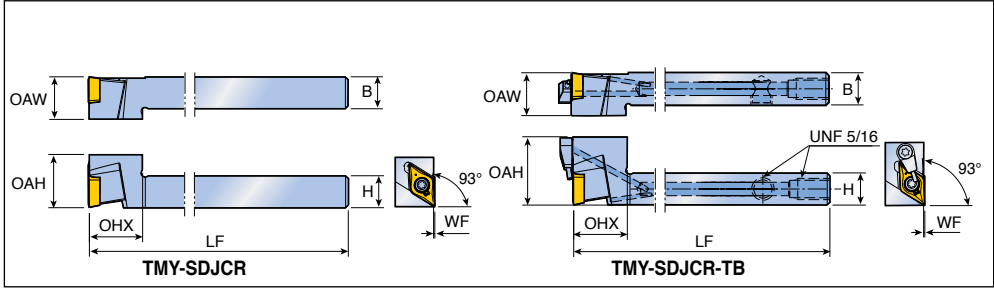

Approach angle	Designation	Dimension (mm)							Insert
		H	B	LF	OHX	OAH	OAW	WF	
93° 27° max. 	# TMY- SDJCR 1212 K11	12	12	125	21	20	16	0	DC... 11T3... A314-A317, A361
	SDJCR 1616 K11	16	16	125	21	20	16	0	
93° 27° max. COOLBURST	# TMY- SDJCR 1212 K11-TB	12	12	125	21	25.5	16	0	
	SDJCR 1616 K11-TB	16	16	125	21	25.5	16	0	

• # Marked: TOP-MINI holders

Spare parts

Designation	Screw	Cooling unit	Plug	Wrench	
TMY-SDJCR	SO 35080I	-	-	T 15	-
TMY-SDJCR-TB	SO 35080I	S-CU-TB	PLG 5/16 UNF	T 15	L-W 5/32

• Please refer to A165 page for COOL-BURST accessories

Y-axis holders

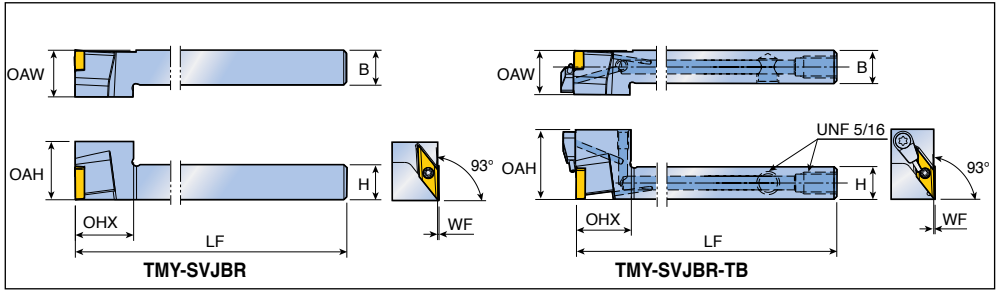

Approach angle	Designation	Dimension (mm)							Insert
		H	B	LF	OHX	OAH	OAW	WF	
93° 	# TMY-SVJBR 1212 K11	12	12	125	20	20	16	0	VB... 1103... A330, A331, A365
	SVJBR 1616 K11	16	16	125	20	20	16	0	
93° 	# TMY-SVJBR 1212 K11-TB	12	12	125	20	25.5	16	0	VB... 1103... A330, A331, A365
	SVJBR 1616 K11-TB	16	16	125	20	25.5	16	0	

• # Marked: TOP-MINI holders

Spare parts

Designation	Screw	Cooling unit	Plug	Wrench	
TMY-SVJBR	SO 25065I	-	-	T 7	-
TMY-SVJBR-TB	SO 25065I	S-CU-TB	PLG 5/16 UNF	T 7	L-W 5/32

• Please refer to A165 page for COOL-BURST accessories

Shift holders

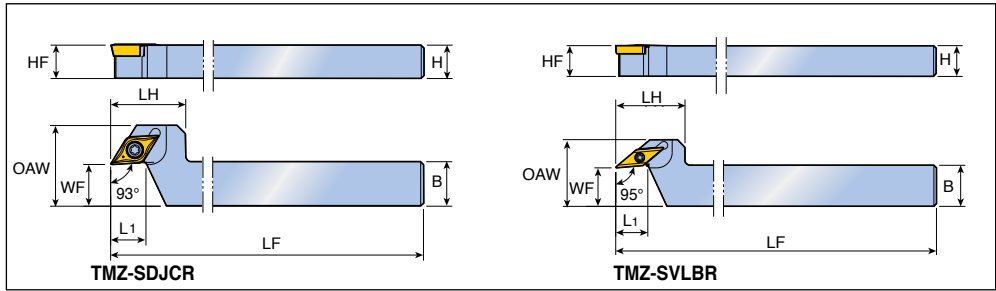

Approach angle	Designation	Dimension (mm)								Insert
		H	HF	B	LF	L1	OAW	LH	WF	
93° 	# TMZ- SDJCR 1216 K11-F15	12	12	16	125	12.5	29	27	15	DC... 11T3... A314-A317, A361
	SDJCR 1620 K11-F15	16	16	20	125	16.3	29	30	15	
95° 	# TMZ- SVLBR 1216 K11-F15	12	12	16	125	12.3	26	27	15	VB... 1103... A330, A331, A365
	SVLBR 1620 K11-F15	16	16	20	125	16.2	26	30	15	

• # Marked: TOP-MINI holders

Spare parts

Designation	Screw	Wrench				
TMZ-SDJCR	SO 35080I	T 15				
TMZ-SVLBR	SO 25065I	T 7				

T-holders

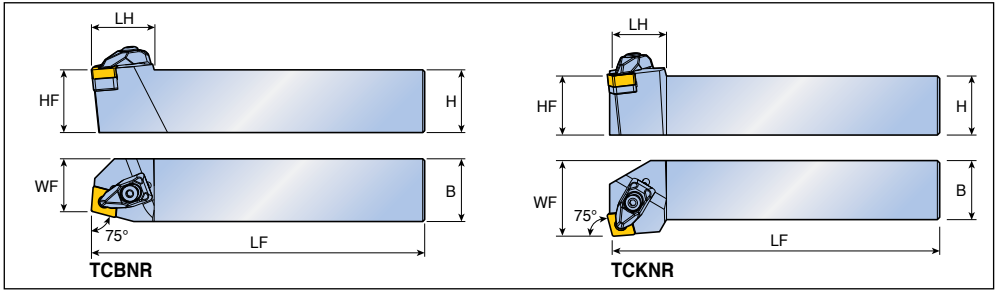

Approach angle	Designation	Dimension (mm)						Insert
		H	HF	B	LF	LH	WF	
75° 	TCBNR/L 2525 M12	25	25	25	150	32	22.5	CN... 1204...
	3232 P19	32	32	32	170	42	27	CN... 1906... A266, A268-A273
75° 	TCKNR/L 2525 M12	25	25	25	150	25	32	CN... 1204...

Spare parts

Designation	Clamp	Clamp screw	Spring	Shim	Shim screw		Wrench	
...12	DLM 4	DLS 4	DSP 4	TSC 44	SO 40050I	-	L-W 3	T 15
...19	DLM 6	DLS 5	DSP 5	LSC 63	-	SO 80180I	L-W 4	-

T-holders

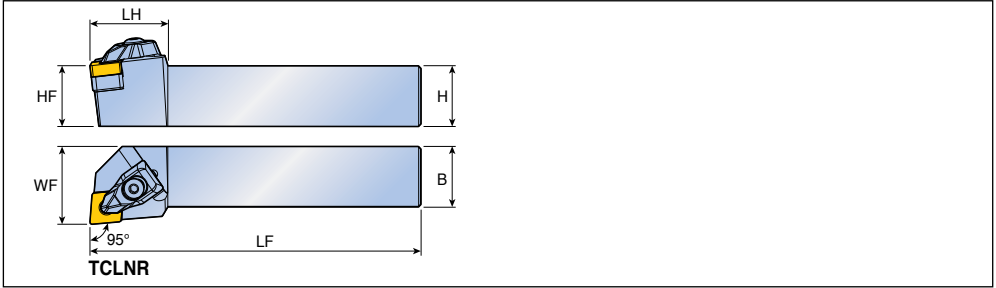

Approach angle	Designation	Dimension (mm)						Insert
		H	HF	B	LF	LH	WF	
	TCLNR/L 2020 H0904	20	20	20	100	25	25	CN... 0904...
	2020 K0904	20	20	20	125	25	25	
	2525 M0904	25	25	25	150	25	32	
	TCLNR/L 2020 K12	20	20	20	125	32	25	CN... 1204...
	2525 M12	25	25	25	150	32	32	
	3225 P12	32	32	25	170	32	32	
	3232 P12	32	32	32	170	32	40	
	2525 M16	25	25	25	150	36	32	CN... 1606...
	3232 P16	32	32	32	170	36	40	
	3232 P19	32	32	32	170	42	40	CN... 1906...
4040 S19	40	40	40	250	42	50		

A266,
 A268-A273

Spare parts

Designation	Clamp	Clamp screw	Spring	Shim	Shim screw		Wrench	
...0904	DLM 3-NX	DLS 3	DSP 3	LSC 32A	SO 40085I	-	L-W 2.5	T 15
...12	DLM 4	DLS 4	DSP 4	TSC 44	SO 40050I	-	L-W 3	T 15
...16	DLM 5	DLS 5	DSP 5	TSC 54	SO 50090I	-	L-W 4	T 20
...19	DLM 6	DLS 5	DSP 5	LSC 63	-	SO 80180I	L-W 4	-

T-holders

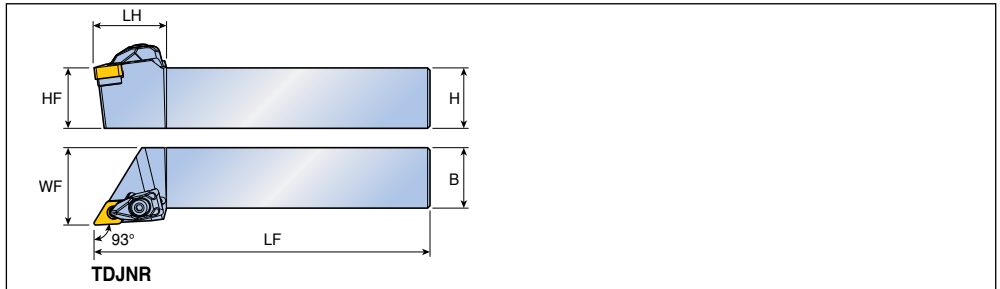

Approach angle	Designation	Dimension (mm)							Insert
		H	HF	B	LF	LH	WF		
 27° max.	TDJNR/L 2020 K11	20	20	20	125	30	25	DN... 1104...	
	2525 M11	25	25	25	150	30	32		 A276-A281
	TDJNR/L 2020 H1305	20	20	20	100	33	25	DN... 1305...	
	2020 K1305	20	20	20	125	33	25		
	2525 M1305	25	25	25	150	36	32		
	TDJNR/L 2020 K15	20	20	20	125	39	25	DN... 1506...	
	2525 M15	25	25	25	150	39	32	DN... 1504...	
	3232 P15	32	32	32	170	39	40		
	2020 K1504	20	20	20	125	39	25		
	2525 M1504	25	25	25	150	39	32		

Spare parts

Designation	Clamp	Clamp screw	Spring	Shim		Shim screw	Wrench	
...11	DLM 3	DLS 3	DSP 3	LSD 32	-	SO 40085I	L-W 2.5	T 15
...1305	DLM 3.5-NX	DLS 4	DSP 4	LSD 3.52	-	SO 50090I	L-W 3	T 20
...15	DLM 4	DLS 4	DSP 4	-	TSD 43	SO 40050I	L-W 3	T 15
...1504	DLM 4	DLS 4	DSP 4	-	TSD 44	SO 40050I	L-W 3	T 15

T-holders

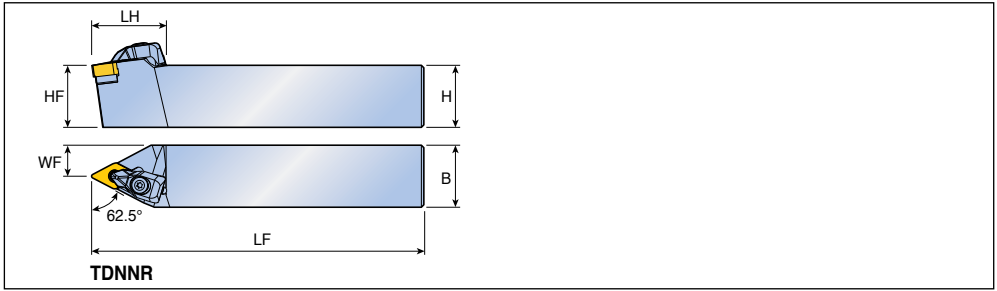

Approach angle	Designation	Dimension (mm)						Insert
		H	HF	B	LF	LH	WF	
62.5°	TDNNR/L 2525 M11	25	25	25	150	30	12.5	DN... 1104...
	TDNNR/L 2020 K1305	20	20	20	125	34	10	DN... 1305...
	TDNNR/L 2525 M1305	25	25	25	150	34	12.5	<i>RHINO TURN</i>

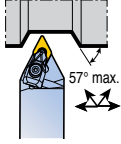



A276-A281

Spare parts

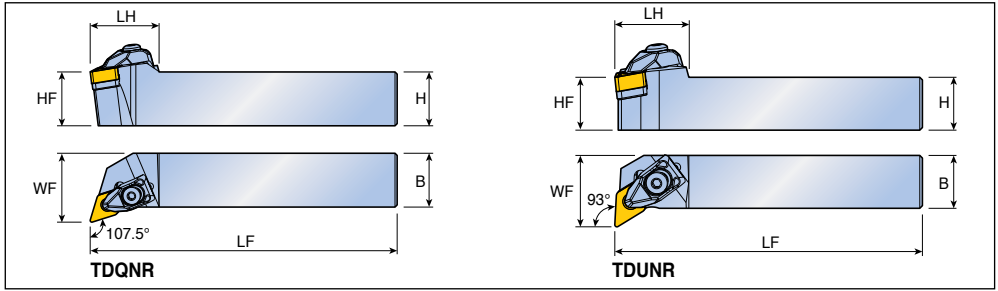

Designation	Clamp	Clamp screw	Spring	Shim	Shim screw	Wrench	
...11	DLM 3	DLS 3	DSP 3	LSD 32	SO 400851	L-W 2.5	T 15
...1305	DLM 3.5-NX	DLS 4	DSP 4	LSD 3.52	SO 500901	L-W 3	T 20

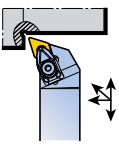
T-holders

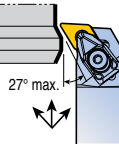

Approach angle	Designation	Dimension (mm)						Insert
		H	HF	B	LF	LH	WF	
107.5° 	TDQNR/L 2020 K1305	20	20	20	125	32	25	DN... 1305...  A276-A281
	2525 M1305	25	25	25	150	32	32	
93° 	TDUNR/L 2020 K1305	20	20	20	125	28	27	
	2525 M1305	25	25	25	150	28	32	

Spare parts

Designation	Clamp	Clamp screw	Spring	Shim	Shim screw	Wrench	
...1305	 DLM 3.5-NX	 DLS 4	 DSP 4	 LSD 3.52	 SO 50090I	 L-W 3	 T 20

T-holders

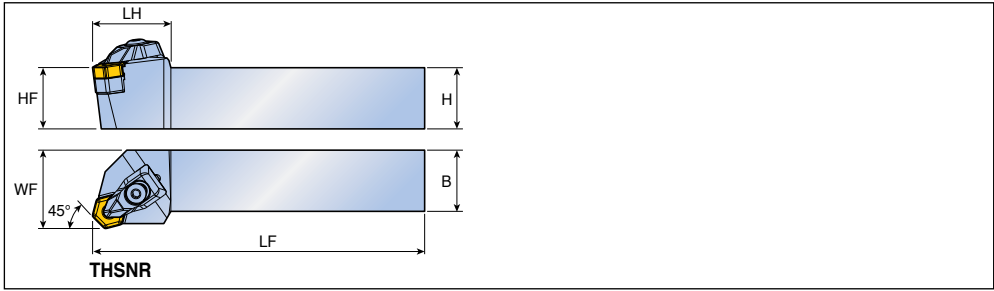

Approach angle	Designation	Dimension (mm)						Insert
		H	HF	B	LF	LH	WF	
45° 	THSNR/L 2525 M05	25	25	25	150	32	32	HN... 0504... HN... 1006... A282
	3232 P05	32	32	32	170	32	40	
	2525 M10	25	25	25	150	42	32	
	3232 P10	32	32	32	170	42	40	

Spare parts

Designation	Clamp	Clamp screw	Spring	Shim	Shim screw	Wrench	
...05							
...10	DLM 4	DLS 4	DSP 4	TSH 44	SO 40050I	L-W 3	T 15
	DLM 6	DLS 5	DSP 5	TSH 64	SO 50090I	L-W 4	T 20

T-holders

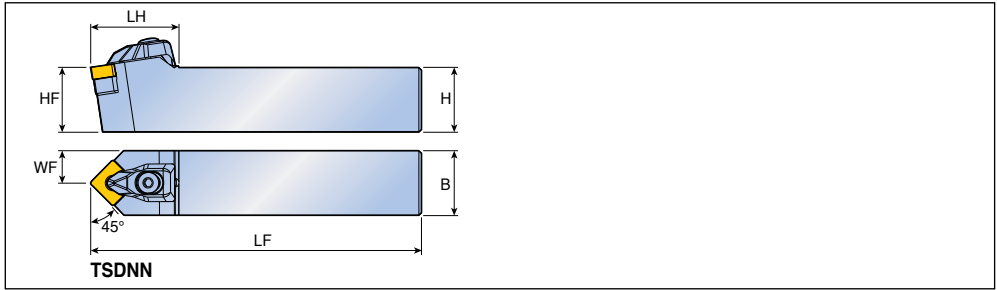

Approach angle	Designation	Dimension (mm)						Insert
		H	HF	B	LF	LH	WF	
45°	TSDNN 2020 K0904	20	20	20	125	28	10	SN... 0904...
	2525 M0904	25	25	25	150	28	12.5	A284-A290,
	TSDNN 2525 M12	25	25	25	150	34	12.5	SN... 1204... A346, A347,
	3232 P19	32	32	32	170	44	16	SN... 1906... A356

Spare parts

Designation	Clamp	Clamp screw	Spring	Shim	Shim screw		Wrench	
...0904	DLM 3-NX	DLS 3	DSP 3	LSS 32A	SO 40085I	-	L-W 2.5	T 15
...12	DLM 4	DLS 4	DSP 4	TSS 44	SO 40050I	-	L-W 3	T 15
...19	DLM 6	DLS 5	DSP 5	LSS 63	-	SO 80180I	L-W 4	-

T-holders

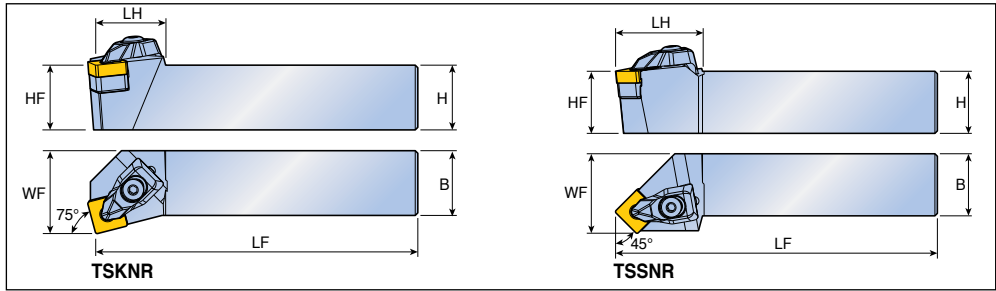

Approach angle	Designation	Dimension (mm)						Insert	
		H	HF	B	LF	LH	WF		
75° 	TSKNR/L 2525 M12	25	25	25	150	27	32	SN... 1204... A284-A290, A346, A347, A356	
45° 	TSSNR/L 2020 K0904	20	20	20	125	23	25	SN... 0904...	
	2525 M0904	25	25	25	150	23	32	RHINO TURN	
	TSSNR/L 2525 M12	25	25	25	150	35	32	SN... 1204...	

Spare parts

Designation	Clamp	Clamp screw	Spring	Shim	Shim screw	Wrench	
...0904	DLM 3-NX	DLS 3	DSP 3	LSS 32A	SO 40085I	L-W 2.5	T 15
...12	DLM 4	DLS 4	DSP 4	TSS 44	SO 40050I	L-W 3	T 15

T-holders

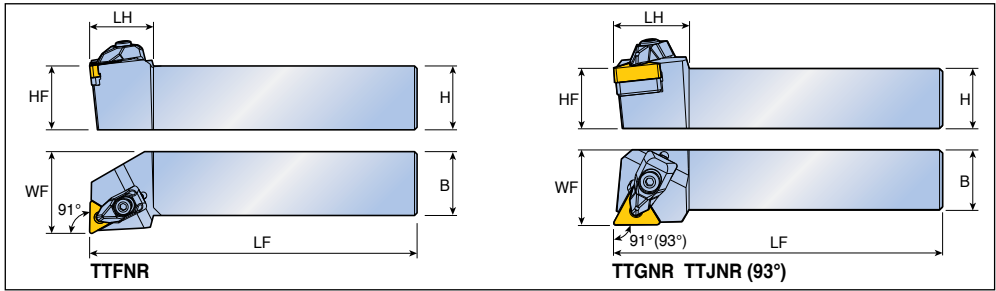

Approach angle	Designation	Dimension (mm)						Insert
		H	HF	B	LF	LH	WF	
91° 	TTFNR/L 2020 K1304	20	20	20	125	25	25	TN... 1304... A291-A296
	2525 M1304	25	25	25	150	25	32	
91°(93°) 	TTGNR/L 2020 H1304	20	20	20	100	25	25	TN... 1304...
	2020 K1304	20	20	20	125	25	25	
	2525 M1304	25	25	25	150	25	32	
	TTJNR/L 2525 M1304	25	25	25	150	25	32	TN... 1604... A291-A296, A349, A357
	TTGNR/L 2525 M16	25	25	25	150	25	32	
	TTJNR/L 2020 K16	20	20	20	125	25	25	
	2525 M16	25	25	25	150	25	32	

Spare parts

Designation	Clamp	Clamp screw	Spring	Shim	Shim screw	Wrench	
...1304	DLM 2.5-NX	DLS 3	DSP 3	LST 2.52	SO 400851	L-W 2.5	T 15
...16	DLM 3	DLS 3	DSP 3	TST 33	SO 350801	L-W 2.5	T 15

T-holders

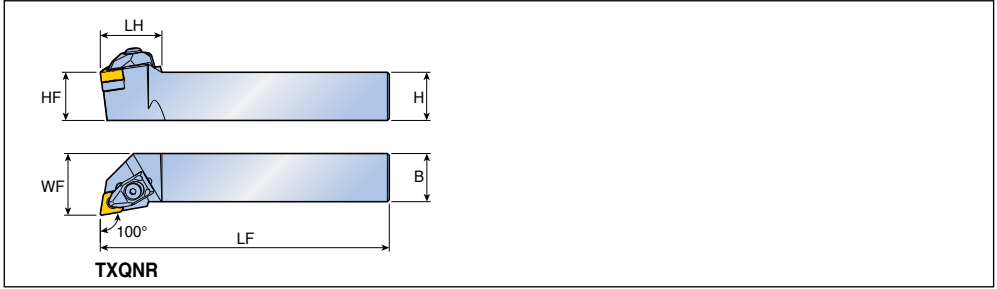

Approach angle	Designation	Dimension (mm)						Insert
		H	HF	B	LF	LH	WF	
	TXQNR/L 2020 K0904	20	20	20	125	25	25	XNMG 0904...
	2525 M0904	25	25	25	150	25	32	<i>RHINOXTURN</i>
	2020 K1105	20	20	20	125	30	25	XNMG 1105...
	2525 M1105	25	25	25	150	32	32	<i>RHINOXTURN</i>

Spare parts

Designation	Clamp	Clamp screw	Spring	Shim	Shim screw	Wrench	
...0904	DLM 2.5-NX	DLS 3	DSP 3	TSX 2.73	SO 40085I	L-W 2.5	T 15
...1105	DLM 3.5-NX	DLS 4	DSP 4	TSX 3.53	SO 50090I	L-W 3	T 20

TZQNR/L TZQNR-TB

T-holders for ZNMV insert

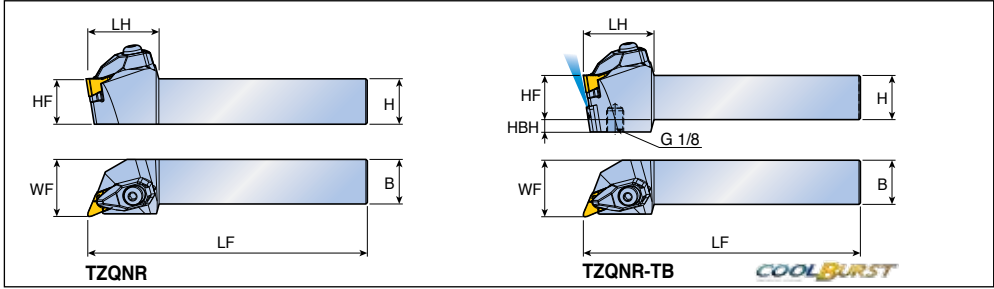

Approach angle	Designation	Dimension (mm)							Insert	
		H	HF	B	LF	LH	WF	HBH		
ZNMV 23°(BWT) 95°(FWT)	TZQNR/L 2525 M1410	25	25	25	150	40	32	-	ZNMV 1410... A307	
	3232 P1410	32	32	32	170	40	40	-		
	TZQNR/L 2525 M1410-TB	25	25	25	150	40	32	7		
	3232 P1410-TB	32	32	32	170	40	40	-		
ZNMV Y-BF 28°(BWT) 118°(FWT)										

- BWT: Backward turning
- FWT: Forward turning

Spare parts

Designation	Clamp	Clamp screw	Spring	Shim	Shim screw	Wrench	
...1410	DLM 3.3Z-NV	DLS 5	DSP 5	TSZ 140310	TS 350831/HG	L-W 4	T 10
...1410-TB	DLM 3.3Z-NV	DLS 5	DSP 5	TSZ 140310	TS 350831/HG	L-W 4	T 10

• Please refer to A164 page for COOL-BURST accessories

T-holders for ZNMV Y-BF insert

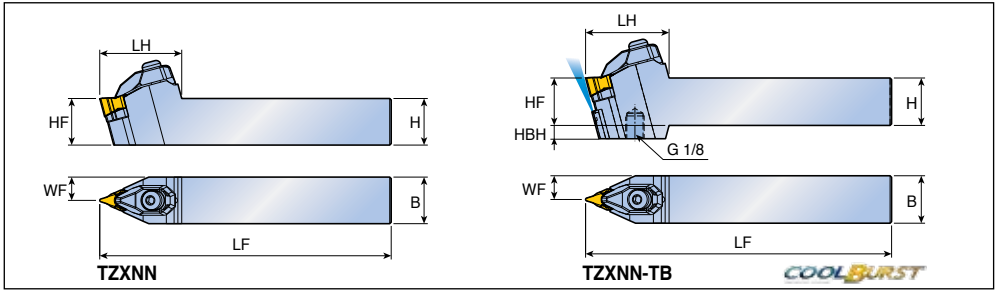

Approach angle	Designation	Dimension (mm)							Insert	
		H	HF	B	LF	LH	WF	HBH		
	TZXNN 2525 M1410	25	25	25	150	44	12.5	-	ZNMV 1410...Y-BF 	
	3232 P1410	32	32	32	170	44	16	-		
	TZXNN 2525 M1410-TB	25	25	25	150	44	12.5	7		
	3232 P1410-TB	32	32	32	170	44	16	-		





Spare parts

Designation	Clamp	Clamp screw	Spring	Shim	Shim screw	Wrench	
...1410	DLM 3.3Z-NV	DLS 5	DSP 5	TSZ 140310	TS 350831/HG	L-W 4	T 10
...1410-TB	DLM 3.3Z-NV	DLS 5	DSP 5	TSZ 140310	TS 350831/HG	L-W 4	T 10

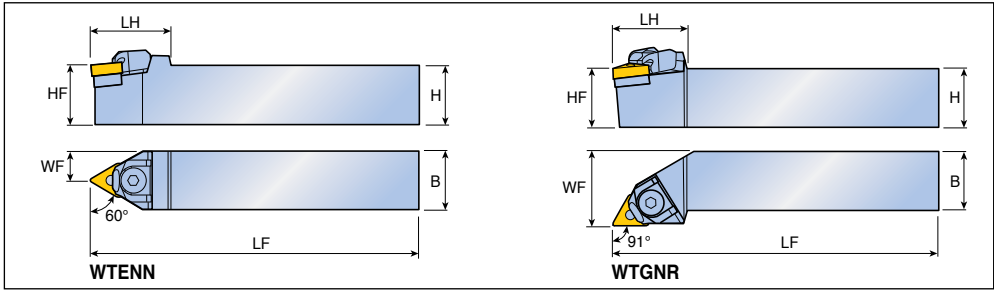
• Please refer to A164 page for COOL-BURST accessories

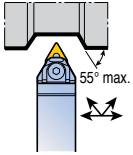
Wedge clamp type holders

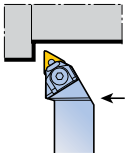

Approach angle	Designation	Dimension (mm)						Insert
		H	HF	B	LF	LH	WF	
60° 	WTENN 2020 K1304	20	20	20	125	28	10.0	TN... 1304... 
	2525 M1304	25	25	25	150	28	12.5	A291-A296, A349, A357
	WTENN 2020 K16	20	20	20	125	35	10.0	TN... 1604...
	2525 M16	25	25	25	150	35	12.5	
	2525 M22	25	25	25	150	38	12.5	TN... 2204...
	3225 P22	32	32	25	170	38	12.5	
	3232 P22	32	32	32	170	38	16.0	
91° 	WTGNR/L 2020 K1304	20	20	20	125	27	25	TN... 1304...
	2525 M1304	25	25	25	150	27	32	
	WTGNR/L 2020 K16	20	20	20	125	32	25	TN... 1604...
	2525 M16	25	25	25	150	32	32	
	2525 M22	25	25	25	150	38	32	TN... 2204...
	3232 P22	32	32	32	170	38	40	

Spare parts

Designation	Wedge clamp	Screw	Snap ring	Shim	Pin screw	Wrench	
...1304	WC 2.53	WCS 2.5	CSR 2	WST 2.52	WSS 2.52	L-W 2.5	
...16	WC 33	WCS 4	WSR 4	WST 33	WSS 33	L-W 3, L-W 2.5	
...22	WC 43	WCS 4	WSR 4	WST 43	WSS 43	L-W 3	

Wedge clamp type holders

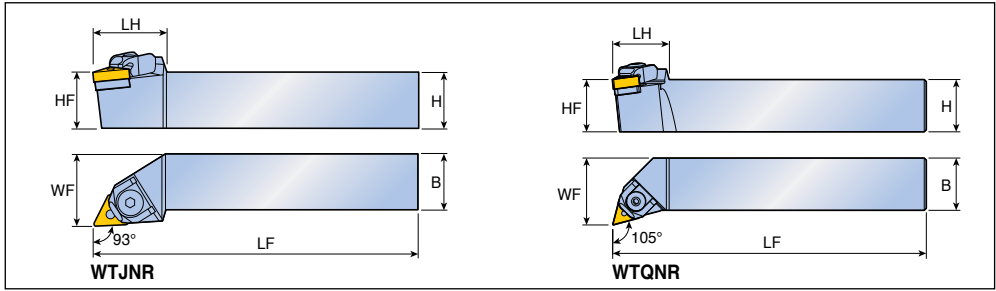

Approach angle	Designation	Dimension (mm)						Insert
		H	HF	B	LF	LH	WF	
93° 	WTJNR/L 2020 K1304	20	20	20	125	27	25	TN... 1304...
	2525 M1304	25	25	25	150	27	32	A291-A296,
	WTJNR/L 2020 K16	20	20	20	125	32	25	TN... 1604... A349, A357
	2525 M16	25	25	25	150	32	32	
	3225 P16	32	32	25	170	32	32	
	3232 P16	32	32	32	170	38	40	
	2525 M22	25	25	25	150	38	32	TN... 2204...
	3232 P22	32	32	32	170	38	40	
105° 	WTQNR/L 2020 K1304	20	20	20	125	27	25	TN... 1304...
	2525 M1304	25	25	25	150	27	32	

Spare parts

Designation	Wedge clamp	Screw	Snap ring	Shim	Pin screw	Wrench	
...1304	WC 2.53	WCS 2.5	CSR 2	WST 2.52	WSS 2.52	L-W 2.5	
...16	WC 33	WCS 4	WSR 4	WST 33	WSS 33	L-W 3, L-W 2.5	
...22	WC 43	WCS 4	WSR 4	WST 43	WSS 43	L-W 3	

Top clamp type holders for V bottom insert

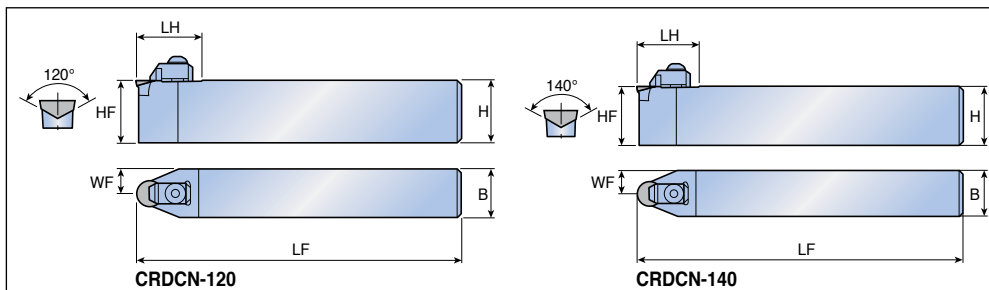

Approach angle	Designation	Dimension (mm)						Insert
		H	HF	B	LF	LH	WF	
45° 	CRDCN 2525 M06-120	25	25	25	150	28	12.5	RCGX 0606... A351
	3225 P06-120	32	32	25	170	28	12.5	
	3225 P09-120	32	32	25	170	30	12.5	RCGX 0907...
	3225 P12-120	32	32	25	170	32	12.5	RCGX 1207...
45° 	CRDCN 2525 M06-140	25	25	25	150	28	12.5	RCGX 0603...FT A362
	3225 P06-140	32	32	25	170	28	12.5	
	3225 P09-140	32	32	25	170	30	12.5	RCGX 0903...FT
	3225 P12-140	32	32	25	170	32	12.5	RCGX 1204...FT

Spare parts





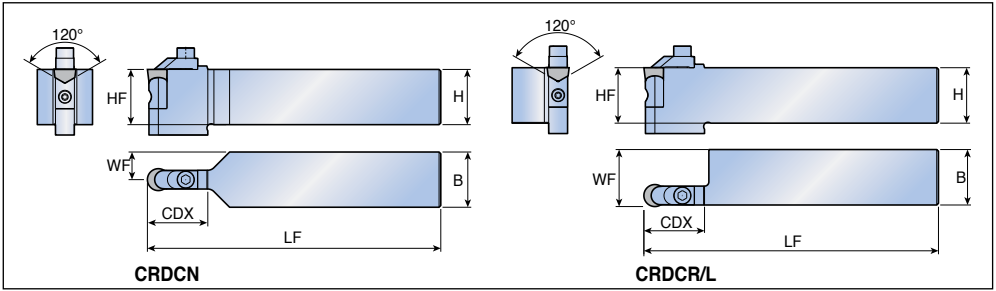

Designation	Clamp	Clamp screw	Shim	Shim screw		Wrench	
...06-120	BCL 6-20A	BH M6x1x25	CERS 06	SO 22050I	-	L-W 4	T 7
...09-120	BCL 6-20A	BH M6x1x25	CERS 09	-	BH M2.5x0.45x10	L-W 4, L-W 1.5	-
...12-120	BCL 6	BH M6x1x25	CERS 12	-	BH M2.5x0.45x10	L-W 4, L-W 1.5	-
...06-140	BCL 6-20A	BH M6x1x25	CBRS 06	SO 22050I	-	L-W 4	T 7
...09-140	BCL 6-20A	BH M6x1x25	CBRS 09	-	BH M2.5x0.45x10	L-W 4, L-W 1.5	-
...12-140	BCL 6	BH M6x1x25	CBRS 12	-	BH M2.5x0.45x10	L-W 4, L-W 1.5	-

CRDCN-T CRDCR/L-T

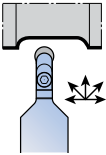

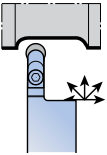





Narrow top clamp type holders for V bottom insert



Approach angle	Designation	Dimension (mm)							Insert
		H	HF	B	LF	CDX	WF		
	CRDCN 3232 P0907-120-T30	32	32	32	170	30	16	RCGX 0907... 	
	3232 P1207-120-T35	32	32	32	170	35	16	RCGX 1207...  A351	
	CRDCR/L 3232 P0907-120-T30	32	32	32	170	30	32.8	RCGX 0907... 	
	CRDCR 3225 P0907-120-T30	32	32	25	170	30	32.8	 A362	
	CRDCL 3232 P1207-120-T35	32	32	32	170	35	32.9	RCGX 1207... 	

Spare parts

Designation	Clamp	Clamp screw	Shim	Shim screw	Wrench	
						
...0907...	HCL 09-M	SH M5X0.8X12	CERS 09-T	SO 35124I	L-W 4	T 15
...1207...	HCL 12-M	SH M6X1X16	CERS 12-T	TS 40140AJ/HG	L-W 5	T 20

Top clamp type holders for V bottom insert

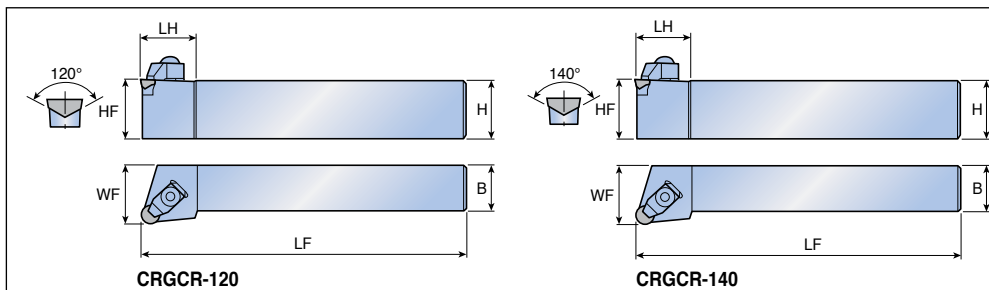

Approach angle	Designation	Dimension (mm)						Insert
		H	HF	B	LF	LH	WF	
90° 	CRGCR/L 2525 M06-120	25	25	25	150	28	32	RCGX 0606...
	3225 P06-120	32	32	25	170	28	32	A351
	3225 P09-120	32	32	25	170	30	32	RCGX 0907... RCGX 1207...
	3225 P12-120	32	32	25	170	32	32	
90° 	CRGCR/L 3225 P06-140	32	32	25	170	28	32	RCGX 0603...FT
	3225 P09-140	32	32	25	170	30	32	A362
	3225 P12-140	32	32	25	170	32	32	RCGX 0903...FT RCGX 1204...FT

Spare parts

Designation	Clamp	Clamp screw	Shim	Shim screw		Wrench	
...06...	BCL 6-20A	BH M6x1x25	CERS 06	SO 22050I	-	L-W 4	T 7
...09...	BCL 6-20A	BH M6x1x25	CERS 09	-	BH M2.5x0.45x10	L-W 4, L-W 1.5	-
...12...	BCL 6	BH M6x1x25	CERS 12	-	BH M2.5x0.45x10	L-W 4, L-W 1.5	-

TCBNR/L-CH TCKNR/L-CH





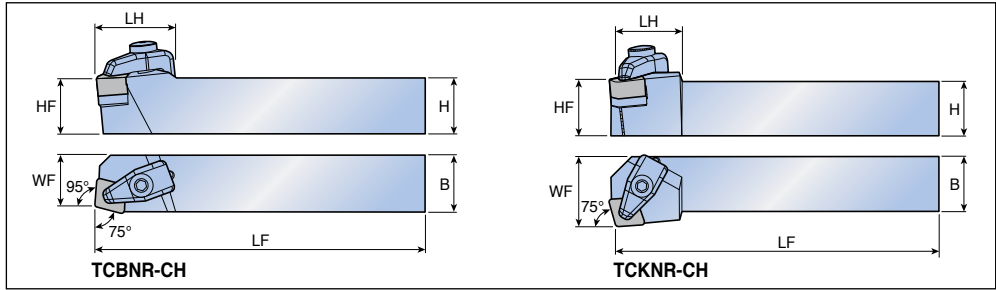



T-holders for CH dimple insert



Approach angle	Designation	Dimension (mm)						Insert
		H	HF	B	LF	LH	WF	
75°	TCBNR/L 2525 M12-CH	25	25	25	150	34.7	23	CNGX 1207...CH  A342
	3225 P12-CH	32	32	25	170	34	24	
75°	TCKNR/L 2525 M12-CH	25	25	25	150	28	32	

Spare parts



Designation	Clamp	Clamp screw	Spring	Shim	Shim screw	Wrench	
							
...12-CH	CCL-4	CSC 4	DSP 5	TSC 43	SO 400501	L-W 4	T 15

TDJNR/L-CH TDNNN-CH



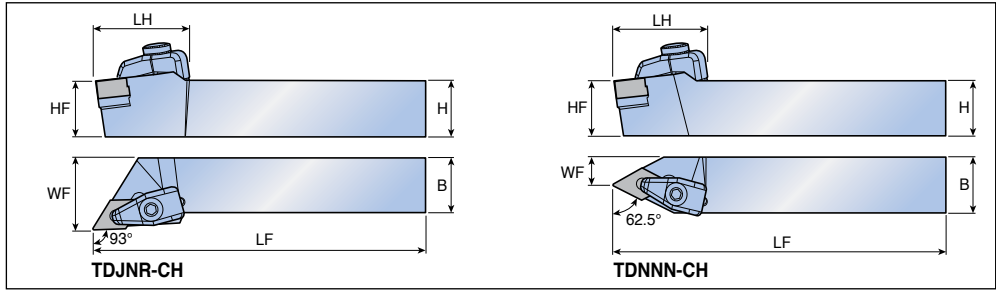





T-holders for CH dimple insert



Approach angle	Designation	Dimension (mm)							Insert
		H	HF	B	LF	LH	WF		
93°	TDJNR/L 2525 M15-CH	25	25	25	150	38	32	DNGX 1507...CH 	
	3225 P15-CH	32	32	25	170	38	32		
62.5°	TDNNN 2525 M15-CH	25	25	25	150	40	12.5	A343 	

Spare parts

Designation	Clamp	Clamp screw	Spring	Shim	Shim screw	Wrench	
...15-CH	 CCL-4	 CSC 4	 DSP 5	 TSD 43	 SO 400501	 L-W 4	 T 15

TSDNN-DA TSKNR-DA



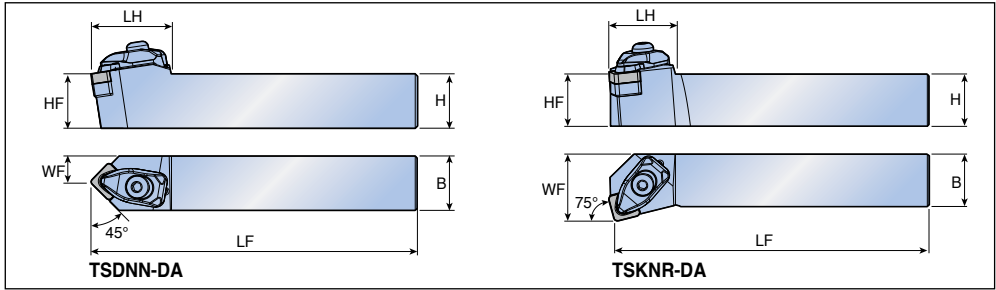

Combi clamp T-holders for DA dimple inserts



Approach angle	Designation	Dimension (mm)						Insert
		H	HF	B	LF	LH	WF	
45° 	TSDNN 2525 M1204-DA	25	25	25	150	37	12.5	SNGX 1204...DA  A356
75° 	TSKNR/L 2525 M1204-DA	25	25	25	150	29	32	

Spare parts

Designation	Clamp	Clamp screw	Spring	Shim	Shim screw	Wrench	
...1204-DA	 DCL S-4DA	 DLS 5	 DSP 5	 TSS 44	 SO 40050I	 L-W 4	 T 15

Combi clamp T-holders for flat inserts

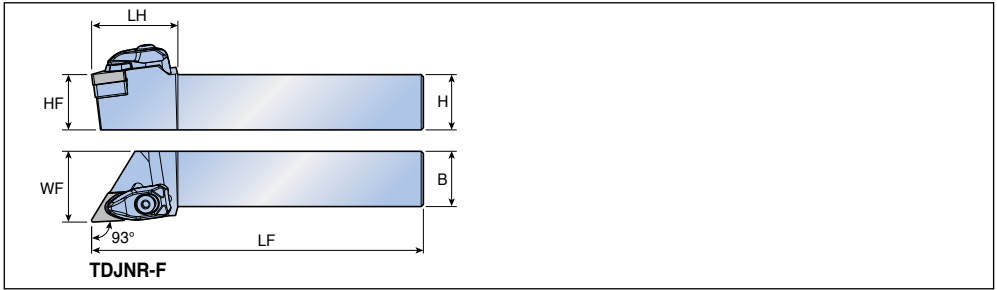

Approach angle	Designation	Dimension (mm)						Insert
		H	HF	B	LF	LH	WF	
93°	TDJNR/L 2525 M1504-F	25	25	25	150	39	32	DN...N 1504...
	2525 M1507-F	25	25	25	150	39	32	DN...N 1507...
	3232 P1507-F	32	32	32	170	39	40	

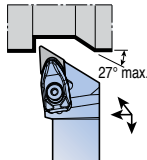

Spare parts

Designation	Clamp	Clamp screw	Spring	Shim	Shim screw	Wrench	
...1504-F	DCL S-4F	DLS 4	DSP 4	TSD 44	SO 40050I	L-W 3	T 15
...1507-F	DCL S-4F	DLS 4	DSP 4	TSD 42	SO 40050I	L-W 3	T 15

TRDNN-F TRGNR/L-F



Combi clamp T-holders for flat inserts

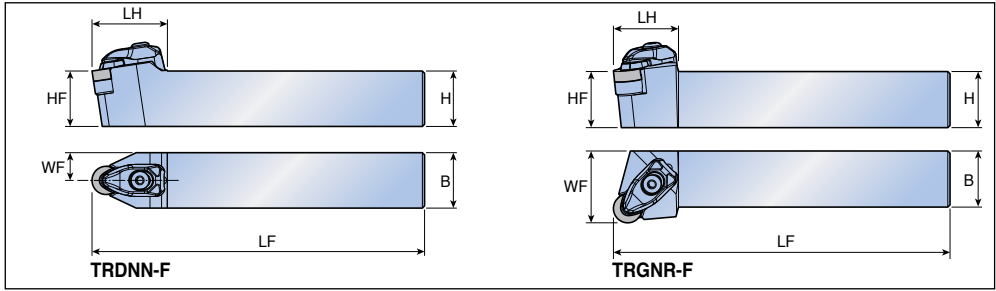

Approach angle	Designation	Dimension (mm)						Insert	
		H	HF	B	LF	LH	WF		
45° 	TRDNN	2525 M0903-F	25	25	25	150	27	12.5	RN...N 0903...
		2020 K1204-F	20	20	20	125	34	10	RN...N 1204... A345, A355
		2525 M1204-F	25	25	25	150	34	12.5	
		2020 K1207-F	20	20	20	125	34	10	RN...N 1207...
		2525 M1207-F	25	25	25	150	34	12.5	
		3225 P1207-F	32	32	25	170	34	12.5	
		3232 P1207-F	32	32	32	170	34	16	
90° 	TRGNR/L	2525 M0903-F	25	25	25	150	29	32	RN...N 0903...
		2020 K1204-F	20	20	20	125	29	25	RN...N 1204...
		2525 M1204-F	25	25	25	150	29	32	
		2020 K1207-F	20	20	20	125	29	25	RN...N 1207...
		2525 M1207-F	25	25	25	150	29	32	
		3225 P1207-F	32	32	25	170	29	32	
		3232 P1207-F	32	32	32	170	29	40	

• RN...N 1204/1207 are exchangeable, RN...N 1203 is not exchangeable on same holder

Spare parts



Designation	Clamp	Clamp screw	Spring	Shim		Shim screw	Wrench	
...0903-F	DCL S-3F	DLS 3	DSP 3	LSR 32	-	SO 40085I	L-W 2.5	T 15
...1204-F	DCL S-4F	DLS 4	DSP 4	-	TSR 45	SO 40050I	L-W 3	T 15
...1207-F	DCL S-4F	DLS 4	DSP 4	-	TSR 43	SO 40050I	L-W 3	T 15

TSDNN-F TSKNR/L-F

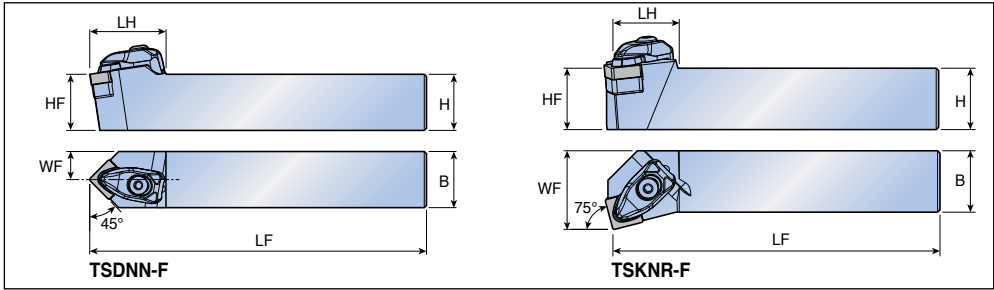

Combi clamp T-holders for flat inserts

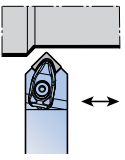

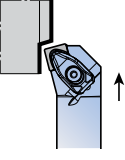
Approach angle	Designation	Dimension (mm)						Insert
		H	HF	B	LF	LH	WF	
45° 	TSDNN 2020 K1204-F	20	20	20	125	34	10	SN...N 1204... SN...N 1207...  A346, A356
	2525 M1204-F	25	25	25	150	34	12.5	
	2525 M1207-F	25	25	25	150	34	12.5	
	3225 P1207-F	32	32	25	170	34	12.5	
	3232 P1207-F	32	32	32	170	34	16	
75° 	TSKNR/L 2525 M1204-F	25	25	25	150	27	32	SN...N 1204...
	3232 P1204-F	32	32	32	170	27	40	
	2525 M1207-F	25	25	25	150	27	32	SN...N 1207...
	3232 P1207-F	32	32	32	170	27	40	

Spare parts

Designation	Clamp	Clamp screw	Spring	Shim	Shim screw	Wrench	
...1204-F	 DCL S-4F	 DLS 4	 DSP 4	 TSS 44	 SO 40050I	 L-W 3	 T 15
...1207-F	DCL S-4F	DLS 4	DSP 4	TSS 42	SO 40050I	L-W 3	T 15

TSRNR/L-F TSSNR/L-F



Combi clamp T-holders for flat inserts

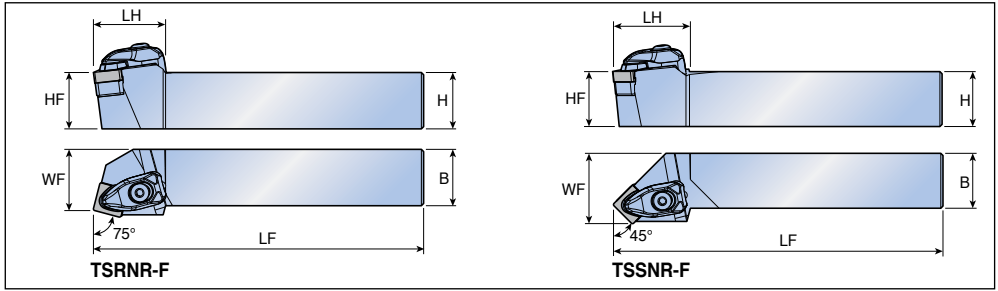

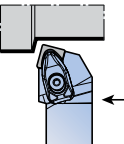
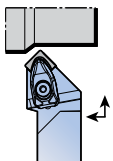
Approach angle	Designation	Dimension (mm)						Insert	
		H	HF	B	LF	LH	WF		
75° 	TSRNR/L 2525 M1204-F	25	25	25	150	32	27	SN...N 1204... SN...N 1207... A346, A356	
	3232 P1204-F	32	32	32	170	32	35		
	2525 M1207-F	25	25	25	150	32	27		
	3225 P1207-F	32	32	25	170	32	27		
	3232 P1207-F	32	32	32	170	32	35		
45° 	TSSNR/L 2525 M1204-F	25	25	25	150	35	32	SN...N 1204... SN...N 1207...	
	3232 P1204-F	32	32	32	170	35	40		
	2525 M1207-F	25	25	25	150	35	32		
	3232 P1207-F	32	32	32	170	35	40		

Spare parts

Designation	Clamp	Clamp screw	Spring	Shim	Shim screw	Wrench	
...1204-F	DCL S-4F	DLS 4	DSP 4	TSS 44	SO 400501	L-W 3	T 15
...1207-F	DCL S-4F	DLS 4	DSP 4	TSS 42	SO 400501	L-W 3	T 15

Combi clamp T-holders for flat inserts

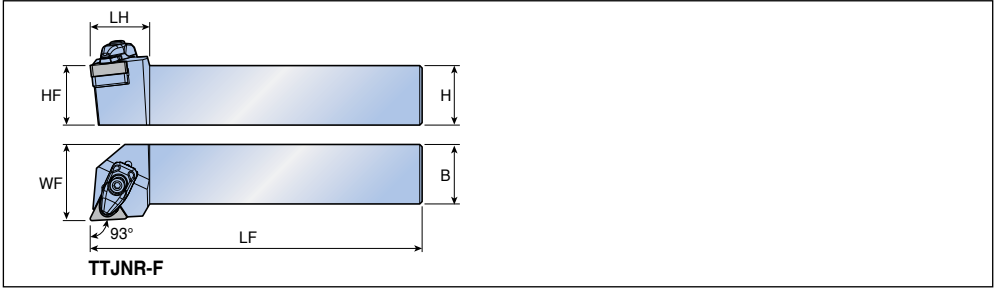

Approach angle	Designation	Dimension (mm)						Insert
		H	HF	B	LF	LH	WF	
93°	TTJNR/L 2020 K1604-F	20	20	20	125	25	25	TN...N 1604...
	2525 M1604-F	25	25	25	150	25	32	
	2020 K1607-F	20	20	20	125	25	25	TN...N 1607...
	2525 M1607-F	25	25	25	150	25	32	

• TNGN 1604/1607 Inserts are not exchangeable on same holder

Spare parts

Designation	Clamp	Clamp screw	Spring	Shim	Shim screw	Wrench	
...16-F	DCL S-3F	DLS 3	DSP 3	TST 33	SO 400501	L-W 3	T 15

2PLLNR/L 2PLBNR/L

Lever lock type holders with two pins

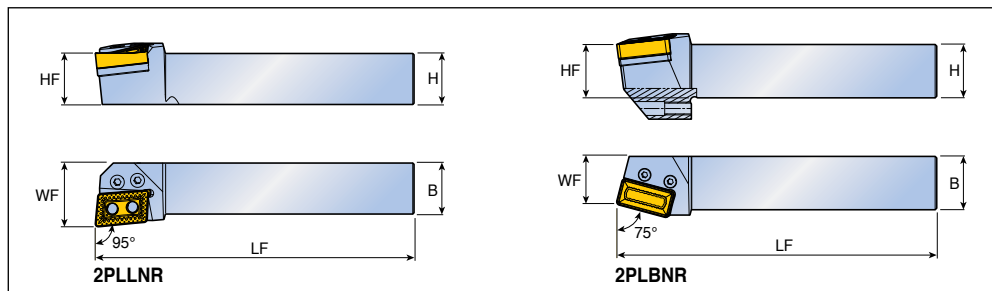

Approach angle	Designation	Dimension (mm)					Insert
		H	HF	B	LF	WF	
95°	2PLLNR/L 4040 S4012	40	40	40	250	50	LNMM 4012...HX A337
	5050 T4012	50	50	50	300	60	
75°	2PLBNR/L 5050 T5014	50	50	50	300	45	LNMX 5014...

Spare parts

Designation	Lever	Screw	Shim	Shim pin	Set screw	Wrench		
2PLLNR/L...	LCL 8	LCS 8-L39	LN 4025-T6.35-R/L	LSP 8	-	L-W 5		
2PLBNR/L...	LCL 8	LCS 8-L43	LN 5025-T6.35	LSP 8	SS M12x1.75x25	L-W 5		

TOP-RAIL holders

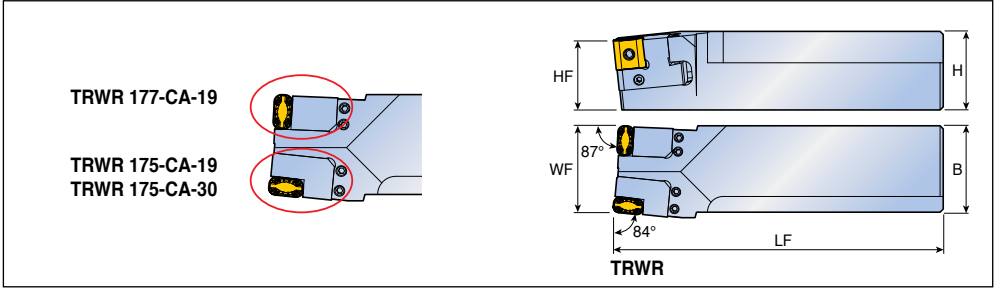

Approach angle	Designation	Dimension (mm)					Cartridge
		H	HF	B	LF	WF	
	* TRWR/L 50-55 TG	50	44	55	210	55	Left
							TRWR/L 175-CA-19
							TRWR/L 175-CA-30
							Right
							TRWR/L 177-CA-19

• *Marked: Cartridges are not included in TOP-RAIL holder, please order separately.

TOP-RAIL cartridges

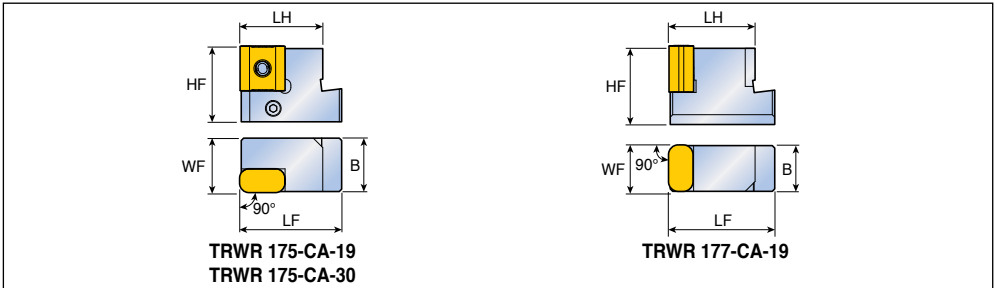

Designation	Dimension (mm)					Insert
	HF	B	LF	LH	WF	
TRWR/L 175-CA-19	32	22.6	43	35	23	LNMX 1919...
175-CA-30	32	22.6	43	35	23	LNMX 3019...
177-CA-19	32	18.6	43	35	19	LNMX 1919...

Spare parts

Designation	Screw	Pin	Lever	Screw	Wrench			
...50-55 TG	SS M6x1x16	PIN D5x13	-	-	L-W 3			
...CA...	-	-	LCL 5	LCS 5	L-W 3			

Hose

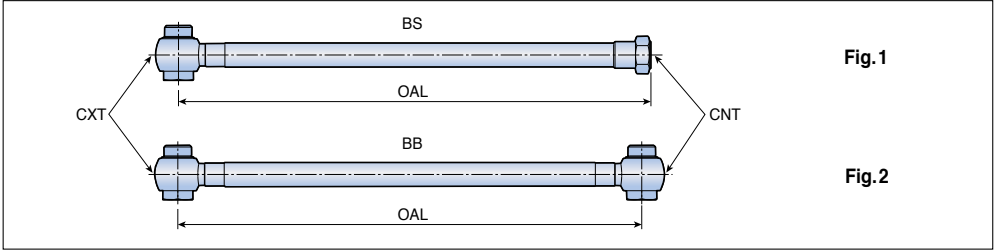

Designation	Dimension				Fig.
	OAL (mm)	CXT	CNT	Max.pressure (Bar)	
TB HOSE G1/8-7/16-200BS	200	G1/8"-28 BSPP	7/16"-20 UNF (Flare 37°)	260	1
G1/8-7/16-250BS	250	G1/8"-28 BSPP	7/16"-20 UNF (Flare 37°)	260	1
G1/8-G1/8-200BB	200	G1/8"-28 BSPP	G1/8"-28 BSPP	260	2
G1/8-G1/8-250BB	250	G1/8"-28 BSPP	G1/8"-28 BSPP	260	2
5/16-7/16-200BS	200	5/16"-24 UNF	7/16"-20 UNF (Flare 37°)	200	1
5/16-G1/8-200BS	200	5/16"-24 UNF	G1/8"-28 BSPP	200	1

• Hose is ordered separately

Spare parts

Designation	Bolt	Seal washer	
TB HOSE 5/16-7/16-200BS	TB BANJO BOLT 5/16" UNF	TB COPPER SEAL 5/16"	
TB HOSE G1/8-G1/8-200BB	TB BANJO BOLT G1/8"	TB COPPER SEAL 1/8"	
TB HOSE G1/8-G1/8-250BB	TB BANJO BOLT G1/8"	TB COPPER SEAL 1/8"	

• Bolt and Seal washer are ordered separately

Seal washer

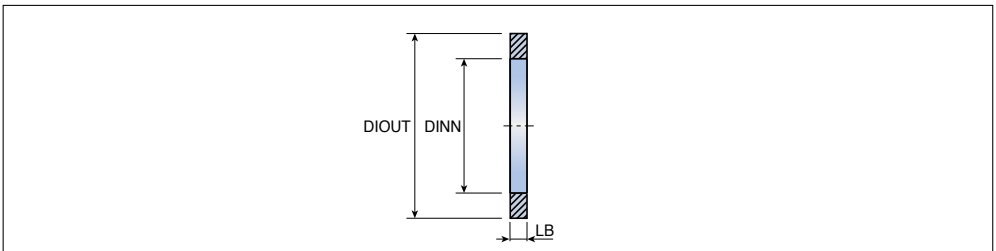

Designation	Dimension (mm)		
	DIOUT	DINN	LB
TB COPPER SEAL 1/8"	15	10	1
SEAL 5/16"	12	8	1

• Seal washer is ordered separately

Coupling system

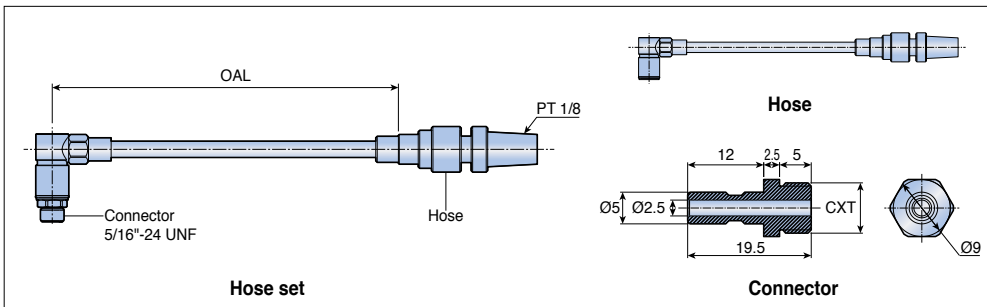

Components	Designation		Dimension		
			OAL (mm)	CXT	Maximum pressure (Bar)
Hose set	S-TB HOSE	R1/8-COUPLE-100	100	-	140
		R1/8-COUPLE-200	200	-	140
		R1/8-COUPLE-300	300	-	140
Hose	TB HOSE	R1/8-COUPLE-200	200	-	140
		R1/8-COUPLE-300	300	-	140
		R1/8-COUPLE	-	-	-
Connector	TB CONECTOR	5/16-COUPLE	-	5/16"-24 UNF	-
		G1/8-COUPLE	-	G1/8"-28 BSPP	-
		R1/8-COUPLE	-	PT 1/8"	-

- Hose set, hose and connector are ordered separately

Connector

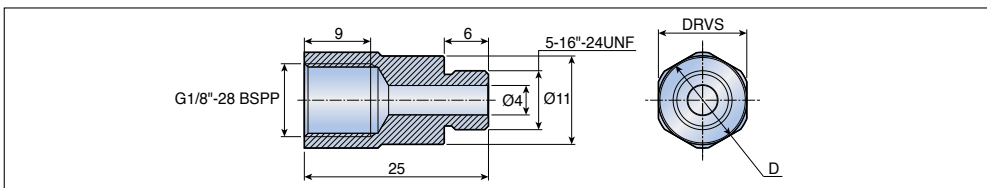

Designation	Dimension (mm)	
	D	DRVS
TB CONECTOR 5/16"-G1/8"	13	12
5/16"-G1/8"-12	12	11

- Connector is ordered separately

Adapter

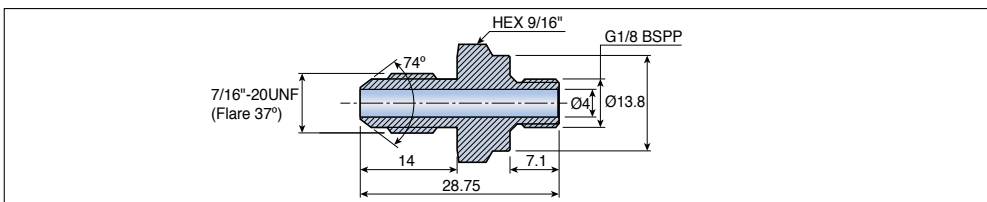

Designation
TB NIPPLE G1/8-7/16 UNF

- Adapter is ordered separately

QE1 SDJCR QE1 SDJCR-TB

Screw type modular heads for external turning

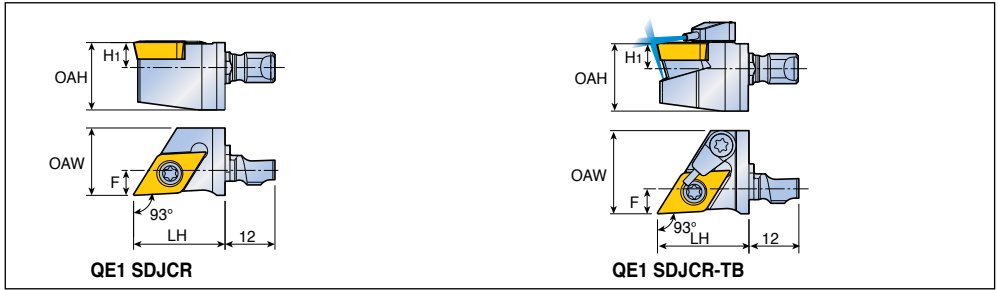

Approach angle	Designation	Dimension (mm)					Shank	Insert
		OAH	LH	OAW	H1	F		
93°	QE1 SDJCR 11	16.2	22.0	16.2	6.0	7.0	QE1 S12N-TB QE1 S16R-TB	DC... 11T3... A314-A317, A361
93°	QE1 SDJCR 11-TB	16.2	22.0	20.0	6.0	7.0		





Spare parts

Designation	Screw	Cooling unit	Wrench			
...11	SO 350801	-	T 15			
...11-TB	SO 350801	S-CU-TB	T 15			

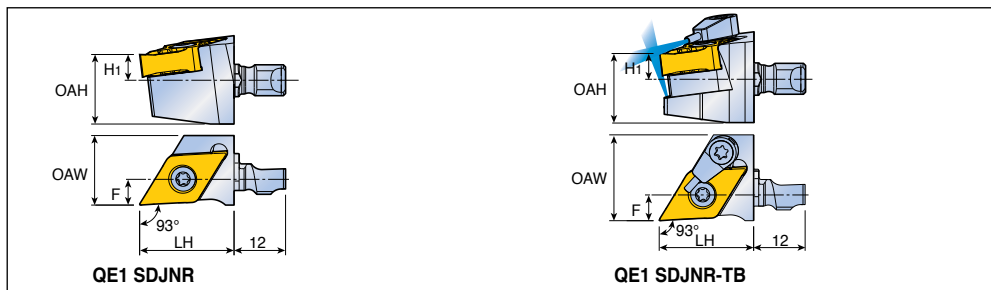

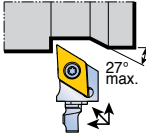
QE1 SDJNR QE1 SDJNR-TB

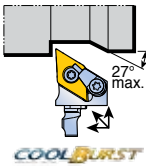
Screw type modular heads for external turning



Approach angle	Designation	Dimension (mm)					Shank	Insert
		OAH	LH	OAW	H1	F		
93° 	QE1 SDJNR 0803	16.2	22.0	16.2	6.0	7.0	QE1 S12N-TB QE1 S16R-TB	DN...X 0803...  A281
	QE1 SDJNR 1305	16.2	22.0	16.2	6.0	7.0		DN... 1305...  A276-A281
93° 	QE1 SDJNR 0803-TB	16.2	22.0	16.2	6.0	7.0		DN...X 0803...  A281
	QE1 SDJNR 1305-TB	16.2	22.0	20.0	6.0	7.0		DN... 1305...  A276-A281

Spare parts

Designation	Screw	Cooling unit	Wrench			
...0803	 TS 25D060/HG-P	 -	 T 7P			
...0803-TB	TS 25D060/HG-P	S-CU-TB	T 7P			
...1305	TG 40G110I	-	T 15			
...1305-TB	TG 40G110I	S-CU-TB	T 15			

QE1 SVJBR QE1 SVJBR-TB

Screw type modular heads for external turning

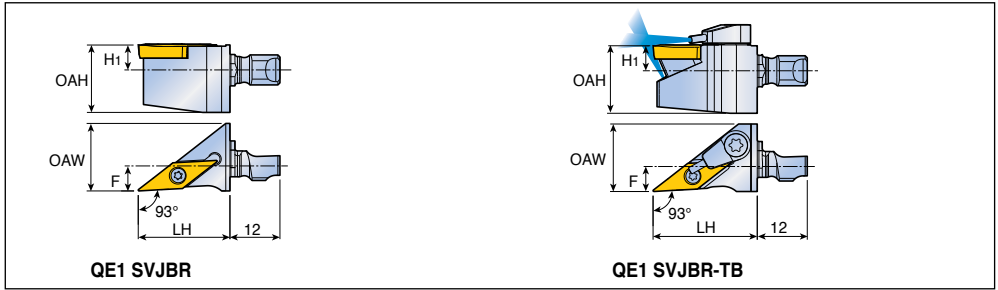

Approach angle	Designation	Dimension (mm)					Shank	Insert
		OAH	LH	OAW	H ₁	F		
93°	QE1 SVJBR 11	16.2	22.0	16.2	6.0	7.0	QE1 S12N-TB QE1 S16R-TB	VB.. 1103.. A330, A331, A365
93°	QE1 SVJBR 11-TB	16.2	25.0	16.2	6.0	7.0		

Spare parts

Designation	Screw	Cooling unit	Wrench			
...11	SO 25065I	-	T 7			
...11-TB	SO 25065I	S-CU-TB	T 7			

QE1 SVJCR QE1 SVJCR-TB

Screw type modular heads for external turning

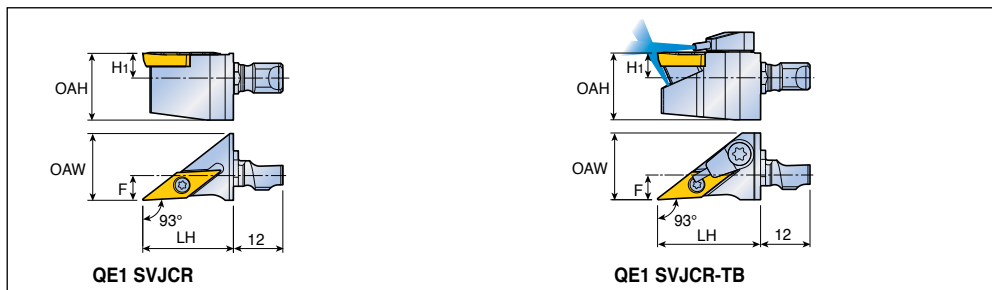

Approach angle	Designation	Dimension (mm)					Shank	Insert
		OAH	LH	OAW	H1	F		
93°	QE1 SVJCR 11	16.2	22.0	16.2	6.0	7.0	QE1 S12N-TB QE1 S16R-TB	VC... 1103... A330, A331, A365
93°	QE1 SVJCR 11-TB	16.2	25.0	16.2	6.0	7.0		

Spare parts





Designation	Screw	Cooling unit	Wrench			
...11	SO 25065I	-	T 7			
...11-TB	SO 25065I	S-CU-TB	T 7			

QE1B SVXCR QE1B SVXCR-TB

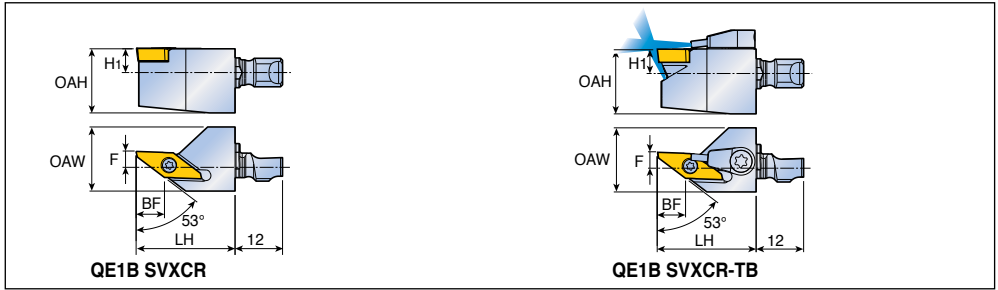

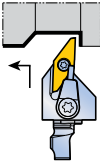

Screw type modular heads for back turning



Approach angle	Designation	Dimension (mm)						Shank	Insert	
		OAH	LH	OAW	BF	H1	F			
53° 	QE1B SVXCR 11	16.2	25.0	16.2	7.2	6.0	3.0	QE1 S12N-TB QE1 S16R-TB	BTVC 1103..  A308	
53°  COOLBURST	QE1B SVXCR 11-TB	16.2	25.0	16.2	7.2	6.0	3.0	QE1 S12N-TB QE1 S16R-TB	BTVC 1103..  A308	

Spare parts

Designation	Screw	Cooling unit	Wrench			
...11	SO 25065I 	- 	T 7 			
...11-TB	SO 25065I	S-CU-TB	T 7			

QE1Y SDJCR QE1Y SDJCR-TB

Screw type Y-axis modular heads

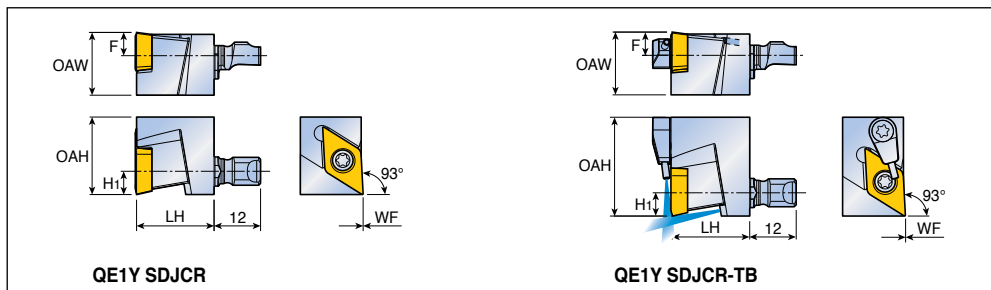

Approach angle	Designation	Dimension (mm)						Shank	Insert
		OAW	OAH	LH	WF	H1	F		
93°	QE1Y SDJCR 11	16.2	20.0	20.0	0.0	6.0	7.0	QE1 S12N-TB QE1 S16L-TB	DC.. 11T3.. A314-A317, A361
93°	QE1Y SDJCR 11-TB	16.2	25.5	20.0	0.0	6.0	7.0		

Spare parts

Designation	Screw	Cooling unit	Wrench			
...11	SO 35080I	-	T 15			
...11-TB	SO 35080I	S-CU-TB	T 15			

QE1 S12N-TB

High pressure coolant shanks for FLEX-TURN modular head

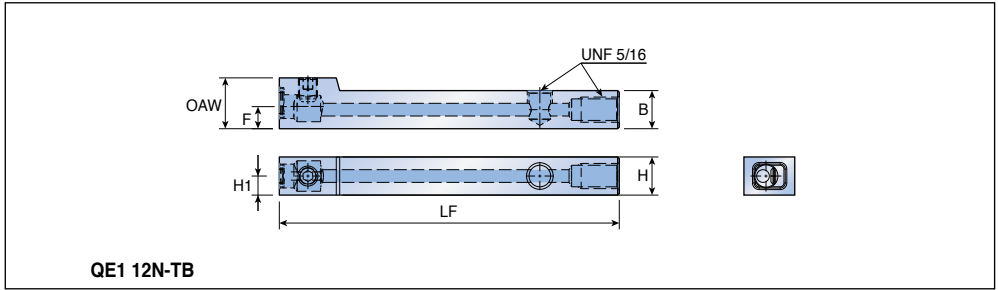

Designation	Dimension (mm)						Modular head
	H	H1	B	LF	OAW	F	
QE1 S12N-TB	12	6	12	107	16	7	QE1...R(-TB) QE1B...R(-TB) A166-A171 QE1Y...R(-TB)

Head designation	70 bar flow rate (ℓ/min)	100 bar flow rate (ℓ/min)	140 bar flow rate (ℓ/min)
QE1 SDJCR-TB *	9-11	11-13	14-16
QE1B SVXCR-TB	8-10	9-11	11-13
QE1Y SDJCR-TB	13-15	15-17	18-20

* QE1 SVJBR, SVJCR, SDJNR same flow rate

Spare parts

Designation	Screw	Plug	Wrench	
QE1...-TB	SS M6F-7	PLG 5/16 UNF	L-W 3	L-W 5/32

* Please refer to **A165** page for COOL-BURST accessories

QE1 S16R/L-TB

High pressure coolant shanks for FLEX-TURN modular head

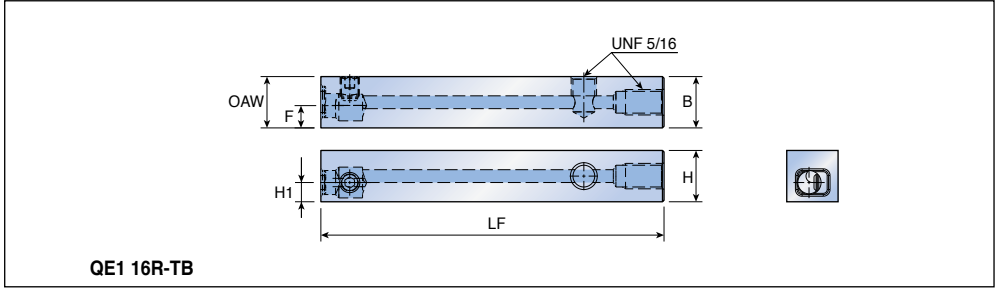

Designation	Dimension (mm)						Modular head
	H	H1	B	LF	OAW	F	
QE1 S16R-TB	16	6	16	107	16	7	QE1...R(-TB)
QE1 S16L-TB	16	6	16	107	16	7	QE1B...R(-TB) A166-A171 QE1Y...R(-TB)

Head designation	70 bar flow rate (ℓ/min)	100 bar flow rate (ℓ/min)	140 bar flow rate (ℓ/min)
QE1 SDJCR-TB *	9-11	11-13	14-16
QE1B SVXCR-TB	8-10	9-11	11-13
QE1Y SDJCR-TB	13-15	15-17	18-20

* QE1 SVJBR, SVJCR, SDJNR same flow rate

Spare parts

Designation	Screw	Plug	Wrench	
QE1...-TB	SS M6F-7	PLG 5/16 UNF	L-W 3	L-W 5/32

Please refer to A165 page for COOL-BURST accessories

C4 - T C L N R

1 2 3 4 5 6

1 Coupling size

	Symbol	DCONMS(mm)
	C4	40
	C5	50
	C6	63

2 Clamping system

P	C	S	M	T	W	H
Lever lock	Top clamp	Screw clamp	Multi lock	T-holder	Wedge clamp	Hook lever

3 Insert shape

C	D	E	H	K	R	S	T	V	W

4 Approach angle

Symbol	Shape	Offset	Symbol	Shape	Offset	Symbol	Shape	Offset
A		x	J		o	V		x
			K		o	W		o
B		x	L		o	X	Special angle	
			M		x	C*		x
D		x	N		x	H*		o
E		x	R		o	Q*		o
F		o	S		o			
G		o	T		o			
			U		o			

* TaeguTec standard

27 055 - 09

7

8

9

10

5 Insert clearance angle

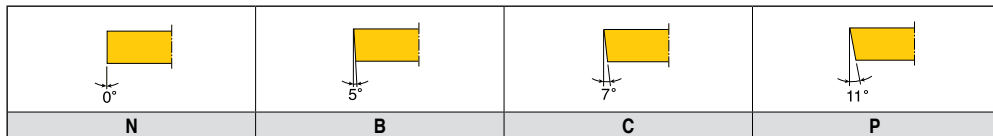

6 Hand of tool

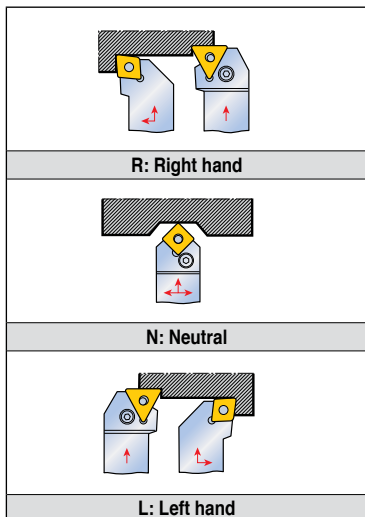

7 WF dimension (mm)

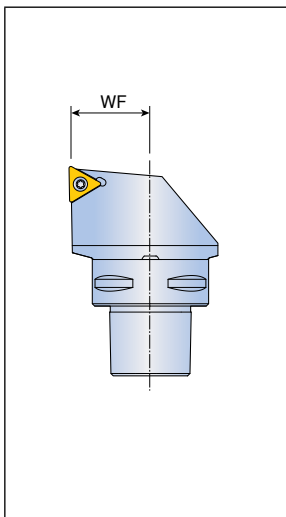

8 Tool length (mm)

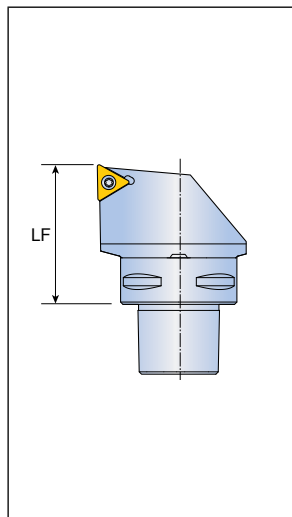

9 Cutting edge length

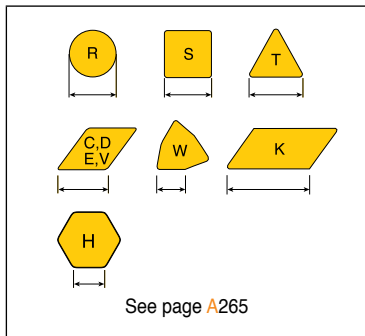

10 Manufacturer's type designation

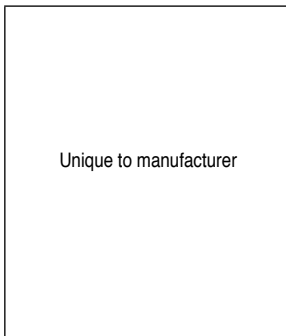

HCLNR/L HDJNR/L



Hook lever type holders with C-ADAPTER

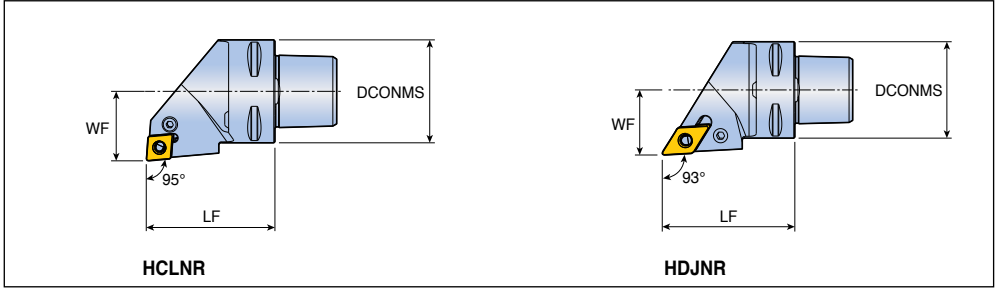

Approach angle	Designation	Dimension (mm)			Insert
		DCONMS	WF	LF	
95°	C4-HCLNR/L 27050-0904	40	27	50	CN... 0904... RHINO TURN A266, A268-A273
93°	C4-HDJNR/L 27055-1305	40	27	55	DN... 1305... RHINO TURN A276-A281

Spare parts





Designation	Lever	Screw	Shim		Shim pin	Shim pin punch	Nozzle	Wrench
C4...HCLNR/L	LCL 09-NX	LCS 3	LSC 32	-	LSP 3A	SPP 3-4	NZ 83	L-W 2.5
C4...HDJNR/L	LCL 11-NX	LCS 4	-	LSD 3.52	LSP 4	SPP 3-4	NZ 83	L-W 3

HSSNR/L HTGNR/L HTJNR/L

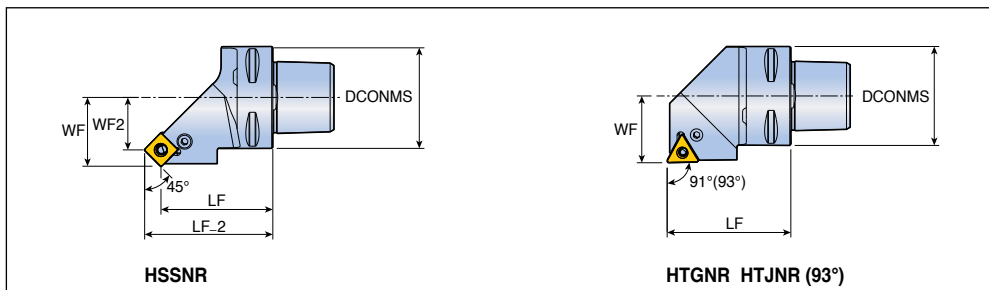

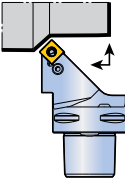

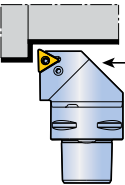





Hook lever type holders with C-ADAPTER







Approach angle	Designation	Dimension (mm)					Insert
		DCONMS	WF	WF2	LF	LF_2	
45° 	C4-HSSNR/L 27042-0904	40	27	20.6	44	50.3	SN... 0904...  A286-A289
91°(93°) 	C4-HTGNR/L 27050-1304	40	27	-	50	-	TN... 1304...  A291-A296
	C4-HTJNR/L 27050-1304	40	27	-	50	-	

Spare parts

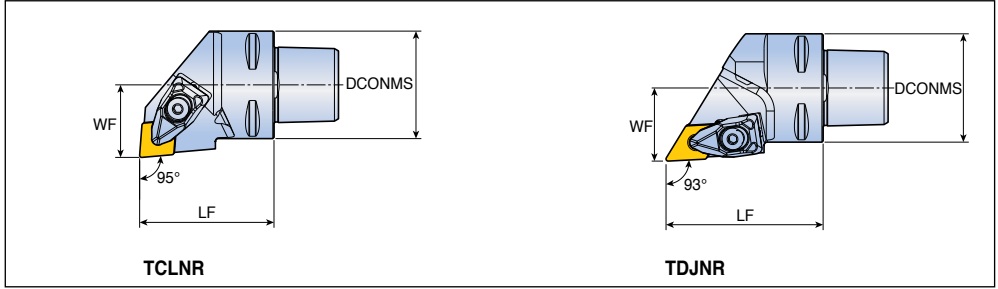

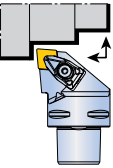

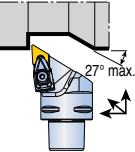



Designation	Lever	Screw	Shim		Shim pin	Shim pin punch	Nozzle	Wrench
								
C4...0904	LCL 09-NX	LCS 3	LSS 32A	-	LSP 3A	SPP 3-4	NZ 83	L-W 2.5
C4...1304	LCL 08-NX	LCS 3-NX	-	LST 2.51.8	LSP 3B	SPP 3-3L	NZ 83	L-W 2.5

T-holders with C-ADAPTER



Approach angle	Designation	Dimension (mm)			Insert
		DCONMS	WF	LF	
95° 	C4-TCLNR/L 27050-12	40	27	50	CN...1204...  A266, A268-A275,
	C5-TCLNR/L 35060-12	50	35	60	
	C6-TCLNR/L 45065-12	63	45	65	
	C4-TCLNR/L 27055-16	40	27	55	CN...1606... A341, A342, A353
	C5-TCLNR/L 35060-19	50	35	60	
	C6-TCLNR/L 45065-19	63	45	65	
93° 	C4-TDJNR/L 27058-1504	40	27	58	DN...1504...  A276-A281, A343, A354
	C4-TDJNR/L 27058-1506	40	27	58	
	C5-TDJNR/L 35060-1504	50	35	60	
	C5-TDJNR/L 35060-1506	50	35	60	DN...1506... DN...1504... DN...1504... DN...1506...
	C6-TDJNR/L 45065-1504	63	45	65	
	C6-TDJNR/L 45065-1506	63	45	65	

Spare parts

Designation	Clamp	Clamp screw	Spring	Shim		Shim screw	Nozzle	Wrench	
									
C4...12	DLM 4	DLS 4	DSP 4	TSC 44	-	SO 40050I	NZ 83	L-W 3	T 15
...12	DLM 4	DLS 4	DSP 4	TSC 44	-	SO 40050I	NZ 104	L-W 3	T 15
...16	DLM 5	DLS 5	DSP 5	TSC 54	-	SO 50090I	NZ 83	L-W 4	T 20
...19	DLM 6	DLS 5	DSP 5	LSC 63	-	SO 80180I	NZ 104	L-W 4	T 20
...1504	DLM 4	DLS 4	DSP 4	-	TSD 44	SO 40050I	NZ 83	L-W 3	T 15
C4...1506	DLM 4	DLS 4	DSP 4	-	TSD 43	SO 40050I	NZ 83	L-W 3	T 15
...1506	DLM 4	DLS 4	DSP 4	-	TSD 43	SO 40050I	NZ 104	L-W 3	T 15

T-holders with C-ADAPTER

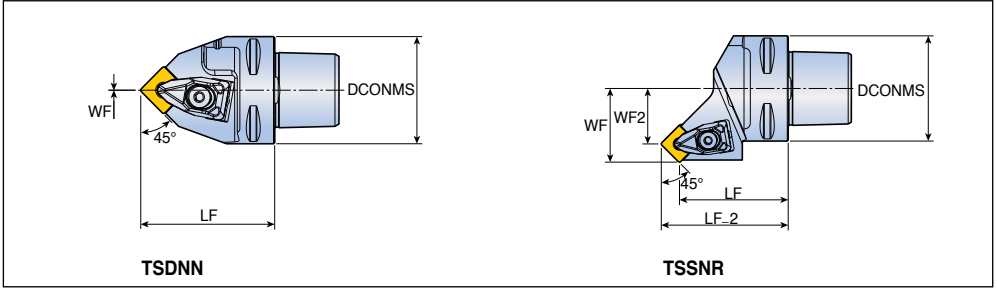





Approach angle	Designation	Dimension (mm)					Insert
		DCONMS	WF	WF2	LF	LF_2	
45°	C4-TSDNN 00050-12	40	-	-	50	-	SN...1204... A284, A286-A290
	C5-TSDNN 00060-12	50	-	-	60	-	
	C6-TSDNN 00065-12	63	-	-	65	-	
45°	C4-TSSNR/L 27042-12	40	27	18.7	42	50.3	
	C5-TSSNR/L 35052-12	50	35	26.7	52	60.3	
	C6-TSSNR/L 45056-12	63	45	36.7	56	64.3	

Spare parts

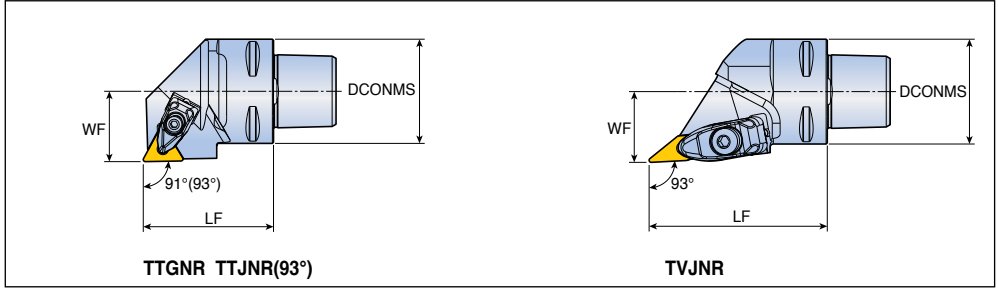

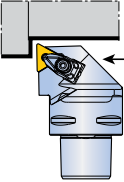

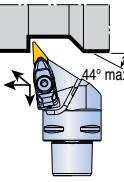

Designation	Clamp	Clamp screw	Spring	Shim	Shim screw	Nozzle	Wrench	
C4...12	DLM 4	DLS 4	DSP 4	TSS 44	SO 40050I	NZ 83	L-W 3	T 15
...12	DLM 4	DLS 4	DSP 4	TSS 44	SO 40050I	NZ 104	L-W 3	T 15

T-holders with C-ADAPTER



Approach angle	Designation	Dimension (mm)			Insert
		DCONMS	WF	LF	
91°(93°) 	C4-TTGNR/L 27050-16	40	27	50	TN...1604...  A291-A296, A349, A357
	C5-TTGNR/L 35060-16	50	35	60	
	C6-TTGNR/L 45065-16	63	45	65	
	C4-TTJNR/L 27050-16	40	27	50	
	C5-TTJNR/L 35060-16	50	35	60	
	C6-TTJNR/L 45065-16	63	45	65	
93° 	C4-TVJNR/L 27068-16	40	27	68	VN...1604...  A297, A298, A358
	C5-TVJNR/L 35065-16	50	35	65	
	C6-TVJNR/L 45068-16	63	45	68	

Spare parts

Designation	Clamp	Clamp screw	Spring	Shim		Shim screw	Nozzle	Wrench	
C4...TT...16									
...TT...16	DLM 3	DLS 3	DSP 3	TST 33	-	SO 35080I	NZ 83	L-W 2.5	T 15
C4...TV...16	DLM 3V	DLS 5	DSP 5	-	TSV 33	SO 35080I	NZ 83	L-W 4	T 15
...TV...16	DLM 3V	DLS 5	DSP 5	-	TSV 33	SO 35080I	NZ 104	L-W 4	T 15

T-holders with C-ADAPTER

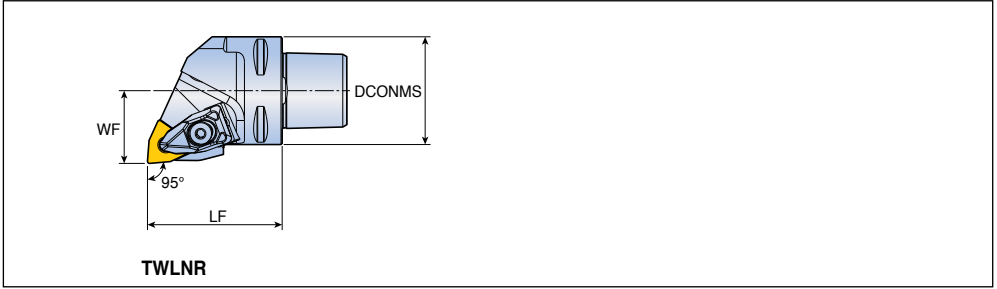

Approach angle	Designation	Dimension (mm)			Insert
		DCONMS	WF	LF	
95°	C4-TWLNR/L 27050-06	40	27	50	WN...G 0604...
	C4-TWLNR/L 27050-08	40	27	50	WN... 0804...
	C5-TWLNR/L 35060-08	50	35	60	A300-A302, A350, A359
	C6-TWLNR/L 45065-08	63	45	65	

Spare parts

Designation	Clamp	Clamp screw	Spring	Shim	Shim screw	Nozzle	Wrench	
...06								
C4...08	DLM 3	DLS 3	DSP 3	PSW 32	SO 40090I	NZ 83	L-W 2.5	T 15
...08	DLM 4	DLS 4	DSP 4	TSW 44	SO 40050I	NZ 83	L-W 3	T 15
	DLM 4	DLS 4	DSP 4	TSW 44	SO 40050I	NZ 104	L-W 3	T 15

TZQNR/L-TB



High pressure T-holders with C-ADAPTER

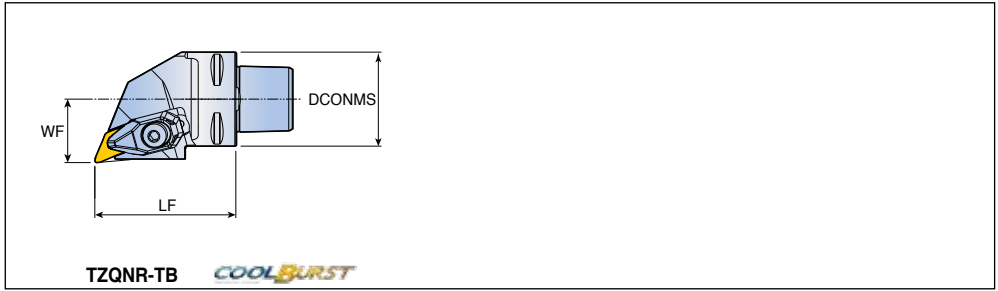

Approach angle	Designation	Dimension (mm)			Insert
		DCONMS	WF	LF	
ZNMV 23°(BWT) 95°(FWT)	C4-TZQNR/L 27060-1410-TB	40	27	60	ZNMV 1410... POSSTURN A307
	C5-TZQNR/L 35060-1410-TB	50	35	60	
	C6-TZQNR/L 45065-1410-TB	60	45	65	

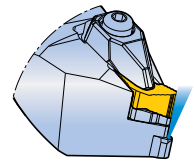
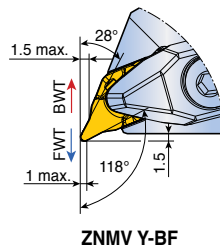
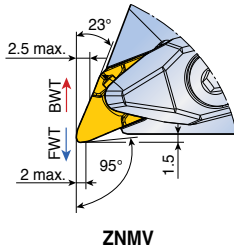
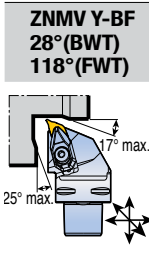
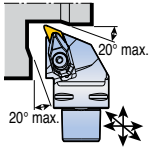

- BWT: Backward turning
- FWT: Forward turning

Spare parts





Designation	Clamp	Clamp screw	Spring	Shim	Shim screw	Wrench	
...-TB	DLM 3.3Z-NV	DLS 5	DSP 5	TSZ 140310	TS 35083/HG	L-W 4	T 10

SCLCR/L SDJCR/L

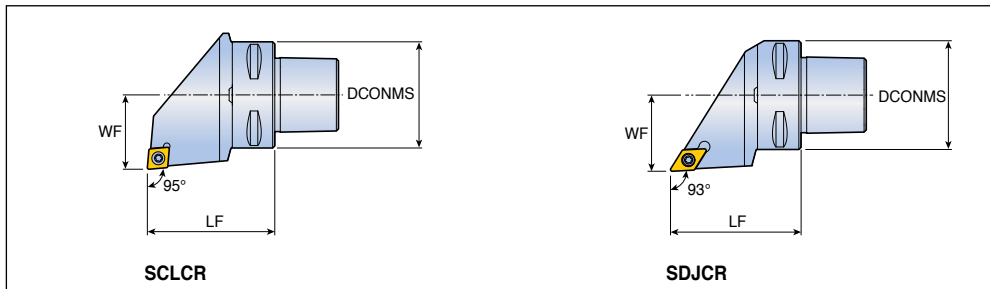

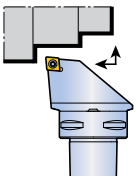

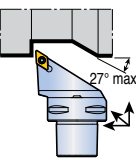



Screw type holders with C-ADAPTER



Approach angle	Designation	Dimension (mm)			Insert	
		DCONMS	WF	LF		
 95°	C4-SCLCR/L 27050-09	40	27	50	CC... 09T3...  A309-A312, A360	
	C5-SCLCR/L 35060-09	50	35	60		
	C6-SCLCR/L 45065-09	63	45	65		
	 93°	C4-SDJCR/L 27050-11	40	27	50	DC... 11T3...  A314-A317, A361
		C5-SDJCR/L 35060-11	50	35	60	
		C6-SDJCR/L 45065-11	63	45	65	

Spare parts





Designation	Screw	Shim		Shim screw	Nozzle	Wrench	
							
C4...09	SO 35124I	SSC 32	-	SO 50090S	NZ 83	T 15	L-W 3.5
...09	SO 35124I	SSC 32	-	SO 50090S	NZ 104	T 15	L-W 3.5
C4...11	SO 35124I	-	SSD 32	SO 50090S	NZ 83	T 15	L-W 3.5
...11	SO 35124I	-	SSD 32	SO 50090S	NZ 104	T 15	L-W 3.5
C4...12	SO 45130I	SSC 43N	-	SO 60105S	NZ 83	T 20	L-W 5
...12	SO 45130I	SSC 43N	-	SO 60105S	NZ 104	T 20	L-W 5

SRDCN STGCR/L STJCR/L

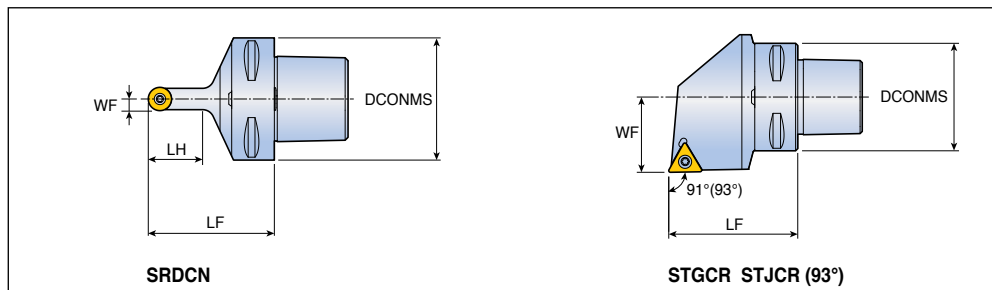

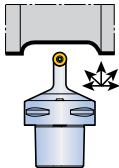

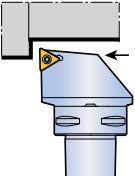



Screw type holders with C-ADAPTER





Approach angle	Designation	Dimension (mm)				Insert
		DCONMS	WF	LF	LH	
45° 	C4-SRDCN 00050-10A	40	5	50	25	RC...T 10T300  A320
	C5-SRDCN 00060-10A	50	5	60	25	
	C6-SRDCN 00065-10A	63	5	65	25	
	RC...T 120400	C4-SRDCN 00050-12A	40	6	50	28
		C5-SRDCN 00060-12A	50	6	60	28
		C6-SRDCN 00065-12A	63	6	65	28
91°(93°) 	C4-STGCR/L 27050-16	40	27	50	-	TC... 16T3...  A325, A363, A364
	C5-STGCR/L 35060-16	50	35	60	-	
	C4-STJCR/L 27050-16	40	27	50	-	
	C5-STJCR/L 35060-16	50	35	60	-	

Spare parts



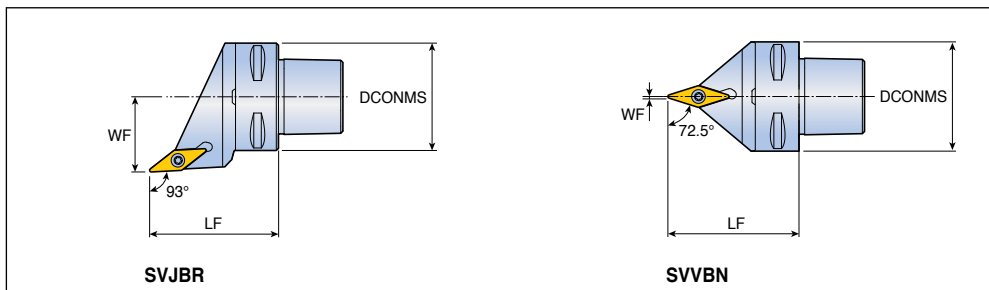

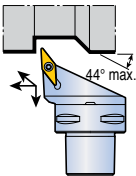

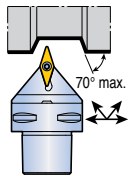
Designation	Screw	Shim		Shim screw	Nozzle	Wrench	
							
C4...10A	TS 40097I	TRC 3-0	-	SR TC-3	NZ 62	T 15	-
...10A	TS 40097I	TRC 3-0	-	SR TC-3	NZ 62	T 15	-
C4...12A	SO 40050I	TRC 4-0	-	SR TC-4S	NZ 62	T 15	-
...12A	SO 40050I	TRC 4-0	-	SR TC-4S	NZ 62	T 15	-
C4...16	SO 35124I	-	SST 32	SO 50090S	NZ 83	T 15	L-W 3.5
...16	SO 35124I	-	SST 32	SO 50090S	NZ 104	T 15	L-W 3.5

Screw type holders with C-ADAPTER



Approach angle	Designation	Dimension (mm)			Insert
		DCONMS	WF	LF	
93° 	C4-SVJBR/L 27050-16	40	27	50	VB...T 1604...  A330, A331, A365
	C5-SVJBR/L 35060-16	50	35	60	
	C6-SVJBR/L 45065-16	63	45	65	
72.5° 	C4-SVVBN 00050-16	40	0.6	50	
	C5-SVVBN 00060-16	50	0.6	60	
	C6-SVVBN 00065-16	63	0.6	65	

Spare parts

Designation	Screw	Shim	Shim screw	Nozzle	Wrench			
								
C4...16	SO 35124I	SSV 32	SO 50090S	NZ 83	T 15	L-W 3.5		
...16	SO 35124I	SSV 32	SO 50090S	NZ 104	T 15	L-W 3.5		

C-ADAPTERs with HUSH-BORE head connection

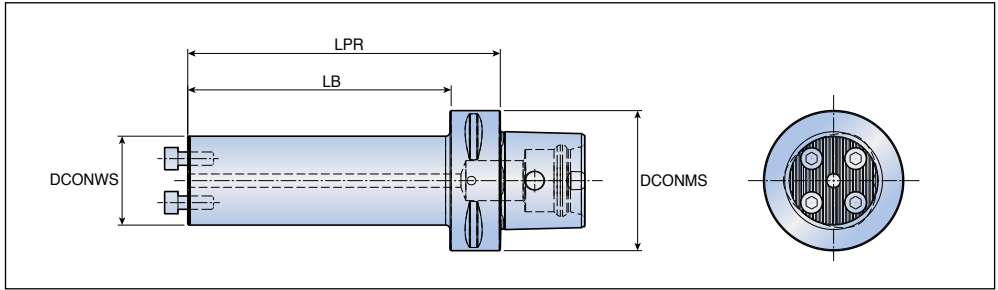

Designation	Dimension (mm)				Coolant hole
	DCONMS	DCONWS	LPR	LB	
C4-CS16A-2.5D	40	16	40	20	●
C4-CS20A-2.5D	40	20	50	30	●
C4-CS25A-2.5D	40	25	55	35	●
C4-CS32A-2.5D	40	32	75	55	●
C4-CS40A-3D	40	40	80	80	●
C5-CS16A-2.5D	50	16	40	20	●
C5-CS20A-2.5D	50	20	50	30	●
C5-CS25A-2.5D	50	25	55	35	●
C5-CS32A-2.5D	50	32	75	55	●
C5-CS40A-3D	50	40	100	80	●
C6-CS16A-2.5D	63	16	40	18	●
C6-CS20A-2.5D	63	20	50	28	●
C6-CS25A-2.5D	63	25	65	43	●
C6-CS32A-3D	63	32	90	68	●
C6-CS32A-4D	63	32	125	103	●
C6-CS40A-3D	63	40	100	78	●
C6-CS40A-4D	63	40	140	118	●
C6-CS16E-5D	63	16	80	58	●
C6-CS20E-5D	63	20	100	78	●
C6-CS25E-5D	63	25	115	93	●
C6-CS32E-5D	63	32	150	128	●
C6-CS40E-5D	63	40	185	163	●

• 5D : Carbide core type

Spare parts

Designation	Screw	Wrench			
CS16	SH M3x0.5X10	L-W 2.5			
CS20	SH M3.5x0.6X10	L-W 2.5			
CS25	SH M4x0.7X12	L-W 3.0			
CS32	SH M5x0.8X12	L-W 4.0			
CS40	SH M6x1X16	L-W 5.0			

• Please refer to A253-A262 pages for HUSH-BORE heads

Reduction sleeves for bars, used in holders with exchangeable adaptation

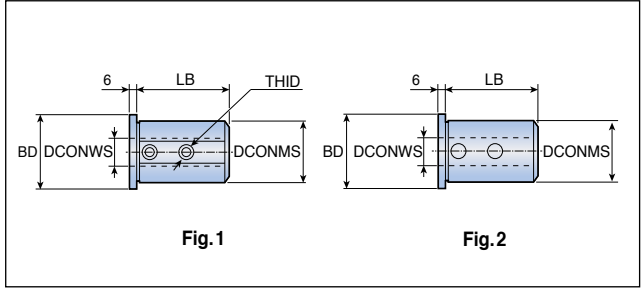

Designation	Dimension (mm)					Fig.
	DCONMS	DCONWS	BD	LB	THID	
SC 25T6A	25	6	31	56	M6	1
25T8A	25	8	31	56	M8	1
25T10A	25	10	31	56	M8	1
25T12A	25	12	31	56	M8	1
25T16B	25	16	31	56	-	2
25T20B	25	20	31	56	-	2
SC 40T6A	40	6	46	60	M6	1
40T8A	40	8	46	60	M8	1
40T10A	40	10	46	60	M8	1
40T12A	40	12	46	60	M8	1
40T16B	40	16	46	60	-	2
40T20B	40	20	46	60	-	2
40T25B	40	25	46	60	-	2
40T32B	40	32	46	60	-	2
SC 50T6A	50	6	56	70	M6	1
50T8A	50	8	56	70	M8	1
50T10A	50	10	56	70	M8	1
50T12A	50	12	56	70	M8	1
50T16B	50	16	56	80	-	2
50T20B	50	20	56	80	-	2
50T25B	50	25	56	80	-	2
50T32B	50	32	56	80	-	2

Spare parts

Designation	Screw		Wrench		
...25T/50T 6A	SR M6x6 DIN916	-	L-W 3*		
...25T 8A/10A/12A	SR M8x6 DIN916	-	L-W 4*		
...50T 8A/10A/12A	SR M8x6 DIN916	-	L-W 4*		
...40T 6A	-	SR M6x10 DIN1835-B	L-W 3*		
...40T 8A/10A/12A	-	SR M8x10 DIN1835-B	L-W 4*		

*Marked: Optional, should be ordered separately

S 32 S - C T F P R - 16 -

1 2 3 4 5 6 7 8 9 10

1 Boring bar

S	Steel shank
A	Coolant through steel shank
C	Carbide shank
E	Coolant through carbide shank
X	Special

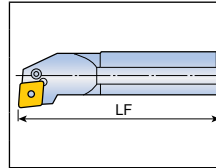
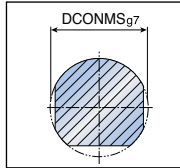

K	125	U	350
M	150	V	400
Q	180	W	450
R	200	Y	500
S	250	X	Special
T	300		

4 Clamping system



5 Insert shape

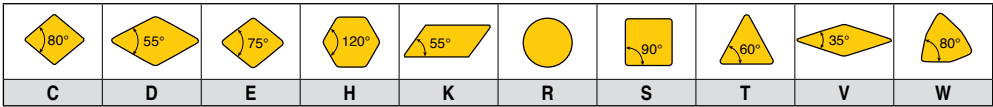

6 Approach angle

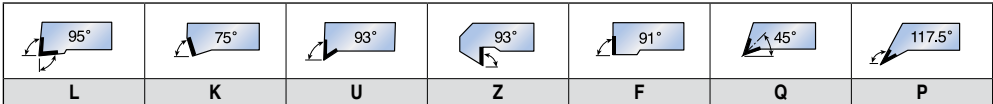

7 Insert clearance angle

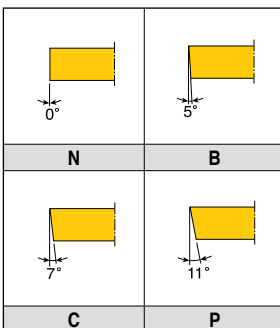

8 Hand of tool

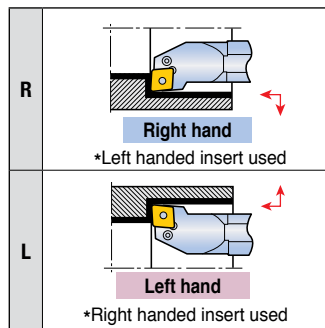

9 Cutting edge length

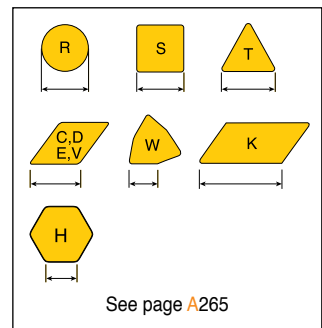

10 Manufacturer's type designation

Unique to manufacturer

Top clamp type boring bars

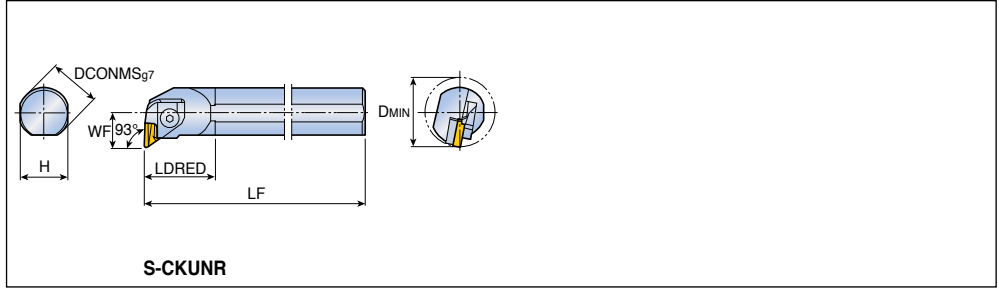

Approach angle	Designation	Dimension (mm)						Insert
		DCONMS	H	LF	LDRED	WF	DMIN	
93°	S32T CKUNR/L 16	32	30	300	45	22	44	KNUX 1604...R/L A282
	S40T CKUNR/L 16	40	37	300	55	27	54	
	S40V CKUNR/L 16	40	37	400	55	27	54	
	S50U CKUNR/L 16	50	47	350	60	35	67.2	

Spare parts

Designation	Clamp	Screw	Clamp spring	Shim	Shim screw	Pin & spring	Wrench	
...16	CL 16KR/L	CLS 16K	KSP 90	CSK 1604R/L	FH M3x0.5 x10	KSP 48 KP 48S	L-W 4	

Top clamp type boring bars

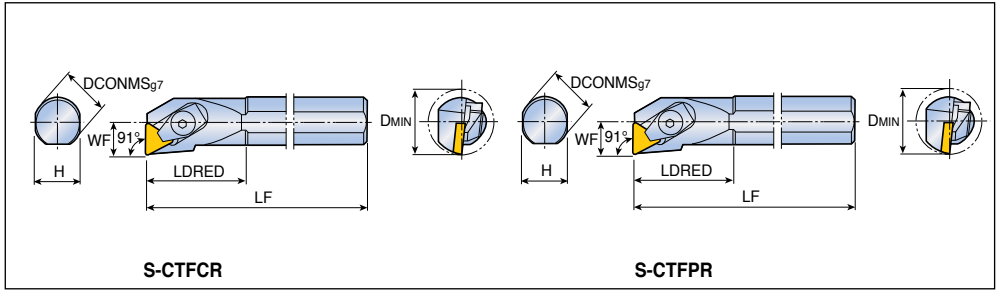

Approach angle	Designation	Dimension (mm)						Insert
		DCONMS	H	LF	LDRED	WF	DMIN	
91°	S10K CTFCR/L 06	10	9	125	25	6.5	12	TCGR 0601...
91°	S10K CTFPR/L 06	10	9	125	25	6.5	12	TP...R 0601...
	S12M CTFPR/L 06	12	11	150	30	9	16	TP...R, TP...N 0902... A327-A329, A363, A364
	S12M CTFPR/L 09	12	11	150	25	9	16	
	S16R CTFPR/L 09	16	15	200	25	11	20	TP...R, TP...N 1103...
	S12M CTFPR/L 11	12	11	150	30	9	16	TP...R, TP...N 1603...
	S16R CTFPR/L 11	16	15	200	30	11	20	
	S20S CTFPR/L 11	20	18	250	35	13	25	TP...R, TP...N 1603...
	S16R CTFPR/L 16	16	15	200	40	11	20	
	S20S CTFPR/L 16	20	18	250	50	13	25	TPMR, TP...N 2204...
	S25T CTFPR/L 16	25	23	300	40	17	32	
	S32T CTFPR/L 16	32	30	300	45	22	40	TPMR, TP...N 2204...
	S40T CTFPR/L 16	40	37	300	41.5	27	50	
	S50U CTFPR/L 16	50	47	350	56	35	63	TPMR, TP...N 2204...
	S40T CTFPR/L 22	40	37	300	41.5	27	50	
	S50U CTFPR/L 22	50	47	350	56	35	63	

Spare parts

Designation	Clamp			Screw	Snap ring	Shim	Shim pin	Wrench
...06	CL 1.25	-	-	CLS 1.25	CSR 1.25	-	-	L-W 1.5
...09	CL 1.25	-	-	CLS 1.25	CSR 1.25	-	-	L-W 1.5
...11	-	CL 2C	-	CLS 2C	CSR 2C	-	-	L-W 2.5
S16R...16	-	CL 3C	-	CLS 3C	CSR 2	-	-	L-W 3
S20S...16	-	CL 3C	-	CLS 3C	CSR 2	-	-	L-W 3
S25T...16	-	-	CL 3	CLS 3S	WSR 4	-	-	L-W 3
...16	-	-	CL 3	CLS 3	WSR 4	CST 32	CSP 3	L-W 3
...22	-	-	CL 4	CLS 4	CSR 4	CST 43	CSP 16K	L-W 4

Hook lever type boring bars

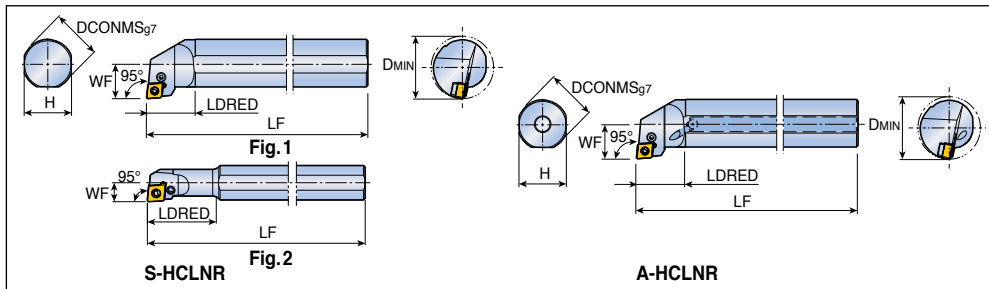

Approach angle	Designation	Dimension (mm)						Fig.	Insert
		DCONMS	H	LF	LDRED	WF	DMIN		
 95°	S16Q HCLNR/L 0904	16	15	180	25	11	20	1	CN... 0904... A266, A268-A273
	S20Q HCLNR/L 0904	20	18	180	28	13	25	1	
	S20Q HCLNR/L 0904-D20	20	18	180	40	11	20	2	
	S25R HCLNR/L 0904	25	23	200	31	17	32	1	
	S32S HCLNR/L 0904	32	30	250	31	22	40	1	
	S40T HCLNR/L 0904	40	37	300	55	27	50	1	
 95°	A16Q HCLNR/L 0904	16	15	180	25	11	20	CN... 0904... 	
	A20Q HCLNR/L 0904	20	18	180	28	13	25		
	A25R HCLNR/L 0904	25	23	200	31	17	32		
	A32S HCLNR/L 0904	32	30	250	31	22	40		

Spare parts

Designation	Lever	Screw	Shim	Shim pin	Snap ring	Wrench		
S ...0904								
S ...0904...D	LCL 09B-NX	LCS 3B	-	-	LSR 3B	L-W 2		
S32S...0904	LCL 09-NX	LCS 3	LSC 32	LSP 3A	-	L-W 2.5		
S40T ...0904	LCL 09-NX	LCS 3	LSC 32	LSP 3A	-	L-W 2.5		
A ...0904	LCL 09B-NX	LCS 3B	-	-	LSR 3B	L-W 2		
A32S...0904	LCL 09-NX	LCS 3	LSC 32	LSP 3A	-	L-W 2.5		

Hook lever type boring bars

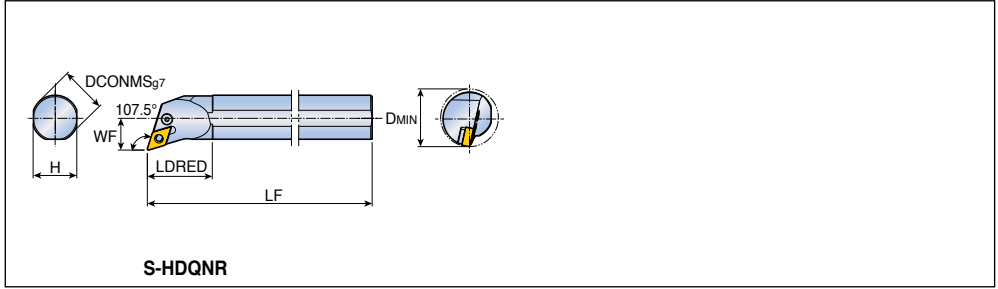

Approach angle	Designation	Dimension (mm)							Insert
		DCONMS	H	LF	LDRED	WF	DMIN		
107.5°	S32S HDQNR/L1305	32	30	250	45	22	40	DN... 1305... A276-A281	

Spare parts

Designation	Lever	Screw	Shim	Shim pin	Wrench		
...1305	LCL 11-NX	LSC 4S	LSD 3.52B	LSP 4	L-W 3		

S-HDUNR/L A-HDUNR/L



Hook lever type boring bars

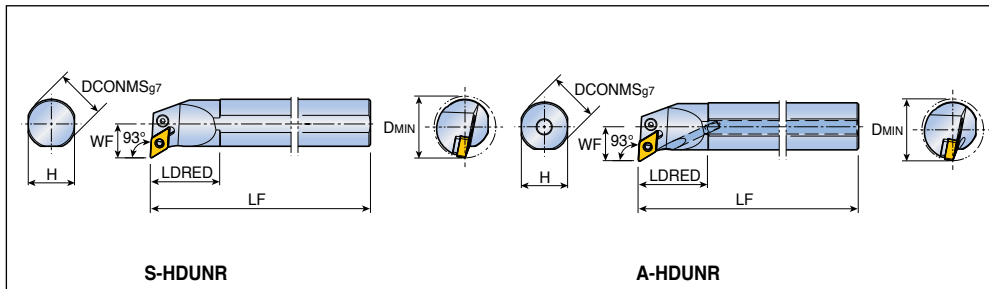

Approach angle	Designation	Dimension (mm)						Insert
		DCONMS	H	LF	LDRED	WF	DMIN	
93°	S32S HDUNR/L1305	32	30	250	45	22	40	DN... 1305... RHINO TURN A276-A281
	S40T HDUNR/L1305	40	37	300	55	27	50	
93°	A32S HDUNR/L1305	32	30	250	45	22	40	
	A40T HDUNR/L1305	40	37	300	55	27	50	

Spare parts

Designation	Lever	Screw	Shim	Shim pin	Wrench			
...1305	LCL 11-NX	LCS 4S	LSD 3.52B	LSP 4	L-W 3			

S-HDZNR/L A-HDZNR/L



Hook lever type boring bars

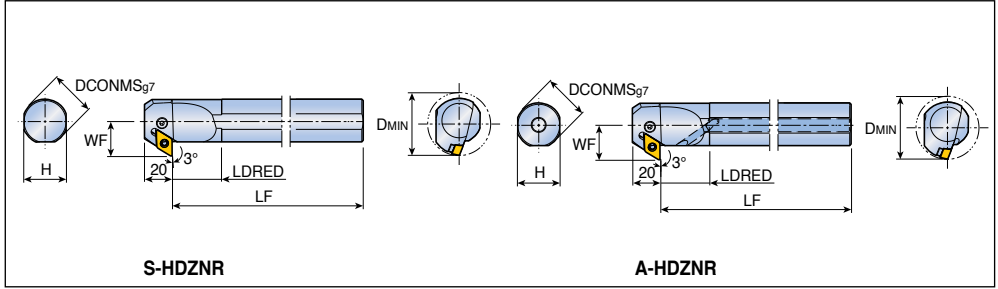

Approach angle	Designation	Dimension (mm)						Insert
		DCONMS	H	LF	LDRED	WF	DMIN	
93°	S32S HDZNR/L1305	32	30	250	35	25	45	DN... 1305... RHINO TURN A276-A281
	S40T HDZNR/L1305	40	37	300	40	29	50	
93°	A32S HDZNR/L1305	32	30	250	35	25	45	
	A40T HDZNR/L1305	40	37	300	40	29	50	

Spare parts

Designation	Lever	Screw	Shim	Shim pin	Wrench			
...1305	LCL 11-NX	LCS 4S	LSD 3.52B	LSP 4	L-W 3			

Hook lever type boring bars

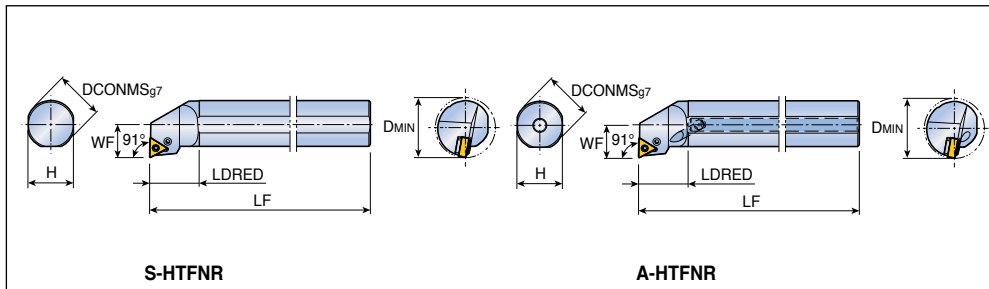

Approach angle	Designation	Dimension (mm)						Insert
		DCONMS	H	LF	LDRED	WF	DMIN	
91°	S16Q HTFNR/L 1304	16	15	180	25	11	20	TN... 1304... A291-A296
	S20Q HTFNR/L 1304	20	18	180	28	13	25	
	S25R HTFNR/L 1304	25	23	200	33	17	32	
	S32S HTFNR/L 1304	32	30	250	33	22	40	
91°	A16Q HTFNR/L 1304	16	15	180	25	11	20	
	A20Q HTFNR/L 1304	20	18	180	28	13	25	
	A25R HTFNR/L 1304	25	23	200	33	17	32	
	A32S HTFNR/L 1304	32	30	250	33	22	40	

Spare parts

Designation	Lever	Screw	Shim	Shim pin	Snap ring	Wrench		
...1304								
LCL 08B-NX	LCL 08B-NX	LCS 3B	-	-	LSR 3B	L-W 2		
...32S...1304	LCL 08-NX	LCS 3-NX	LST 2.51.8B	LSP 3B	-	L-W 2.5		

S-HTUNR/L A-HTUNR/L



Hook lever type boring bars

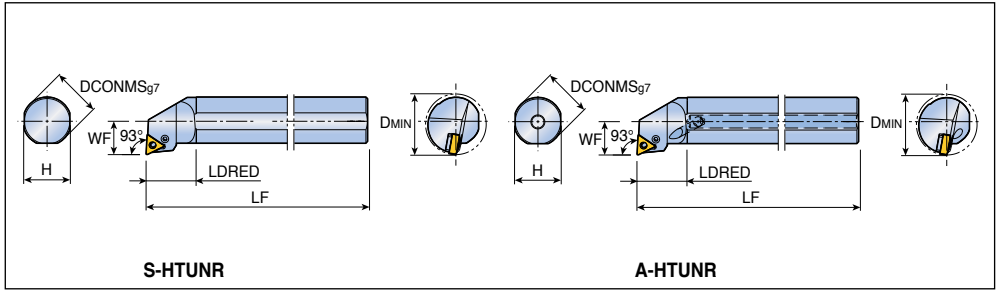

Approach angle	Designation	Dimension (mm)						Insert
		DCONMS	H	LF	LDRED	WF	DMIN	
93°	S16Q HTUNR/L 1304	16	15	180	25	11	20	TN... 1304... A291-A296
	S20Q HTUNR/L 1304	20	18	180	28	13	25	
	S25R HTUNR/L 1304	25	23	200	33	17	32	
	S32S HTUNR/L 1304	32	30	250	33	22	40	
93°	A16Q HTUNR/L 1304	16	15	180	25	11	20	
	A20Q HTUNR/L 1304	20	18	180	28	13	25	
	A25R HTUNR/L 1304	25	23	200	33	17	32	
	A32S HTUNR/L 1304	32	30	250	33	22	40	

Spare parts

Designation	Lever	Screw	Shim	Shim pin	Snap ring	Wrench		
...1304	LCL 08B-NX	LCS 3B	-	-	LSR 3B	L-W 2		
...32S...1304	LCL 08-NX	LCS 3-NX	LST 2.51.8B	LSP 3B	-	L-W 2.5		

Hook lever type boring bars

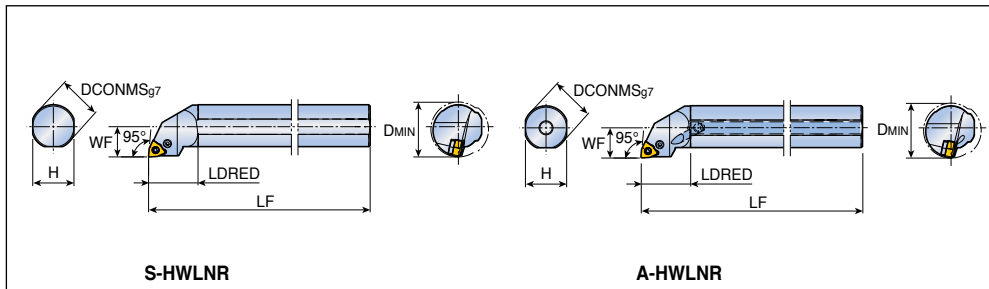

Approach angle	Designation	Dimension (mm)						Insert
		DCONMS	H	LF	LDRED	WF	DMIN	
95°	S16Q HWLN/L 0604	16	15	180	30	11	20	WN...X 0604... A303, A304
	S20Q HWLN/L 0604	20	18	180	33	13	25	
	S25R HWLN/L 0604	25	23	200	36	17	32	
	S32S HWLN/L 0604	32	30	250	36	22	40	
95°	A16Q HWLN/L 0604	16	15	180	30	11	20	
	A20Q HWLN/L 0604	20	18	180	33	13	25	
	A25R HWLN/L 0604	25	23	200	36	17	32	
	A32S HWLN/L 0604	32	30	250	36	22	40	

Spare parts

Designation	Lever	Screw	Shim	Shim pin	Snap ring	Wrench		
...0604								
...0604	LCL 09B-NX	LCS 3B	-	-	LSR 3B	L-W 2		
...32S ...0604	LCL 09-NX	LCS 3	LSW 32	LSP 3A	-	L-W 2.5		

Lever lock type boring bars

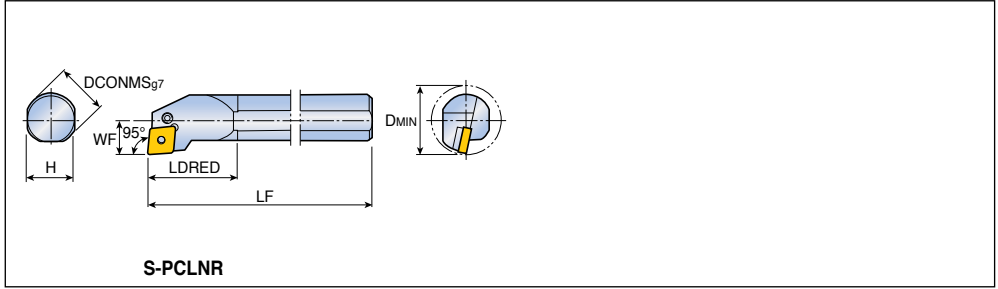

Approach angle	Designation	Dimension (mm)						Insert
		DCONMS	H	LF	LDRED	WF	DMIN	
95°	S25T PCLNR/L12	25	23	300	40	17	32	CN...1204... A266, A268-A273, A275, A341, A342, A353
	S32T PCLNR/L12	32	30	300	45	22	40	
	S40T PCLNR/L12	40	37	300	55	27	50	
	S50U PCLNR/L12	50	47	350	70	35	63	CN...1606... CN...1906...
	S50U PCLNR/L16	50	47	350	70	35	63	
	S50U PCLNR/L19	50	47	350	70	35	63	



Spare parts

Designation	Lever	Screw	Shim	Shim pin	Snap ring	Wrench		
S25T...12	LCL 4B	LCS 4B	-	-	LSR 4B	L-W 2.5		
S32 ...12	LCL 4	LCS 4S	LSC 42	LSP 4	-	L-W 3		
...12	LCL 4	LCS 4	LSC 42	LSP 4	-	L-W 3		
...16	LCL 5	LCS 5	LSC 53	LSP 5	-	L-W 3		
...19	LCL 6D	LCS 6	LSC 63	LSP 6	-	L-W 4		

S-PDUNR/L S-PDZNR/L

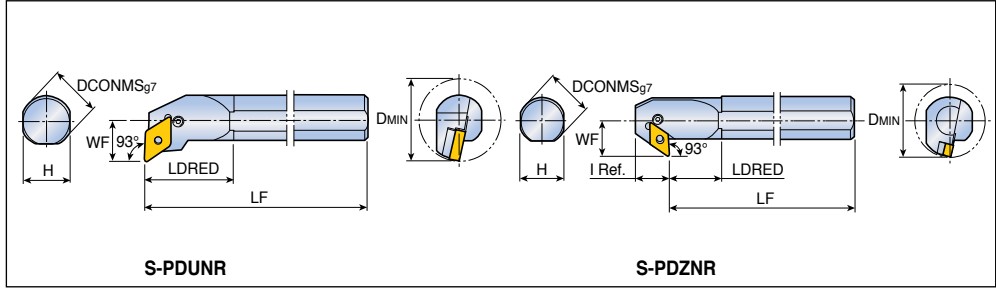
Lever lock type boring bars

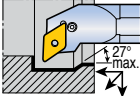

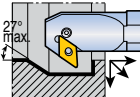
Approach angle	Designation	Dimension (mm)							Insert	
		DCONMS	H	LF	LDRED	WF	I	DMIN		
93° 	S32T PDUNR/L 15	32	30	300	45	22	-	40	DN...1506...  A276-A281, A343, A354	
	S40T PDUNR/L 15	40	37	300	55	27	-	50		
	S50U PDUNR/L 15	50	47	350	70	35	-	63		
	S32T PDUNR/L 15-A	32	30	300	35	22	-	40		DN...1504...
93°  For back boring	S32T PDZNR/L 15	32	30	300	30	25	26	45	DN...1506...	
	S40T PDZNR/L 15	40	37	300	35	29	26	50		
	S50U PDZNR/L 15	50	47	350	45	35	27	63		

Spare parts

Designation	Lever	Screw	Shim	Shim pin	Wrench			
								
S32T ...15	LCL 4A	LCS 4S	LSD 42	LSP 4	L-W 3			
S40T PDZ ...15	LCL 4A	LCS 4S	LSD 42	LSP 4	L-W 3			
...15	LCL 4A	LCS 4	LSD 42	LSP 4	L-W 3			
...15-A	LCL 4A	LCS 4S	LSD 42	LSP 4	L-W 3			

Lever lock type boring bars

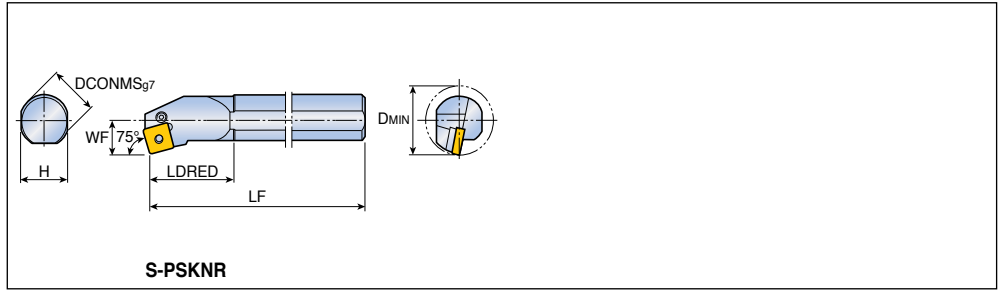

Approach angle	Designation	Dimension (mm)						Insert
		DCONMS	H	LF	LDRED	WF	DMIN	
75°	S25T PSKNR/L 12	25	23	300	33	17	32	SN...1204... A284-A290, A346, A347, A356
	S32T PSKNR/L 12	32	30	300	45	22	40	
	S40T PSKNR/L 12	40	37	300	41.5	27	50	
	S50U PSKNR/L 19	50	47	350	56	35	63	

Spare parts

Designation	Lever	Screw	Shim	Shim pin	Snap ring	Wrench		
S25T...12	LCL 4B	LCS 4B	-	-	LSR 4B	L-W 2.5		
S32T...12	LCL 4	LCS 4S	LSS 42	LSP 4	-	L-W 3		
S40T...12	LCL 4	LCS 4	LSS 42	LSP 4	-	L-W 3		
...19	LCL 6	LCS 6	LSS 63	LSP 6	-	L-W 4		

Lever lock type boring bars

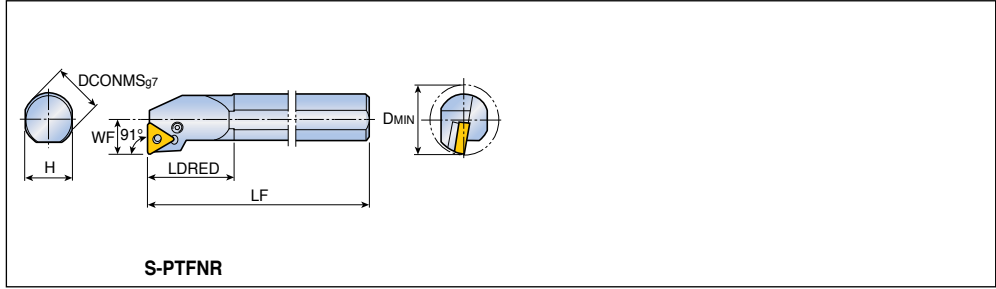

Approach angle	Designation	Dimension (mm)						Insert
		DCONMS	H	LF	LDRED	WF	DMIN	
91°	S20Q PTFNR/L11	20	18	180	40	13	25	TN... 1103...
	S25T PTFNR/L16	25	23	300	40	17	32	TN... 1604... A291-A296, A349, A357
	S32T PTFNR/L16	32	30	300	45	22	40	
	S40T PTFNR/L16	40	37	300	60	27	50	
	S50U PTFNR/L16	50	47	350	56	35	63	
	S40T PTFNR/L22	40	37	300	56	27	50	TN... 2204...
	S50U PTFNR/L22	50	47	350	56	35	63	

Spare parts

Designation	Lever	Screw	Shim	Shim pin	Snap ring	Wrench		
...11								
...11	LCL 2B	LCS 2B	-	-	LSR 2B	L-W 2		
S25T ...16	LCL 3BH	LCS 3B	-	-	LSR 3B	L-W 2		
...16	LCL 3	LCS 3	LST 31.8	LSP 3A	-	L-W 2.5		
... 22	LCL 4	LCS 4	LST 42	LSP 4	-	L-W 3		

Screw type boring bars

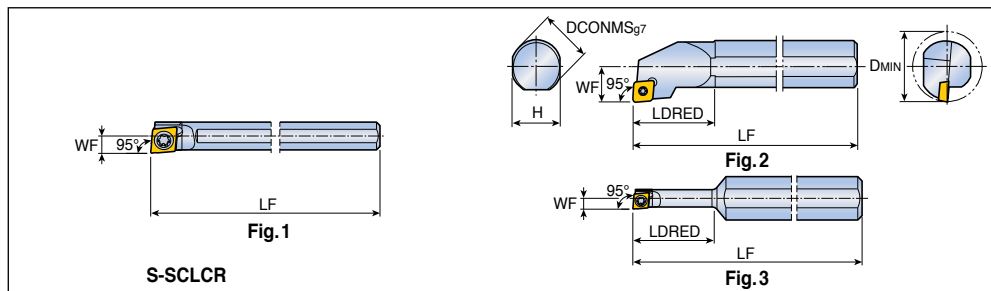

Approach angle	Designation	Dimension (mm)							Fig.	Insert
		DCONMS	H	LF	LDRED	WF	DMIN			
	S04F SCLCR/L 03-D05	4	3.75	80	-	2.5	5	1	CC...T 0301... A309-A312, A360	
	S05G SCLCR/L 03-D06	5	4.75	90	-	3	6	1		
	S10H SCLCR/L 03-D05	10	9	100	15	2.5	5	3		
	S06H SCLCR/L 04-D07	6	5.5	100	-	3.5	7	1	CC...T 0401...	
	S07J SCLCR/L 04-D08	7	6.5	110	-	4	8	1		
	S08K SCLCR/L 06	8	7	125	18	6	11	2	CC... 0602...	
	S10K SCLCR/L 06	10	9	125	20	7	13	2		
	S12M SCLCR/L 06	12	11	150	25	9	16	2		
	S16R SCLCR/L 06	16	15	200	30	11	20	2		
	S12M SCLCR/L 09	12	11	150	23	9	16	2	CC... 09T3...	
	S16R SCLCR/L 09	16	15	200	30	11	20	2		
	S20S SCLCR/L 09	20	18	250	32	13	25	2		
	S25T SCLCR/L 12	25	23	300	42	17	32	2	CC... 1204...	
	S32T SCLCR/L 12	32	30	300	45	22	40	2		
	S40T SCLCR/L 12	40	37	300	55	27	50	2		

• L-hand insert for R-hand toolholder, R-hand insert for L-hand toolholder

Spare parts





Designation	Screw	Shim	Shim screw	Wrench			
...03	TS 16031I	-	-	T 6	-		
...04	TS 20038I/HG-P	-	-	T 6P	-		
S...K ...06	SO 25050I	-	-	T 7	-		
...06	SO 25065I	-	-	T 7	-		
...09	SO 35080I	-	-	T 15	-		
S25T...12	SO 45100I	-	-	T 20	-		
...12	SO 45130I	SSC 43N	SO 60105S	T 20	L-W 5		

S-SCLNR/L A-SCLNR/L

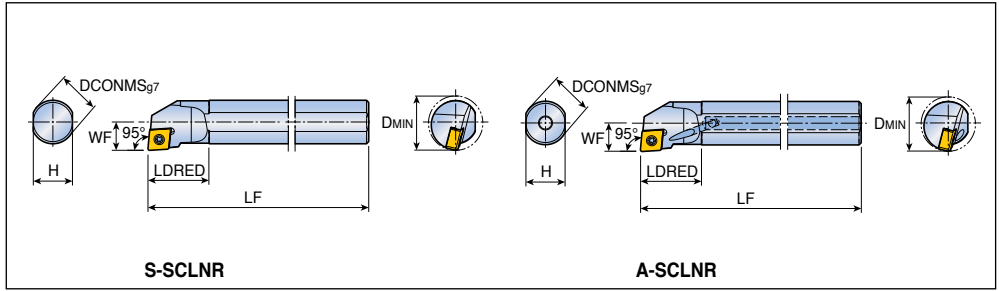

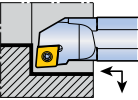

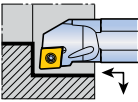
Screw type boring bars



Approach angle	Designation	Dimension (mm)						Insert
		DCONMS	H	LF	LDRED	WF	DMIN	
 95°	S16Q SCLNR/L 0904	16	15	180	25	11	20	CN... 0904...  A266, A268-A273
	S20Q SCLNR/L 0904	20	18	180	28	13	25	
	S20Q SCLNR/L 0904-D20	20	18	180	40	11	20	
 95°	A12M SCLNR/L 0703	12	11	150	21.5	9	16	CNMX 0703...  A275
	A16Q SCLNR/L 0703	16	15	180	24.5	11	20	
	A16Q SCLNR/L 0904	16	15	180	25	11	20	CN... 0904...  A266, A268-A273
	A20Q SCLNR/L 0904	20	18	180	28	13	25	

Spare parts

Designation	Screw	Wrench				
	...0703	 TS 25D060/HG-P	 T 7P			
...0904	TS 350831/HG	T 10				

Screw type boring bars

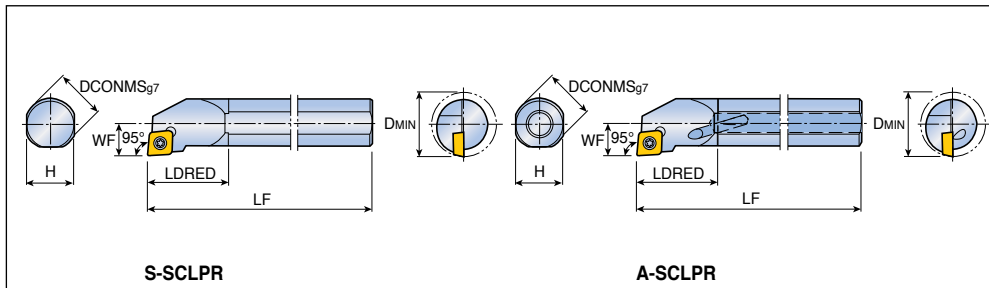

Approach angle	Designation	Dimension (mm)						Insert
		DCONMS	H	LF	LDRED	WF	DMIN	
 95°	S10K SCLPR/L 08	10	9	125	20	6	12	CP...T 0802... CP...T 0903... A313
	S12M SCLPR/L 08	12	11	150	23	8	16	
	S16R SCLPR/L 09	16	15	200	30	10	20	
	S20S SCLPR/L 09	20	18	250	32	12.5	25	
 95°	A08H SCLPR/L 06	8	7	100	15	6	11	CP...T 0602...
	A10K SCLPR/L 06	10	9	125	15	7	13	
	A12M SCLPR/L 0903	12	11	150	19	9	16	CP...T 0903...
	A16Q SCLPR/L 0903	16	15	180	20	11	20	
	A20R SCLPR/L 0903	20	18	200	22	13	25	CP...T 09T3...
	A12M SCLPR/L 09T3	12	11	150	19	9	16	
	A16Q SCLPR/L 09T3	16	15	180	24.5	11	20	
	A20R SCLPR/L 09T3	20	18	200	22	13	25	

• L-hand insert for R-hand toolholder, R-hand insert for L-hand toolholder

Spare parts

Designation	Screw	Wrench					
...06	SO 25050I	T 7					
...08	SO 30055I	T 9					
...09	SO 35080I	T 15					
...0903, 09T3	TS 35070I/HG	T 15					

E-SCLPR/L A-SDLNR/L





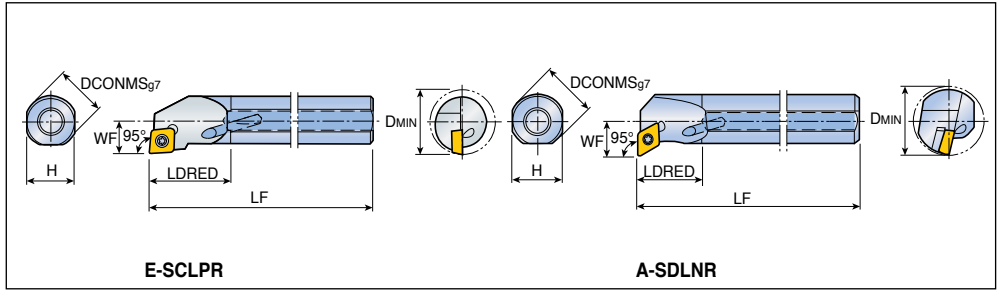

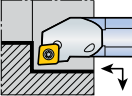
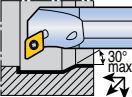
Screw type boring bars



Approach angle	Designation	Dimension (mm)						Insert
		DCONMS	H	LF	LDRED	WF	DMIN	
95° 	✓ E08K SCLPR/L 06	8	7	125	15	6	11	CP...T 0602... A313
	✓ E10K SCLPR/L 06	10	9	125	15	7	13	
	✓ E12M SCLPR/L 0903	12	11	150	19	9	16	CP...T 0903...
	✓ E16R SCLPR/L 0903	16	15	200	22	11	20	
	✓ E12M SCLPR/L 09T3	12	11	150	19	9	16	CP...T 09T3...
	✓ E16R SCLPR/L 09T3	16	15	200	22	11	20	
95° 	A20S SDLNR/L 11	20	18	250	28	13	24	DN...1104... A276-A278, A280
	A25T SDLNR/L 11	25	23	300	42	17	31	

• ✓ Marked: Designates carbide shank • L-hand insert for R-hand toolholder, R-hand insert for L-hand toolholder





Spare parts

Designation	Screw	Shim	Shim screw	Wrench		Seal		
...06	SO 25050I	-	-		T 7	-	-	
...09	TS 35070I/HG	-	-		T 15	-	-	
A20S...11	SO 35120I	-	-		T 10	-	PL 20	
A25T...11	SO 35120I	SSD 32	SO 50090S		T 10	L-W 3.5	PL 25	

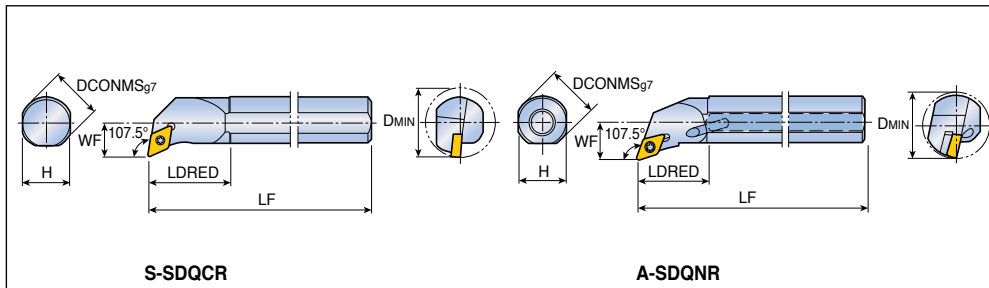
S-SDQCR/L A-SDQNR/L

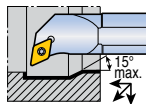

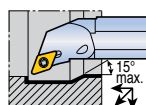



Screw type boring bars



Approach angle	Designation	Dimension (mm)						Insert
		DCONMS	H	LF	LDRED	WF	DMIN	
107.5° 	S10K SDQCR/L 07	10	9	125	20	7	13	DC... 0702...  A314-A317, A361
	S12M SDQCR/L 07	12	11	150	22	9	16	
	S16R SDQCR/L 07	16	15	200	27	11	20	
	S20S SDQCR/L 11	20	18	250	40	13	25	
	S25T SDQCR/L 11	25	23	300	50	17	32	
107.5° 	A16S SDQNR/L 11	16	15	250	30	13	23	DN... 1104...  A276-A278, A280
	A20S SDQNR/L 11	20	18	250	31	15	27	
	A25T SDQNR/L 11	25	23	300	35	19	33	
	A32T SDQNR/L 11	32	30	300	44	26	44	

• L-hand insert for R-hand toolholder, R-hand insert for L-hand toolholder

Spare parts

Designation	Screw	Shim	Shim screw	Wrench		Seal		
								
S10 ...07	SO 25050I	-	-	T 7	-	-		
S ...07	SO 25065I	-	-	T 7	-	-		
S ...11	SO 35080I	-	-	T 15	-	-		
A16S...11	SO 35120I	-	-	T 10	-	PL 16		
A20S...11	SO 35120I	SSD 32	SO 50090S	T 10	L-W 3.5	PL 20		
A25T...11	SO 35120I	SSD 32	SO 50090S	T 10	L-W 3.5	PL 25		
A32T...11	SO 35120I	SSD 32	SO 50090S	T 10	L-W 3.5	PL 32		

S-SDUCR/L A-SDUNR/L





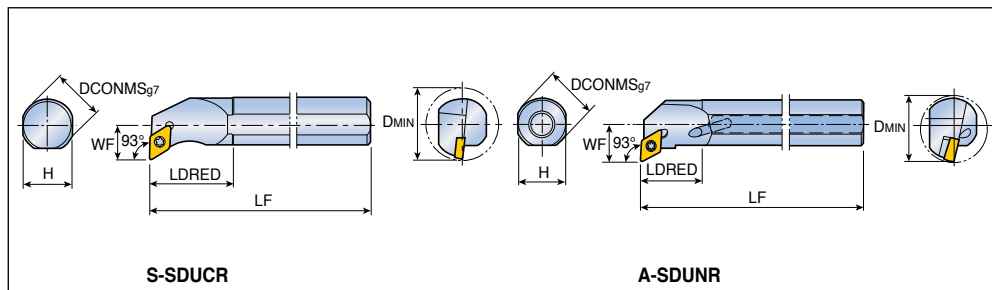

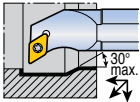
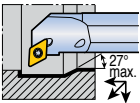

Screw type boring bars



Approach angle	Designation	Dimension (mm)						Insert
		DCONMS	H	LF	LDRED	WF	DMIN	
 93°	S10K SDUCR/L 07	10	9	125	20	7	13	DC... 0702... A314-A317, A361
	S12M SDUCR/L 07	12	11	150	23	9	16	
	S16R SDUCR/L 07	16	15	200	30	11	20	DC... 11T3... A276, A277, A280
	S16R SDUCR/L 11	16	15	200	27	11	20	
	S20S SDUCR/L 11	20	18	250	32	13	25	
	S25T SDUCR/L 11	25	23	300	42	17	32	
	S32T SDUCR/L 11	32	30	300	55	22	40	
 93°	A12M SDUNR/L 0803	12	11	150	21.5	9	16	DN...X 0803... RHINO TURN A281
	A16Q SDUNR/L 0803	16	15	180	24.5	11	20	
	A20S SDUNR/L 11	20	18	250	30	15	27	DN... 1104... A276, A277, A280
	A25T SDUNR/L 11	25	23	300	30	19	33	
	A32T SDUNR/L 11	32	30	300	44	26	44	

• L-hand insert for R-hand toolholder, R-hand insert for L-hand toolholder

Spare parts

Designation	Screw	Shim	Shim screw	Wrench		Seal		
								
S ...07	SO 250651	-	-	T 7	-	-		
S ...11	SO 350801	-	-	T 15	-	-		
A20S...11	SO 351201	-	-	T 10	-	PL 20		
A25T ...11	SO 351201	SSD 32	SO 50090S	T 10	L-W 3.5	PL 25		
A32T ...11	SO 351201	SSD 32	SO 50090S	T 10	L-W 3.5	PL 32		
...0803	TS 25D060/HG-P	-	-	T 7P	-	-		

Screw type back boring bars

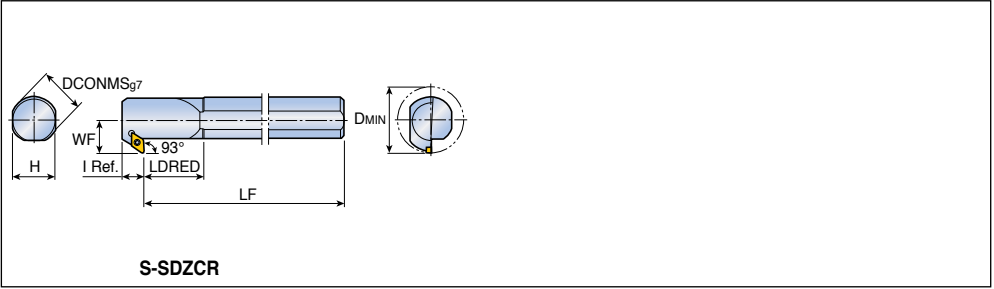

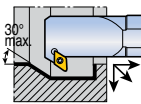
Approach angle	Designation	Dimension (mm)							Insert
		DCONMS	H	LF	LDRED	WF	I	DMIN	
93°	S16R SDZCR/L 07	16	15	200	23	13	12	22	DC... 0702... A314-A317, A361 DC... 11T3...
	S20S SDZCR/L 07	20	18	250	28	15	12	30	
	S25T SDZCR/L 07	25	23	300	33	18	12	33	
	S20S SDZCR/L 11	20	18	250	24	15	16	27	
	S32T SDZCR/L 11	32	30	300	34	22	16	40	
 For back boring									

• L-hand insert for R-hand toolholder, R-hand insert for L-hand toolholder

Spare parts

Designation	Screw	Shim	Shim screw	Wrench				
...07	SO 25065I	-	-	T 7	-			
S20S...11	SO 35080I	-	-	T 15	-			
S32T...11	SO 35124I	SSD 32	SO 50090S	T 15	L-W 3.5			

S-STFCR/L C-STFCR/L



Screw type boring bars

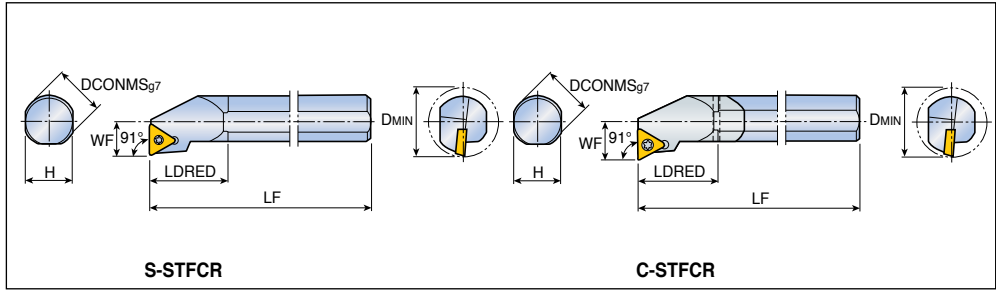

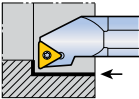
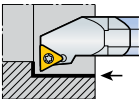
Approach angle	Designation	Dimension (mm)							Insert
		DCONMS	H	LF	LDRED	WF	DMIN		
91° 	S06H STFCR/L 06T1	6	5.4	100	12	4.5	8	TC...T 06T1...	
	S08K STFCR/L 09	8	7	125	20	6	11	TC... 0902... A324, A325, A363, A364	
	S10K STFCR/L 09	10	9	125	22.5	7	13		
	S12M STFCR/L 09	12	11	150	30	9	16		
	S16R STFCR/L 09	16	15	200	35	11	20		
	S12M STFCR/L 11	12	11	150	25	9	16	TC... 1102...	
	S16R STFCR/L 11	16	15	200	35	11	20		
	S20S STFCR/L 11	20	18	250	36	13	25		
	S20S STFCR/L 16	20	18	250	36	13	25	TC... 16T3...	
	S25T STFCR/L 16	25	23	300	49	17	32		
	S32T STFCR/L 16	32	30	300	45	22	40		
	S40T STFCR/L 16	40	37	300	60	27	50		
91° 	✓ C10K STFCR/L 09	10	9	125	15	7	13	TC... 0902...	
	✓ C10K STFCR/L 11	10	9	125	15	7	13	TC... 1102...	
	✓ C12M STFCR/L 11	12	11	150	20	9	16		
	✓ C16R STFCR/L 11	16	15	200	25	11	20		

• ✓ Marked: Designates carbide shank • L-hand insert for R-hand toolholder, R-hand insert for L-hand toolholder



Spare parts

Designation	Screw	Shim	Shim screw	Wrench				
...06T1	TS 20038I	-	-	T 6	-			
S08K...09	TS 22046I	-	-	T 7	-			
...09	SO 22050I	-	-	T 7	-			
...11	SO 25065I	-	-	T 7	-			
C10K...11	SO 25050I	-	-	T 7	-			
S20S...16	SO 35080I	-	-	T 15	-			
S25T...16	SO 35080I	-	-	T 15	-			
S32T...16	SO 35124I	SST 32	SO 50090S	T 15	L-W 3.5			
S40T...16	SO 35124I	SST 32	SO 50090S	T 15	L-W 3.5			

S-STFPR/L A-STFPR/L

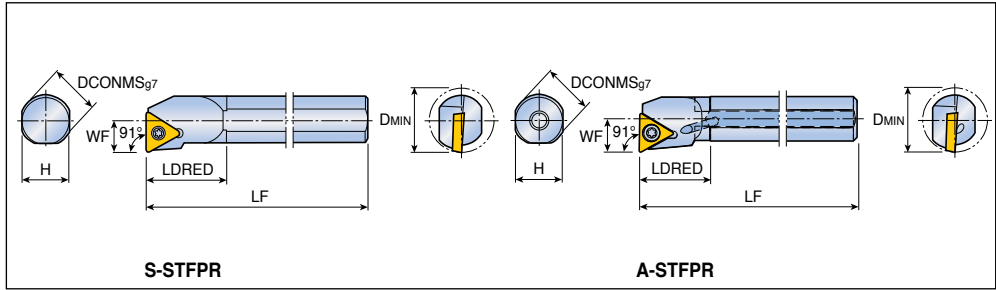

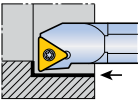
Screw type boring bars

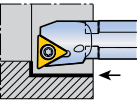

Approach angle	Designation	Dimension (mm)						Insert
		DCONMS	H	LF	LDRED	WF	DMIN	
 91°	S08K STFPR/L 09-X01	8	7	125	15	6	11	TPGX 0902... 
	S08K STFPR/L 09	8	7	125	14	6	11	TP...T 0902... A326-A328,
	S10K STFPR/L 11	10	9	125	25	6	12	TP...T 1103... A363
	S12M STFPR/L 11	12	11	150	30	8	16	
	S16R STFPR/L 11	16	15	200	35	10	20	
	S16N STFPR/L 16	16	15	160	30	10	20	TP...T 1604...
	S20S STFPR/L 16	20	18	250	36	12.5	25	TPMT 1103...
 91°	A08H STFPR/L 09	8	7	100	16.7	6	11	TP...T 0902...
	A10K STFPR/L 1102	10	9	125	16.4	7	13	TP...T 1102...
	A12M STFPR/L 1102	12	11	150	19	9	16	
	A16Q STFPR/L 1102	16	15	180	20	11	20	
	A12M STFPR/L 1103	12	11	150	19	9	16	TP...T 1103...
	A16Q STFPR/L 1103	16	15	180	20.5	11	20	TP...T 1103...
	A20R STFPR/L 16T3	20	18	200	26	13	25	TP...T 16T3...

- TPGX type inserts are available with alternate screw. (TPGX 1103 → SO 300811)
- L-hand insert for R-hand toolholder, R-hand insert for L-hand toolholder

Spare parts

Designation	Screw	Wrench				
...09-X01	 SO 25055I-MO	 T 8				
...09	TS 22046I	T 7				
S10 ...11	SO 30055I	T 9				
...11	SO 30100I	T 9				
S16R ...11	SO 30040I	T 9				
...1102	SO 25050I	T 7				
...1103	SO 30100I	T 9				
...16T3	TS 35070I/HG	T 15				
...16	SO 35124I	T 15				

C-STFPR/L E-STFPR/L



Screw type boring bars

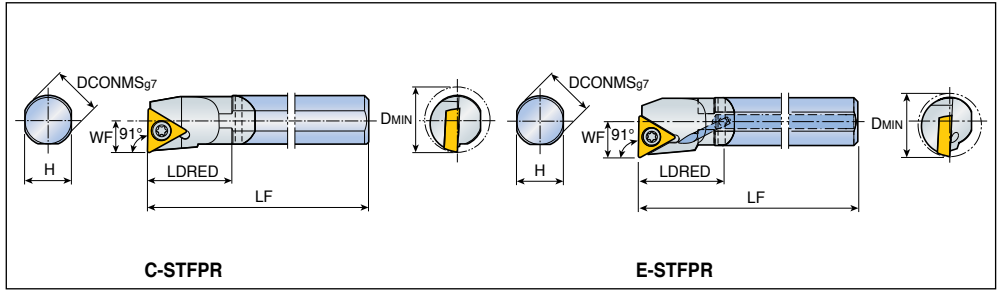

Approach angle	Designation	Dimension (mm)						Insert
		DCONMS	H	LF	LDRED	WF	DMIN	
91°	✓ C10K STFPR/L 11	10	9	125	15	6	12	TPGT 1103...
	✓ C12M STFPR/L 11	12	11	150	20	8	16	TPMT 1103... A326-A328, A363
91°	✓ E08K STFPR/L 09	8	7	125	15	6	11	TP...T 0902...
	✓ E10K STFPR/L 1102	10	9	125	15	7	13	TP...T 1102...
	✓ E12M STFPR/L 1102	12	11	150	18	9	16	
	✓ E16R STFPR/L 1102	16	15	200	21.5	11	20	
	✓ E12M STFPR/L 1103	12	11	150	18	9	16	TP...T 1103...
	✓ E16R STFPR/L 1103	16	15	200	22	11	20	TPMT 1103...

• ✓ Marked: Designates carbide shank • L-hand insert for R-hand toolholder, R-hand insert for L-hand toolholder

Spare parts

Designation	Screw	Wrench					
...09	TS 22046I	T 7					
C10K ...11	SO 30055I	T 9					
C12M...11	SO 30100I	T 9					
...1102	SO 25050I	T 7					
...1103	SO 30100I	T 9					

S-STUBR/L C-STUBR/L



Screw type boring bars

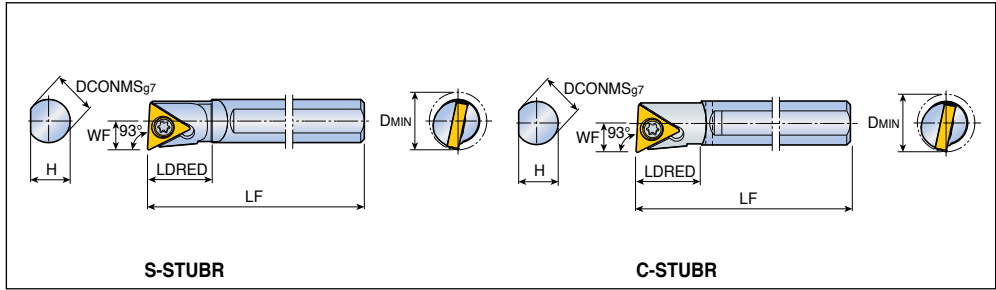

Approach angle	Designation	Dimension (mm)						Insert
		DCONMS	H	LF	LDRED	WF	DMIN	
93°	S06H STUBR/L 06-D08	6	5.5	100	8.6	4	8	TB...T 0601... A323
93°	✓ C06J STUBR/L 06-D08	6	5.5	110	8.6	4	8	

• ✓ Marked: Designates carbide shank • L-hand insert for R-hand toolholder, R-hand insert for L-hand toolholder

Spare parts

Designation	Screw	Wrench					
	...06-D08	 TS 20043I/HG-P	 T 6P				

S-STUNR/L A-STUNR/L



Screw type boring bars

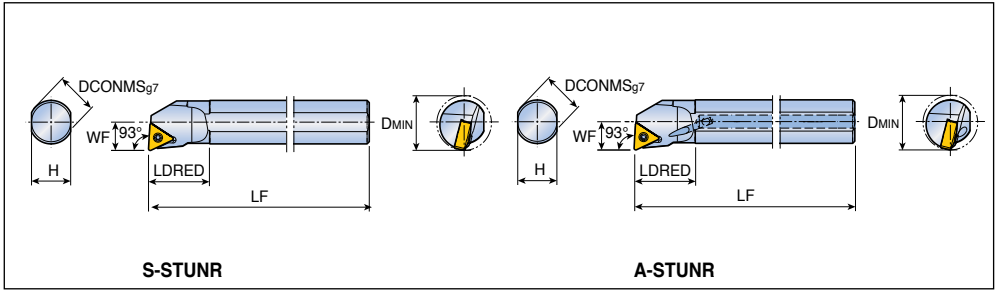

Approach angle	Designation	Dimension (mm)						Insert
		DCONMS	H	LF	LDRED	WF	DMIN	
93°	S16Q STUNR/L 1304	16	15	180	25	11	20	TN... 1304... A291-A296
	S20Q STUNR/L 1304	20	18	180	28	13	25	
93°	A16Q STUNR/L 1304	16	15	180	25	11	20	
	A20Q STUNR/L 1304	20	18	180	28	13	25	

Spare parts

Designation	Screw	Wrench					
	...1304	TS 30080I/HG	T 9				

S-SVJBR/L S-SVJCR/L



Screw type boring bars

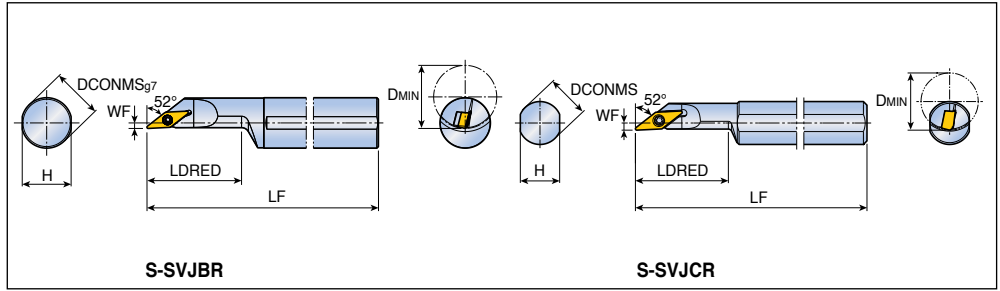

Approach angle	Designation	Dimension (mm)						Insert
		DCONMS	H	LF	LDRED	WF	DMIN	
52°	S20R SVJBR/L 11-D25	20	18	200	37.5	2	25	VB... 1103... A330, A365
	S25S SVJBR/L 11-D30	25	23	250	45	3.5	30	
	S32S SVJBR/L 16	32	30	250	60	3.5	40	
	S40T SVJBR/L 16	40	37	300	75	4.5	50	
52°	S12M SVJCR/L 08-D16	12	11	150	26	2	16	VC... 0802... A333
	S16Q SVJCR/L 08-D20	16	15	180	36	2	20	

• L-hand insert for R-hand toolholder, R-hand insert for L-hand toolholder

Spare parts

Designation	Screw	Shim	Shim screw	Wrench				
...08-...	TS 20038I/HG-P	-	-	T 6P	-			
...11-...	SO 25065I	-	-	T 7	-			
...16	SO 35124I	SSV32	SO 50090S	T15	L-W 3.5			

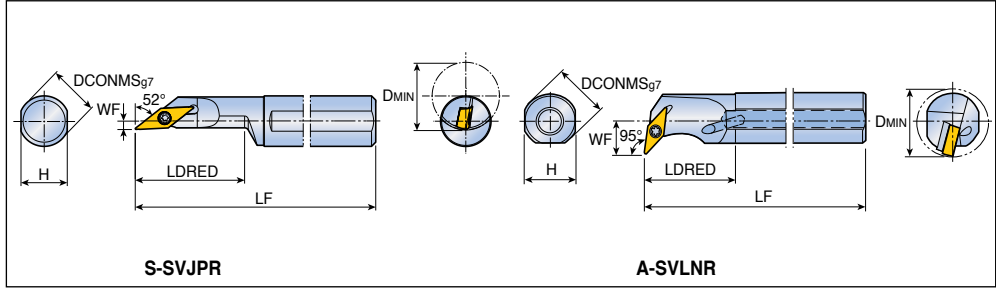

Screw type boring bars

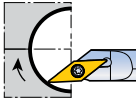
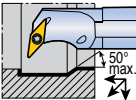

Approach angle	Designation	Dimension (mm)						Insert
		DCONMS	H	LF	LDRED	WF	DMIN	
52° 	S12M SVJPR/L 08-D16	12	11	150	26	2	16	VP...T 0802... A334
95° 	A25T SVLNR/L 1304	25	23	300	40	16	31	VN...X 1304... A299, A305
	A32T SVLNR/L 1304	32	30	300	45	20	38	YNMG 1304... RHINO TURN
	A25T SVLNR/L 13	25	23	300	40	16	31	VN... 13... A297, A298
	A32T SVLNR/L 13	32	30	300	45	20	38	

• L-hand insert for R-hand toolholder, R-hand insert for L-hand toolholder

Spare parts

Designation	Screw	Shim	Shim screw	Wrench		Seal		
								
S...08-D16	TS 20043I/HG-P	-	-	T 6P	-	-		
A..1304	TS 30120I/HG	SSVN 2.523	TS 5030062S	T 9	L-W 3.5	-		
A25T...13	SO 35120I	SSVN 2.523	TS 5035062S	T 10	L-W 3.5	PL 25		
A32T...13	SO 35120I	SSVN 2.523	TS 5035062S	T 10	L-W 3.5	PL 32		

S-SVPBR/L S-SVPCR/L





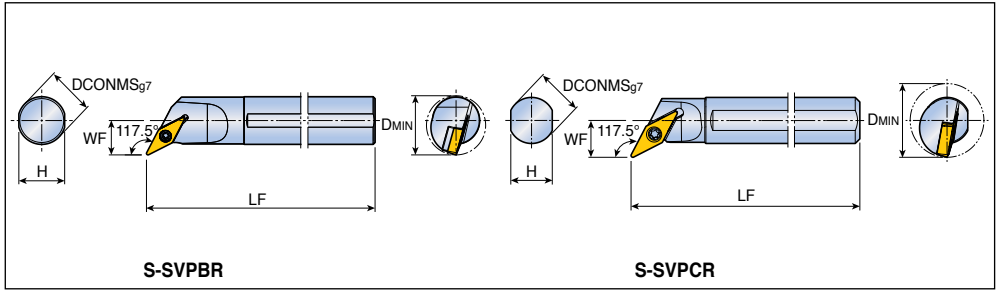

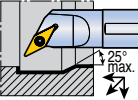
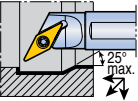
Screw type boring bars



Approach angle	Designation	Dimension (mm)						Insert
		DCONMS	H	LF	LDRED	WF	DMIN	
117.5° 	S16Q SVPBR/L 11-D22	16	15	180	35	13.5	22	VB... 1103... A330, A365
	S20R SVPBR/L 11-D26	20	18	200	41	15.5	26	
	S25S SVPBR/L 16	25	23	250	51	18	31	VB... 1604... A330, A331 A365
	S32S SVPBR/L 16	32	30	250	54	23	40	
117.5° 	S10K SVPCR/L 08-D16	10	9	125	16	8	16	VC...T 0802... VC...T 1103... A332, A333, A365
	S12M SVPCR/L 11-D20	12	11	150	19	10	20	

• L-hand insert for R-hand toolholder, R-hand insert for L-hand toolholder

Spare parts





Designation	Screw	Shim	Shim screw	Wrench				
								
...08-...	TS 20038I/HG-P	-	-	T 6P	-			
...11-...	SO 25065I	-	-	T 7	-			
...16	SO 35124I	SSV32	SO 50090S	T 15	L-W 3.5			

S-SVQBR/L S-SVQCR/L

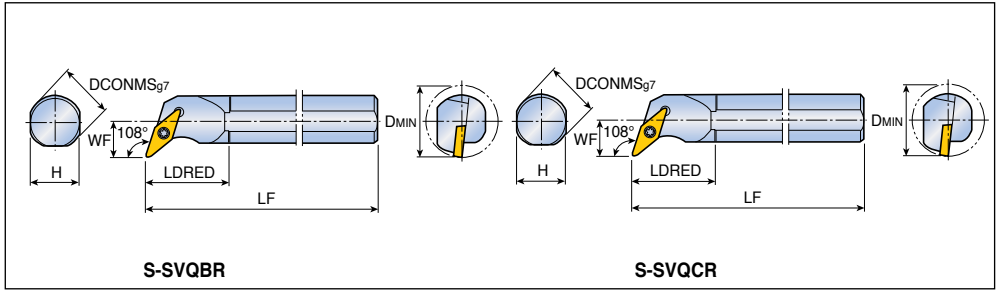

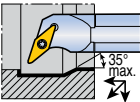

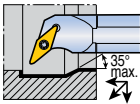
Screw type boring bars



Approach angle	Designation	Dimension (mm)						Insert	
		DCONMS	H	LF	LDRED	WF	DMIN		
108° 	S25T SVQBR/L 16	25	23	300	40	17	32	VB... 1604...  A330, A331, A365	
	S32T SVQBR/L 16	32	30	300	45	22	40		
	S40T SVQBR/L 16	40	37	300	41.5	27	50		
108° 	S32T SVQCR/L 16	32	30	300	45	22	40	VC...T 1604...  A332, A333, A365	
	S40T SVQCR/L 16	40	37	300	55	27	50		

• L-hand insert for R-hand toolholder, R-hand insert for L-hand toolholder

Spare parts

Designation	Screw	Shim	Shim screw	Wrench			
							
S25T...16	SO 35080I	-	-	T 15	-		
...16	SO 35124I	SSV 32	SO 50090S	T 15	L-W 3.5		

Screw type boring bars

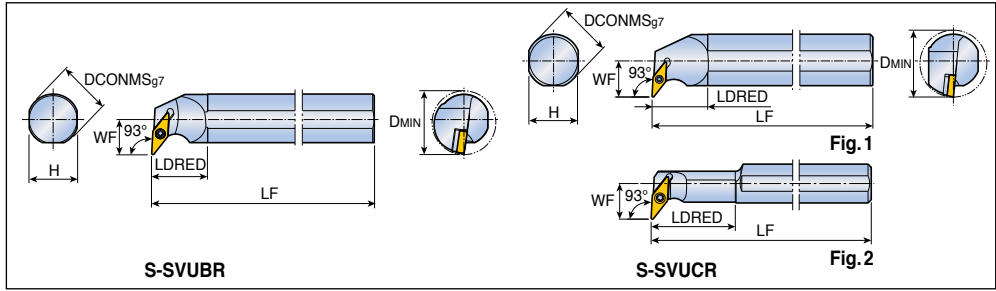

Approach angle	Designation	Dimension (mm)						Fig.	Insert
		DCONMS	H	LF	LDRED	WF	DMIN		
93°	S32T SVUBR/L 16	32	30	300	45	22	40	VB... 1604... A330, A331, A365	
	S40T SVUBR/L 16	40	37	300	55	27	50		
93°	S12M SVUCR/L 08-D16	12	11	150	26	11	16	2	VC...T 0802...
	S16Q SVUCR/L 11-D20	16	15	180	32	15.5	20	2	VC...T 1103... A332, A333, A365
	S20R SVUCR/L 11-D25	20	18	200	40	17.5	25	2	VC...T 1604... A365
	S32T SVUCR/L 16	32	30	300	35	22	40	1	
	S40T SVUCR/L 16	40	37	300	41.5	27	50	1	

• L-hand insert for R-hand toolholder, R-hand insert for L-hand toolholder

Spare parts

Designation	Screw	Shim	Shim screw	Wrench			
...08-...	TS 20038I/HG-P	-	-	T 6P	-		
...11-...	SO 25065I	-	-	T 7	-		
...16	SO 35124I	SSV 32	SO 50090S	T 15	L-W 3.5		

S-SWLNLR/L A-SWLNLR/L



Screw type boring bars

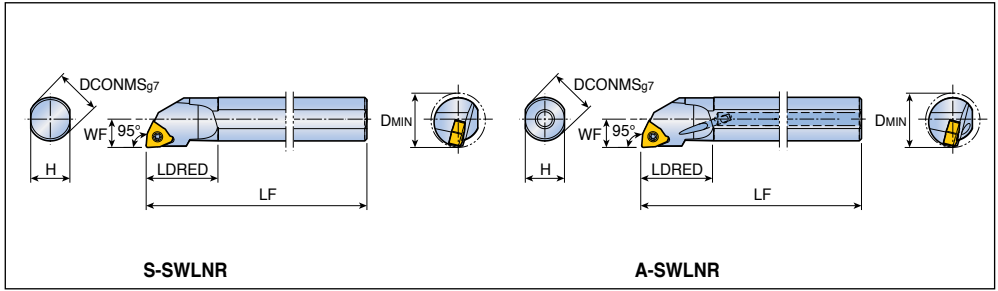

Approach angle	Designation	Dimension (mm)						Insert
		DCONMS	H	LF	LDRED	WF	DMIN	
95°	S16Q SWLNLR/L 0604	16	15	180	30	11	20	WN...X 0604... RHINO TURN A303, A304
	S20Q SWLNLR/L 0604	20	18	180	33	13	25	
95°	A12M SWLNLR/L 0403	12	11	150	21.5	9	16	WNMX 0403...
	A16Q SWLNLR/L 0403	16	15	180	24.5	11	20	RHINO TURN
	A16Q SWLNLR/L 0604	16	15	180	30	11	20	WNMX 0604..
	A20Q SWLNLR/L 0604	20	18	180	33	13	25	RHINO TURN

Spare parts

Designation	Screw	Wrench					
...0604	TS 350831/HG	T 10					
...0403	TS 25D060/HG-P	T 7P					

Screw type boring bars

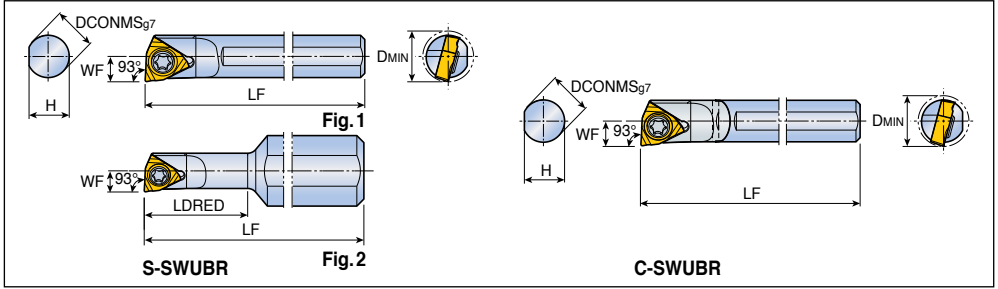

Approach angle	Designation	Dimension (mm)						Fig.	Insert
		DCONMS	H	LF	LDRED	WF	DMIN		
93°	S05G SWUBR/L 06-D06	5	4.75	90	-	3	6	1	WB...T 0601... A335
	S06H SWUBR/L 06-D07	6	5.5	100	-	3.5	7	1	
	S07J SWUBR/L 06-D08	7	6.5	110	-	4	8	1	
	S10H SWUBR/L 06-D06	10	9	100	18	3	6	2	
93°	✓ C05H SWUBR/L 06-D06	5	4.75	100	-	3	6		
	✓ C06J SWUBR/L 06-D07	6	5.5	110	-	3.5	7		
	✓ C07K SWUBR/L 06-D08	7	6.5	125	-	4	8		

• ✓ Marked: Designates carbide shank • L-hand insert for R-hand toolholder, R-hand insert for L-hand toolholder

Spare parts

Designation	Screw	Wrench					
	...06...	TS 20038I/HG-P	T 6P				

A-SXQNR/L A-SXUNR/L



Screw type boring bars

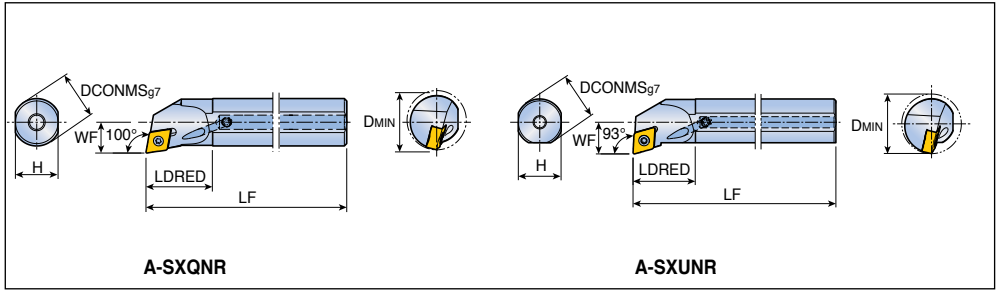

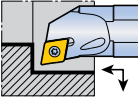
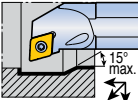
Approach angle	Designation	Dimension (mm)						Insert
		DCONMS	H	LF	LDRED	WF	DMIN	
100° 	A16Q SXQNR/L 0904	16	15	180	24.5	11	20	XNMG 0904...
	A20Q SXQNR/L 0904	20	18	180	28	13	25	RHINOXTURN
	A20Q SXQNR/L 1105	20	18	180	28	13	25	XNMG 1105...
								RHINOXTURN A305
93° 	A25R SXUNR/L 1105	25	23	200	33.4	17	32	XN... 1105...
								RHINOXTURN
								POSTURN
								A305, A306

Spare parts

Designation	Screw	Wrench				
...0904	TS 30080I/HG	T 9				
...1105	TS 40G110I	T 15				

S-TDUNR/L A-TDUNR/L



T-holder type boring bars

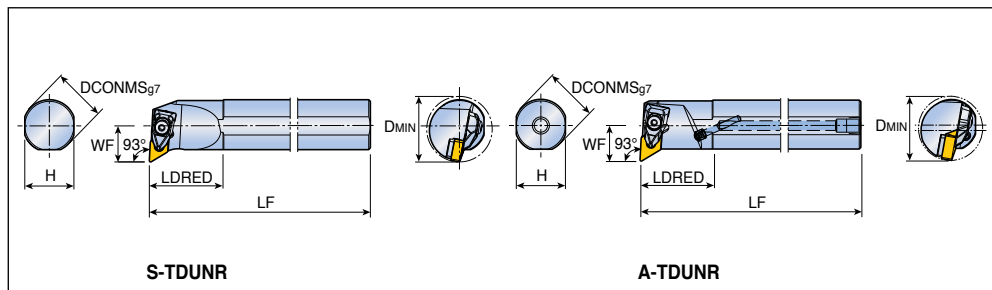

Approach angle	Designation	Dimension (mm)						Insert	
		DCONMS	H	LF	LDRED	WF	DMIN		
93°	S32S TDUNR/L 1305	32	30	250	45	22	40	DN... 1305... A276-A281	
	S40T TDUNR/L 1305	40	37	300	55	27	50		
93°	A32S TDUNR/L 1305	32	30	250	45	22	40	DN... 1305... 	
	A40T TDUNR/L 1305	40	37	300	55	27	50		
	A32T TDUNR/L 15	32	30	300	45	22	40		DN... 1506... A276-A281, A343, A354
	A40T TDUNR/L 15	40	37	300	45	27	50		
	A50U TDUNR/L 15	50	47	350	45	35	63		

Spare parts

Designation	Clamp	Clamp screw	Spring	Shim	Shim screw	Nozzle	Wrench	
S ...1305	DLM 3.5-NX	DLS 4	DSP 4	LSD 3.52B	TS 50A105I	-	L-W 3	T 20
A32S ...1305	DLM 3.5-NX	DLS 4	DSP 4	LSD 3.52B	TS 50A105I	NZ 62	L-W 3	T 20
A40T ...1305	DLM 3.5-NX	DLS 4	DSP 4	LSD 3.52B	TS 50A105I	NZ 104	L-W 3	T 20
A32T ...15	DLM 4	DLS 4	DSP 4	LSD 42	TS 50A105I	NZ 62	L-W 3	T 20
...15	DLM 4	DLS 4	DSP 4	TSD 43	SO 40050I	NZ 104	L-W 3	T 15

S-TDZNR/L A-TDZNR/L



T-holder type boring bars

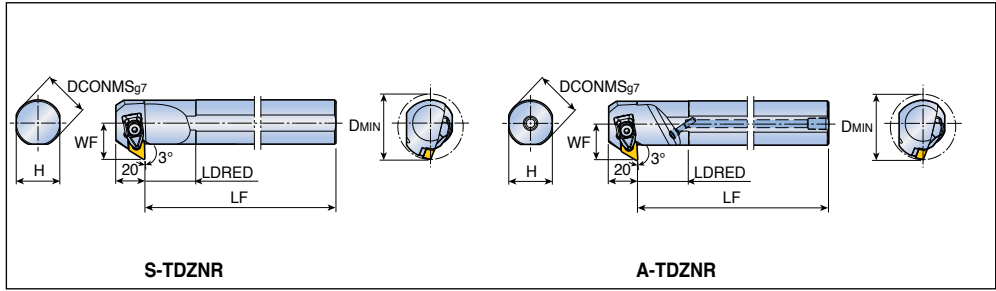

Approach angle	Designation	Dimension (mm)						Insert
		DCONMS	H	LF	LDRED	WF	DMIN	
93°	S32S TDZNR/L 1305	32	30	250	35	25	45	DN... 1305... RHINO TURN A276-A281
	S40T TDZNR/L 1305	40	37	300	40	29	50	
93°	A32S TDZNR/L 1305	32	30	250	35	25	45	
	A40T TDZNR/L 1305	40	37	300	40	29	50	

Spare parts

Designation	Clamp	Clamp screw	Spring	Shim	Shim screw	Nozzle	Wrench	
S ...1305	DLM 3.5-NX	DLS 4	DSP 4	LSD 3.52B	TS 50A105I	-	L-W 3	T 20
A32S...1305	DLM 3.5-NX	DLS 4	DSP 4	LSD 3.52B	TS 50A105I	NZ 62	L-W 3	T 20
A40T...1305	DLM 3.5-NX	DLS 4	DSP 4	LSD 3.52B	TS 50A105I	NZ 104	L-W 3	T 20

T-holder type boring bars

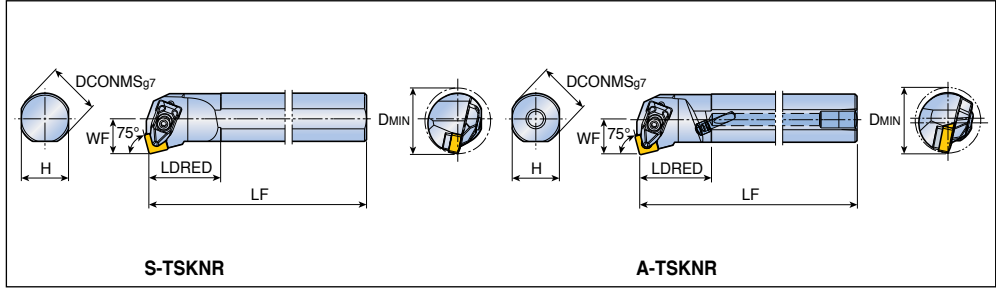

Approach angle	Designation	Dimension (mm)						Insert
		DCONMS	H	LF	LDRED	WF	DMIN	
75°	S25R TSKNR/L 0904	25	23	200	35	17	32	SN... 0904...
	S32S TSKNR/L 0904	32	30	250	35	22	40	A284-A290
75°	A25R TSKNR/L 0904	25	23	200	35	17	32	SN... 0904...
	A32S TSKNR/L 0904	32	30	250	35	22	40	
	A25T TSKNR/L 12	25	23	300	45	17	32	SN... 1204...
								A284-A290, A346, A347, A356

• L-hand insert for R-hand toolholder, R-hand insert for L-hand toolholder

Spare parts

Designation	Clamp	Clamp screw	Spring	Shim	Shim screw	Nozzle	Wrench	
S25R...0904	DLM 3-NX	DLS 3	DSP 3	LSS 32	SO 400731	-	L-W 2.5	T 15
S32S...0904	DLM 3-NX	DLS 3	DSP 3	LSS 32	SO 400851	-	L-W 2.5	T 15
A25R...0904	DLM 3-NX	DLS 3	DSP 3	LSS 32	SO 400731	NZ 62	L-W 2.5	T 15
A32S...0904	DLM 3-NX	DLS 3	DSP 3	LSS 32	SO 400851	NZ 62	L-W 2.5	T 15
A25T...12	DLM 4	DLS 4	DSP 4	LSS 42	TS 50A1051	NZ 62	L-W 3	T 20

T-holder type boring bars

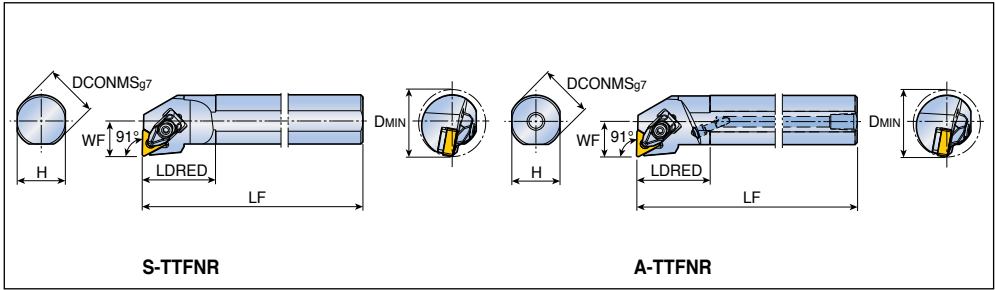

Approach angle	Designation	Dimension (mm)						Insert
		DCONMS	H	LF	LDRED	WF	DMIN	
91°	S25R TTFNR/L 1304	25	23	200	35	17	32	TN... 1304... A291-A296
	S32S TTFNR/L 1304	32	30	250	35	22	40	
91°	A25R TTFNR/L 1304	25	23	200	35	17	32	
	A32S TTFNR/L 1304	32	30	250	35	22	40	

Spare parts

Designation	Clamp	Clamp screw	Spring	Shim	Shim screw	Nozzle	Wrench	
S25R...1304							L-W 2.5	T 15
S32S...1304							L-W 2.5	T 15
A25R...1304							L-W 2.5	T 15
A32S...1304							L-W 2.5	T 15

T-holder type boring bars

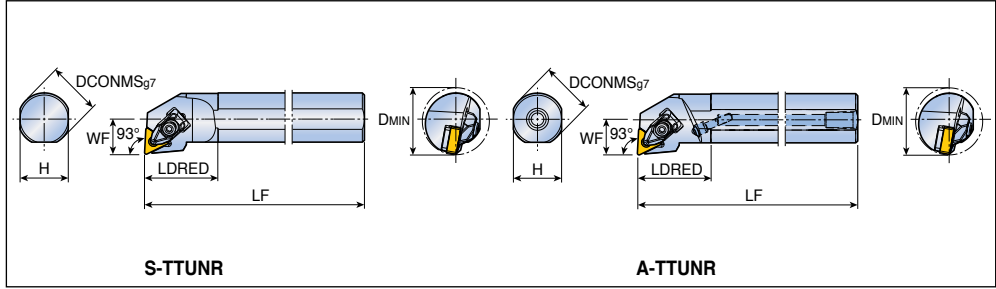





Approach angle	Designation	Dimension (mm)						Insert
		DCONMS	H	LF	LDRED	WF	DMIN	
93°	S25R TTUNR/L 1304	25	23	200	35	17	32	TN... 1304... RHINO TURN A291-A296
	S32S TTUNR/L 1304	32	30	250	35	22	40	
93°	A25R TTUNR/L 1304	25	23	200	35	17	32	
	A32S TTUNR/L 1304	32	30	250	35	22	40	

Spare parts

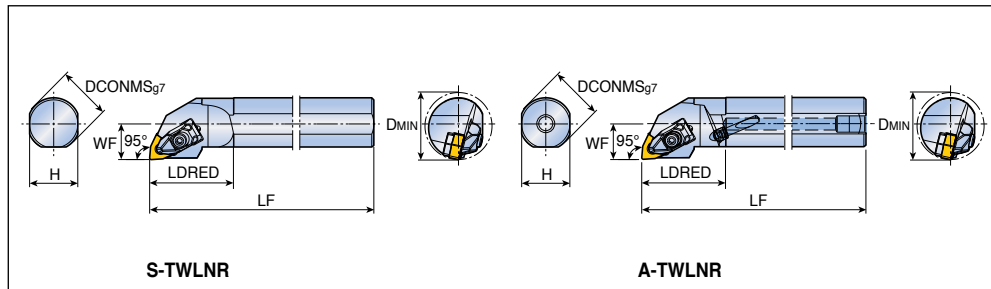
Designation	Clamp	Clamp screw	Spring	Shim	Shim screw	Nozzle	Wrench	
S25R...1304	DLM 2.5-NX	DLS 3	DSP 3	LST 2.52B	SO 40073I	-	L-W 2.5	T 15
S32S...1304	DLM 2.5-NX	DLS 3	DSP 3	LST 2.52B	SO 40085I	-	L-W 2.5	T 15
A25R...1304	DLM 2.5-NX	DLS 3	DSP 3	LST 2.52B	SO 40073I	NZ 62	L-W 2.5	T 15
A32S...1304	DLM 2.5-NX	DLS 3	DSP 3	LST 2.52B	SO 40085I	NZ 62	L-W 2.5	T 15

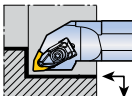
T-holder type boring bars

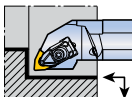

Approach angle	Designation	Dimension (mm)						Insert
		DCONMS	H	LF	LDRED	WF	DMIN	
 95°	S25R TWLNLR/L 0604	25	23	200	40	17	32	WN...X 0604...  A300-A304,
	S32S TWLNLR/L 0604	32	30	250	45	22	40	WN... 0804... A350, A359
	S25T TWLNLR/L 08	25	23	300	35	17	32	
	S32T TWLNLR/L 08	32	30	300	45	22	40	
 95°	A25R TWLNLR/L 0604	25	23	200	40	17	32	WN...X 0604... 
	A32S TWLNLR/L 0604	32	30	250	45	22	40	WN... 0604... 
	A20S TWLNLR/L 06	20	18	250	35	13	25	
	A25T TWLNLR/L 06	25	23	300	40	17	32	
	A32T TWLNLR/L 06	32	30	300	45	22	40	
	A25T TWLNLR/L 08	25	23	300	40	17	32	WN... 0804...
	A32T TWLNLR/L 08	32	30	300	45	22	40	
	A40T TWLNLR/L 08	40	37	300	45	27	50	

Spare parts





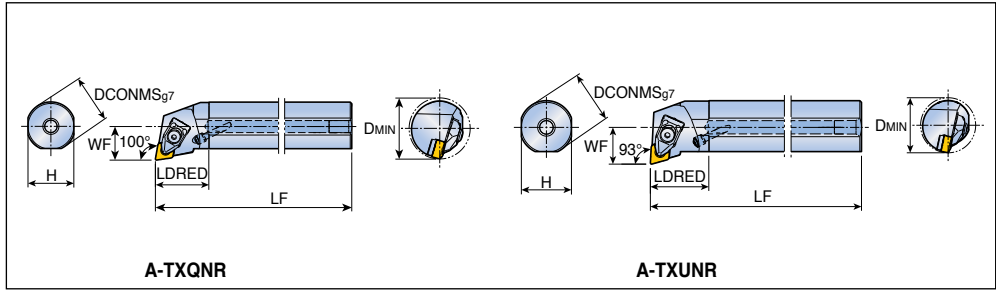

Designation	Clamp	Clamp screw	Spring	Shim	Shim screw	Nozzle	Wrench	
								
S25R...0604	DLM 3-NX	DLS 3	DSP 3	LSW 32	SO 40073I	-	L-W 2.5	T 15
S32S...0604	DLM 3-NX	DLS 3	DSP 3	LSW 32	SO 40085I	-	L-W 2.5	T 15
A25R...0604	DLM 3-NX	DLS 3	DSP 3	LSW 32	SO 40073I	NZ 62	L-W 2.5	T 15
A32S...0604	DLM 3-NX	DLS 3	DSP 3	LSW 32	SO 40085I	NZ 62	L-W 2.5	T 15
A20S...06	DLM 3	DLS 3	DSP 3	-	-	NZ 62	L-W 2.5	-
...06	DLM 3	DLS 3	DSP 3	PSW 32	SO 40090I	NZ 62	L-W 2.5	T 15
...08	DLM 4	DLS 4	DSP 4	PSW 42	TS 50A105I	NZ 62	L-W 3	T 20
A40T...08	DLM 4	DLS 4	DSP 4	TSW 44	SO 40050I	NZ 104	L-W 3	T 15

A-TXQNR/L A-TXUNR/L

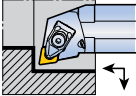

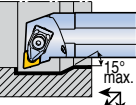







T-holder type boring bars



Approach angle	Designation	Dimension (mm)						Insert	
		DCONMS	H	LF	LDRED	WF	DMIN		
100° 	A25R TXQNR/L 1105	25	23	200	33.4	17	32	XNMG 1105...   A305	
	A32S TXQNR/L 1105	32	30	250	35	22	40		
93° 	A32S TXUNR/L 1105	32	30	250	35	22	40	XN... 1105...    A305, A306	

Spare parts

Designation	Clamp	Clamp screw	Spring	Shim	Shim screw	Nozzle	Wrench	
A25R...1105								
A25R...1105	DLM 3.5-NX	DLS 4	DSP 4	-	-	NZ 62	L-W 3	-
A32S...1105								
A32S...1105	DLM 3.5-NX	DLS 4	DSP 4	LSX 3.52B	TS 50A105I	NZ 62	L-W 3	T 20

Anti-vibration shanks for boring

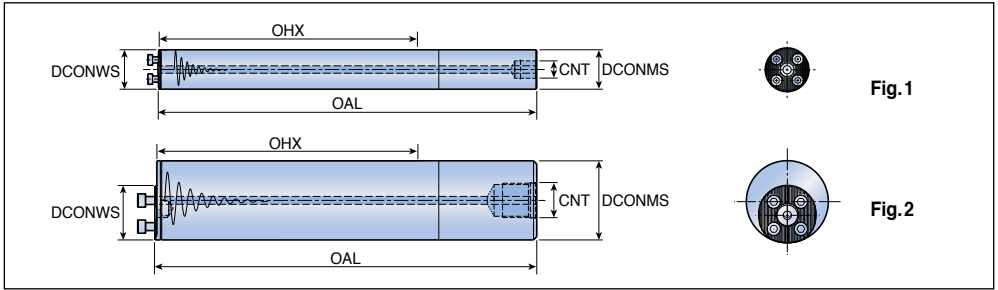

Designation	Dimension (mm)					Coolant hole	Fig.
	DCONMS	DCONWS	OAL	OHX	CNT		
QS16A-7D	16	16	156.3	92	G 1/8	●	1
QS16E-10D⁽¹⁾	16	16	204.3	140	-	●	1
QS20A-7D	20	20	200.3	120	G 1/4	●	1
QS20E-10D⁽¹⁾	20	20	260.3	180	-	●	1
QS25A-7D	25	25	257.5	155	G 1/4	●	1
QS25A-10D	25	25	332.5	230	G 1/4	●	1
QS32A-7D	32	32	323.0	192	G 3/8	●	1
QS32A-10D	32	32	419.0	288	G 3/8	●	1
QS40A-7D	40	40	411.0	251	G 1/2	●	1
QS40A-10D	40	40	531.0	368	G 1/2	●	1
QS50A-7D	50	40	523.0	318	G 1/2	●	2
QS50A-10D	50	40	673.0	468	G 1/2	●	2
QS60A-7D	60	40	633.0	388	G 3/4	●	2
QS60A-10D	60	40	813.0	568	G 3/4	●	2

• OHX: Maximum overhang

• ⁽¹⁾ Carbide shank

Spare parts

Designation	Screw	Wrench				
QS16	SH M3x0.5X10	L-W 2.5				
QS20	SH M3.5x0.6X10	L-W 2.5				
QS25	SH M4x0.7X12	L-W 3				
QS32	SH M5x0.8X12	L-W 4				
QS40/50/60	SH M6x1X16	L-W 5				

Hook lever type boring heads

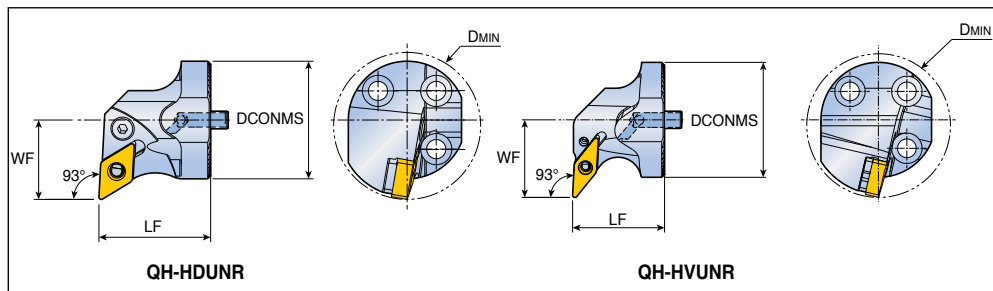

Approach angle	Designation	Dimension (mm)				Coolant hole	Insert
		DCONMS	LF	WF	DMIN		
93° 	QH40-HDUNR/L-1305 *	40	38	27	50	●	DN...G 1305... A276-A281
93° 	QH40-HVUNR/L-1304 *	40	32	27	50	●	VN...X 1304... YNMG 1304... A297-A299, A305

* When applying $\varnothing 50\text{mm}$ shank, DMIN for the assembly is $\varnothing 60\text{mm}$. When applying $\varnothing 60\text{mm}$ shank, DMIN for the assembly is $\varnothing 70\text{mm}$.

Spare parts

Designation	Lever	Lever screw	Shim		Shim pin	Wrench	
HDUNR/L-1305	LCL 11-NX	LCS 4S	LSD 3.52B	-	LSP 4	L-W 3	
HVUNR/L-1304	LCL 08-NX	LCS 4-DH	-	LSV 2.51.8H	LSP 3B	L-W 2.5	

Turning Inserts



C **N** **M** **G**

1 **2** **3** **4**

1 Shape

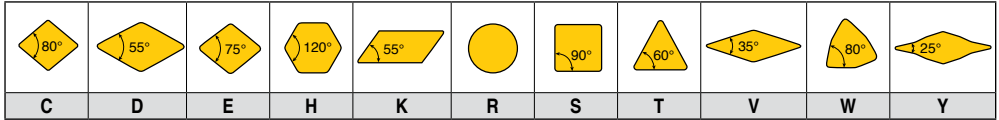

2 Clearance angle

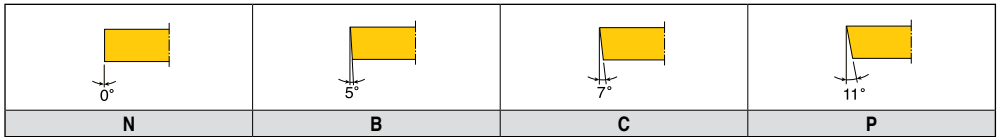

3 Tolerance

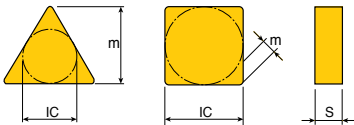

Class	m	S	IC
A	±0.005	±0.025	±0.025
F	±0.005	±0.025	±0.013
C	±0.013	±0.025	±0.025
H	±0.013	±0.025	±0.013
E	±0.025	±0.025	±0.025
G	±0.025	±0.13	±0.025
M	±0.08~±0.18	±0.13	±0.05~±0.13
U	±0.13~±0.38	±0.13	±0.08~±0.25

Diameter of IC	Tolerance			
	On m		On IC	
	Class M	Class U	Class M	Class U
6.35	±0.08	±0.13	±0.05	±0.08
9.52	±0.08	±0.13	±0.05	±0.08
12.70	±0.13	±0.20	±0.08	±0.13
15.88	±0.15	±0.27	±0.10	±0.18
19.05	±0.15	±0.27	±0.10	±0.18
25.40	±0.18	±0.38	±0.13	±0.25
31.75	±0.18	±0.38	±0.13	±0.25

4 Type

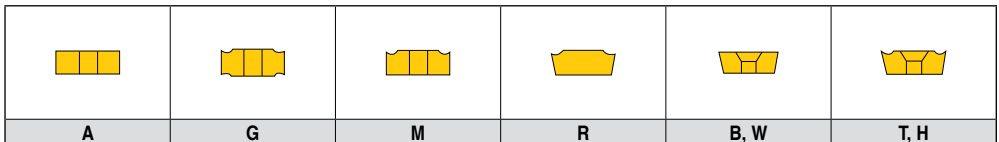

12 **04** **08** (**R**) **MP**

5 6 7 8 9

5 Cutting edge length

I.C(mm)	C	D	E	R	S	T	V, Y	W	K	H
3.97	03	04			03	06		02		
4.76	04	05			04	08	08			
5.56	05	06			05	09	09	03		
6.35	06	07			06	11	11			
7.94	08	09			07	13	13	05		
8.0				08						
9.52	09	11		09	09	16	16	06	16	
10.0				10						
11.11		13								
12.0				12						
12.7	12	15	13		12	22	22	08		05
15.88	16	19		15	15	27	27	10		
16.0				16						
19.05	19	23		19	19	33	33	13		10
20.0				20						
25.0				25						
25.4	25	31		25	25	44	44	17		
31.75	32	38			31	54	54	21		
32.0				32						

6 Thickness

01	1.59mm
T1	1.98mm
02	2.38mm
T2	2.78mm
03	3.18mm
T3	3.97mm
04	4.76mm
05	5.56mm
06	6.35mm
07	7.94mm
09	9.52mm

7 Corner radius

01	0.1mm
02	0.2mm
04	0.4mm
05	0.5mm
08	0.8mm
12	1.2mm
16	1.6mm
20	2.0mm
24	2.4mm
32	3.2mm

8 Hand of insert

R: Right hand

L: Left hand



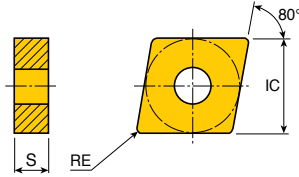

9 Chip breaker

For chip breakers, see page A33-A46

Negative 80° rhombic inserts



Size	Dimension (mm)		
	IC	S	RE
09	9.52	4.76	0.1-1.2
12	12.7	4.76	0.1-1.6
16	15.88	6.35	1.2-1.6
19	19.05	6.35	0.8-1.6

Insert	Designation	ap (mm)	Feed (mm/rev)	Coating																			
				Cermat		CVD coated								PVD coated									
				PV3010	CT3000	TT3005	TT7015	TT7025	TT8105B	TT8125B	TT8135B	TT9215	TT9225	TT9235	TT15100	TT7100	TT5080	TT8020	TT9080	TT3010	TT3020	TT9020	K10
 Medium	CNGG 090401 ML	0.1-1.0	0.03-0.10														●						●
	090402 ML	0.2-1.2	0.05-0.15														●						●
	090404 ML	0.5-1.5	0.05-0.20														●						●
	090408 ML	0.5-1.5	0.08-0.25														●						●
 Medium	CNGG 120401 ML	0.1-3.5	0.03-0.10														●	●					
	120402 ML	0.2-3.5	0.05-0.15														●	●					●
	120404 ML	0.8-3.5	0.10-0.30														●	●					●
	120408 ML	1.0-3.5	0.12-0.35														●	●					●
 Roughing	CNMA 090408	1.0-3.0	0.15-0.60				●	●															
	090412	1.0-3.0	0.15-0.70				●	●															
 Roughing	CNMA 120404	1.0-5.0	0.15-0.50				●	●	●														●
	120408	1.0-6.0	0.15-0.60				●	●	●														●
	120412	1.5-6.0	0.15-0.70				●	●	●	●													
	120416	2.0-6.0	0.20-0.80				●	●	●														
	160612	2.0-8.0	0.15-0.70				●	●	●														
	160616	2.0-8.0	0.20-0.80					●															
	190608	2.0-10.0	0.15-0.70						●														
	190612	2.0-10.0	0.15-0.70						●	●													
	190616	3.0-10.0	0.15-1.00						●	●	●												
 Roughing	CNMA 120408 WT	0.7-5.0	0.15-0.80				●																

● : Standard items

 A55, A69-A71, A86, A120-A122, A176, A178, A199, A208, A214, A237-A239, A253

Negative 80° rhombic inserts

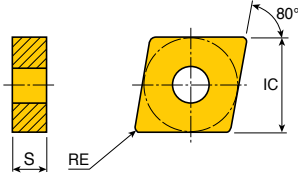

Size	Dimension (mm)		
	IC	S	RE
19	19.05	6.35	2.4
25	25.4	9.52	2.4

Insert	Designation	ap (mm)	Feed (mm/rev)	Coating																						
				Cermet			CVD coated							PVD coated												
				PV3010	CT3000	TT3005	TT7005	TT7015	TT7025	TT8105B	TT8115B	TT8125B	TT8135B	TT9215	TT9225	TT9235	TT15100	TT17100	TT15080	TT18020	TT19080	TT13010	TT13020	TT19020	K10	
	CNMD 250924 HD												●	●	●											
	Roughing	4.0-15.0	0.55-1.50																							
	Finishing	2.0-5.0	0.40-0.80																							
	CNMD 190624 HT												●	●												
	Roughing	4.0-9.0	0.35-0.90																							
	Finishing	2.0-5.0	0.40-0.80																							
	250924 HT												●	●												
	Roughing	5.0-12.0	0.55-1.30																							
	Finishing	2.0-5.0	0.40-0.80																							
	CNMD 190624 HY												●	●												
	Roughing	4.0-12.0	0.50-1.10																							
	Finishing	2.0-5.0	0.40-0.80																							
	250924 HY												●	●	●											
	Roughing	4.0-15.0	0.55-1.50																							
	Finishing	2.0-5.0	0.40-0.80																							
	CNMD 250924 HZ												●	●	●											
	Roughing	4.0-15.0	0.55-1.50																							
	Finishing	2.0-5.0	0.40-0.80																							

A69, A71

●: Standard items



Negative 80° rhombic inserts

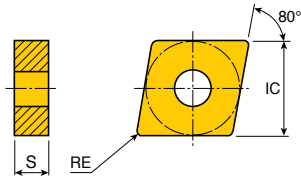

Size	Dimension (mm)		
	IC	S	RE
09	9.52	4.76	0.4-1.2
12	12.7	4.76	0.4-1.2
16	15.88	6.35	1.2

Insert	Designation	ap (mm)	Feed (mm/rev)	Cermat		CVD coated										PVD coated							
				PV3010	CT3000	TT3005	TT7005	TT7015	TT7025	TT8105B	TT8115B	TT8125B	TT8135B	TT9215	TT9235	TT15100	TT7100	TT5080	TT8020	TT9080	TT3010	TT3020	TT9020
	CNMG 120404 MC	0.5-3.5	0.10-0.30					●	●	●					●	●		●					
	120408 MC	0.7-3.5	0.12-0.35							●	●				●								
	120412 MC	0.7-3.5	0.15-0.40							●													
Medium																							
	CNMG 120408 MGP	0.5-5.0	0.15-0.55							●	●												
	120412 MGP	0.6-5.0	0.17-0.55							●	●												
Medium																							
	CNMG 120408 MGS	1.0-4.0	0.15-0.40			●													●	●	●		
	120412 MGS	1.5-4.0	0.17-0.50			●													●	●	●		
Medium																							
	CNMG 090404 MK	0.7-3.0	0.17-0.40											●	●		●	●					
	090408 MK	1.0-3.0	0.20-0.50											●	●		●	●	●	●			
	090412 MK	1.2-3.0	0.23-0.50											●	●		●	●					
Medium																							
	CNMG 120404 ML	0.8-3.5	0.10-0.30								●	●	●	●	●		●	●					●
	120408 ML	1.0-3.5	0.12-0.35								●	●	●	●	●		●	●	●				●
	120412 ML	1.3-3.5	0.15-0.35												●		●						●
Medium																							
	CNMG 120408 MLP	0.5-3.5	0.10-0.40							●	●	●											
	120412 MLP	0.6-3.5	0.15-0.50							●	●	●											
Medium																							
	CNMG 090404 MM	0.4-3.0	0.15-0.45								●	●	●	●	●	●		●					
	090408 MM	0.5-3.0	0.20-0.50								●	●	●	●	●	●		●					
	090412 MM	0.7-3.0	0.23-0.50								●	●	●	●	●	●		●					
Medium																							
	CNMG 120404 MP	0.8-4.0	0.10-0.30								●	●	●	●	●		●	●					
	120408 MP	1.0-4.0	0.12-0.40								●	●	●	●	●	●		●	●				
	120412 MP	1.5-4.0	0.15-0.50								●	●	●	●	●		●	●					
	160612 MP ✓	2.5-6.0	0.15-0.50									●											
Type B Medium																							

A55, A69-A71, A86,
A120-A122, A176, A178, A199,
A208, A214, A237-A239, A253

● ✓ Marked: Type B chip breaker

●: Standard items

Negative 80° rhombic inserts

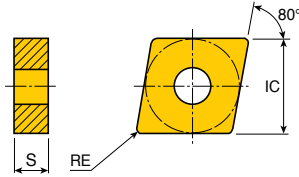

Size	Dimension (mm)		
	IC	S	RE
09	9.52	4.76	0.4-1.2
12	12.7	4.76	0.4-1.6
16	15.88	6.35	0.8-1.6
19	19.05	6.35	0.8-1.6

Insert	Designation	ap (mm)	Feed (mm/rev)	Coating																				
				Cermet		CVD coated								PVD coated										
				PV3010	CT3000	TT3005	TT7005	TT7015	TT7025	TT18105B	TT18115B	TT18125B	TT18135B	TT9215	TT9225	TT15100	TT7100	TT15080	TT18020	TT19080	TT13010	TT13020	TT19020	K10
Medium	CNMG 090404 MT	0.8-3.0	0.10-0.35							●	●	●	●			●								
	090408 MT	1.0-3.0	0.15-0.45							●	●	●	●			●		●		●				
	090412 MT	1.2-3.0	0.20-0.55							●	●	●	●			●								
Medium	CNMG 120404 MT	1.0-5.0	0.15-0.40	●		●	●	●		●	●					●		●	●					
	120408 MT	1.2-5.0	0.17-0.55	●	●		●	●	●	●	●	●	●	●	●	●	●	●	●	●	●	●	●	●
	120412 MT	1.5-5.0	0.20-0.55				●	●		●	●	●	●	●	●	●	●	●	●	●	●	●	●	●
	160608 MT ✓	2.0-6.5	0.20-0.55				●				●													
	160612 MT ✓	2.0-6.5	0.25-0.55				●				●	●				●		●	●					
	160616 MT	2.0-6.5	0.30-0.55								●													
	190608 MT	3.0-8.0	0.23-0.55				●				●	●	●	●	●	●	●	●	●	●	●	●	●	●
	190612 MT	3.0-8.0	0.25-0.55								●	●	●	●	●	●	●	●	●	●	●	●	●	●
	190616 MT	3.0-8.0	0.30-0.55								●													
Medium	CNMG 090404 PC	0.4-3.0	0.10-0.30							●	●	●	●			●					●			
	090408 PC	0.5-3.0	0.15-0.40							●	●	●	●			●					●			
	090412 PC	0.6-3.0	0.18-0.50							●	●	●	●			●					●			
Medium	CNMG 120404 PC	0.4-5.0	0.10-0.40							●	●	●	●	●	●	●								
	120408 PC	0.5-5.0	0.15-0.50							●	●	●	●	●	●	●					●			
	120412 PC	0.6-5.0	0.17-0.55							●	●	●	●	●	●	●					●			
	120416 PC	0.8-5.0	0.20-0.60							●	●	●	●	●	●	●	●				●			
	160608 PC	2.0-6.5	0.20-0.55							●	●													
	160612 PC	2.0-6.5	0.25-0.55							●	●													
	160616 PC	2.0-6.5	0.30-0.55							●	●													
	190608 PC	3.0-8.0	0.23-0.55							●	●	●	●	●	●	●	●	●	●	●	●	●	●	●
	190612 PC	3.0-8.0	0.25-0.55							●	●	●	●	●	●	●	●	●	●	●	●	●	●	●
	190616 PC	3.0-8.0	0.30-0.55							●														
Roughing	CNMG 120408 RGP	2.5-6.0	0.25-0.70							●	●													
	120412 RGP	2.5-6.0	0.25-0.70							●	●													
	120416 RGP	2.5-6.0	0.30-0.70							●	●													
	190616 RGP	3.0-9.0	0.30-0.85							●	●													

A55, A69-A71, A86, ✓ Marked: Type B chip breaker ● : Standard items
 A120-A122, A176, A178, A199,
 A208, A214, A237-A239, A253

Negative 80° rhombic inserts

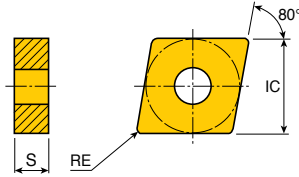

Size	Dimension (mm)		
	IC	S	RE
09	9.52	4.76	0.4-1.2
12	12.7	4.76	0.4-1.6
16	15.88	6.35	1.2-1.6
19	19.05	6.35	0.8-1.6
25	25.4	9.52	2.4

Insert	Designation	ap (mm)	Feed (mm/rev)	Cermet		CVD coated										PVD coated										
				PV3010	CT3000	TT3005	TT7005	TT7015	TT7025	TT8105B	TT8115B	TT8125B	TT8135B	TT9215	TT9225	TT9235	TT15100	TT17100	TT15080	TT8020	TT9080	TT3010	TT3020	TT9020	K10	
 Type B Roughing	CNMG 120408 RT	2.5-6.0	0.25-0.70			•	•	•	•	•	•	•	•	•	•	•	•	•								
	120412 RT ✓	2.5-6.0	0.25-0.70			•	•	•	•	•	•	•	•	•	•	•	•	•								
	120416 RT	2.5-6.0	0.30-0.70					•	•	•																
	160612 RT	3.0-7.0	0.25-0.70					•	•	•	•					•	•	•								
	160616 RT	3.0-7.0	0.30-0.85					•	•	•	•															
	190608 RT	3.0-9.0	0.25-0.70							•	•															
	190612 RT	3.0-9.0	0.25-0.70						•	•	•	•	•		•	•	•	•								
	190616 RT	3.0-9.0	0.30-0.85						•	•	•	•	•			•	•	•			•					
	250924 RT	5.0-12.0	0.45-1.00								•	•					•									
 Finishing	CNMG 120404 SF	0.5-1.5	0.08-0.25																							
	120408 SF	0.7-1.5	0.10-0.30																							
 Wiper Finishing	CNMG 090404 WA	0.25-2.5	0.08-0.25					•	•	•	•															
	090408 WA	0.25-3.0	0.10-0.40					•	•	•	•															
	090412 WA	0.4-3.0	0.20-0.50					•	•	•	•															
 Wiper Finishing	CNMG 120404 WS	0.5-2.0	0.05-0.35																							
 Wiper Medium	CNMG 120408 WT	1.0-5.0	0.15-0.60					•	•	•	•															
	120412 WT	1.0-5.0	0.20-0.80																							

- A55, A69-A71, A86,
- A120-A122, A176, A178, A199,
- A208, A214, A237-A239, A253

• ✓ Marked: Type B chip breaker

•: Standard items



Negative 80° rhombic inserts

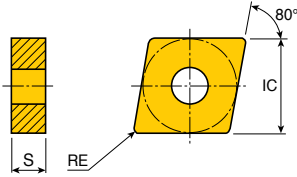

Size	Dimension (mm)		
	IC	S	RE
19	19.05	6.35	1.2-2.4
25	25.4	7.94-9.52	2.4-3.2

Insert	Designation	ap (mm)	Feed (mm/rev)	Coating																						
				Cermet		CVD coated										PVD coated										
				PV3010	CT3000	TT3005	TT7005	TT7015	TT7025	TT8105B	TT8115B	TT8125B	TT8135B	TT9215	TT9225	TT9235	TT15100	TT17100	TT15080	TT18020	TT19080	TT13010	TT13020	TT19020	K10	
Roughing	CNMM 250924 EH	2.5-15.0	0.45-1.20												●	●	●									
Roughing	CNMM 190612 HT	4.0-9.0	0.35-0.90								●						●									
	190616 HT	4.0-9.0	0.45-1.00								●	●														
	190624 HT	4.0-9.0	0.55-1.20								●	●						●								
	250724 HT	5.0-12.0	0.55-1.30															●	●							
	250924 HT	5.0-12.0	0.55-1.30																●							
	250932 HT	5.0-13.0	0.65-1.30																●							
Roughing	CNMM 190624 HY	4.0-12.0	0.50-1.10								●	●														
	250924 HY	4.0-15.0	0.55-1.50								●	●	●													
Roughing	CNMM 250924 HZ	4.0-15.0	0.55-1.50								●	●														

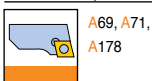

● : Standard items

Negative 80° rhombic inserts

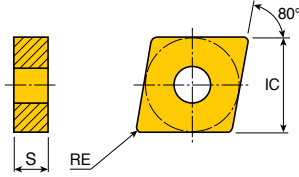

Size	Dimension (mm)		
	IC	S	RE
07	7.0	3.18	0.4-0.8
12	12.7	4.76-5.56	0.8-1.2
16	15.88	6.35-7.94	0.8-2.4
19	19.05	6.35	0.8-2.4
25	25.4	7.94-9.52	2.4

Insert	Designation	ap (mm)	Feed (mm/rev)	Coating																						
				Cermet		CVD coated						PVD coated				K10										
				PV3010	CT3000	TT3005	TT7005	TT7015	TT7025	TT8105B	TT8115B	TT8125B	TT8135B	TT9215	TT9225		TT9235	TT15100	TT17100	TT15080	TT18020	TT19080	TT13010	TT13020	TT19020	
 Roughing	CNMM 120408 RH	2.5-6.0	0.30-0.70								●	●					●									
	120412 RH	2.5-6.0	0.30-0.80								●	●					●									
	160608 RH	3.0-8.0	0.30-0.70									●										●				
	160612 RH	3.0-8.0	0.30-0.80								●	●					●									
	160616 RH	4.0-8.0	0.45-1.00								●	●					●									
	190608 RH *	3.0-9.0	0.30-0.70																							
	190612 RH	4.0-9.0	0.35-0.80									●	●					●	●							
	190616 RH	4.0-9.0	0.45-1.00									●	●		●			●								
	190624 RH	4.0-9.0	0.55-1.20									●	●					●								
	250924 RH *	5.0-12.0	0.55-1.20										●													
 Roughing	CNMM 120408 RX	0.7-7.0	0.20-0.55								●	●														
	120412 RX	1.0-7.0	0.25-0.70								●	●														
	160612 RX	1.0-9.0	0.25-0.70								●							●								
	160616 RX	1.5-9.0	0.30-0.90								●	●	●		●	●										
	160624 RX	2.0-9.0	0.35-1.20								●	●														
	190608 RX	0.7-10.0	0.20-0.55									●														
	190612 RX	1.0-10.0	0.25-0.70									●	●													
	190616 RX	1.5-10.0	0.30-0.90									●	●													
	190624 RX	2.0-10.0	0.35-1.10									●	●													
	250724 RX	2.0-12.0	0.35-1.20									●														
250924 RX	2.0-12.0	0.35-1.20									●															
 Finishing	CNMX 070304 FGP	0.3-2.0	0.05-0.25	●							●	●						●				●				
	070308 FGP	0.4-2.0	0.08-0.25	●							●	●						●				●				

A69-A71, A85,
 A120, A121, A178,
 A208, A214, A237-A239, A256

● * Marked: Chip breaker shape is not the same as shown in the catalogue

●: Standard items

Negative 55° rhombic inserts

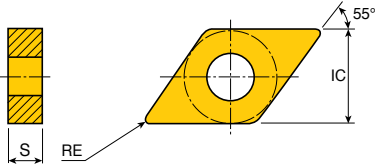

Size	Dimension (mm)		
	IC	S	RE
08	7.0	3.18	0.1-0.4
13	11.11	5.56	0.1-1.2
15	12.7	4.76-6.35	0.1-1.6

Insert	Designation	ap (mm)	Feed (mm/rev)	Coating																					
				Cermet		CVD coated							PVD coated					K10							
				PV3010	CT3000	TT3005	TT7005	TT7015	TT7025	TT8105B	TT8115B	TT8125B	TT8135B	TT9215	TT9225	TT9235	TT5100		TT7100	TT5080	TT3010	TT3020	TT9020	TT4410	TT4430
Finishing For Swiss	DNGG 130501M FU-F	0.2-2.5	0.03-0.12																					●	●
	130502M FU-F	0.2-2.5	0.04-0.12																					●	●
	130504M FU-F	0.4-2.5	0.05-0.12																					●	●
Medium	DNGG 130501 ML	0.1-1.0	0.03-0.10																●						●
	130502 ML	0.2-1.2	0.05-0.15																●						●
	130504 ML	0.5-1.5	0.05-0.20																●						●
	130508 ML	0.5-1.5	0.08-0.25																●						●
Medium	DNGG 150401 ML	0.1-1.0	0.03-0.10																●						●
	150402 ML	0.2-1.2	0.05-0.15																●						●
	150404 ML	0.8-3.5	0.10-0.30																●						●
	150408 ML	1.0-3.5	0.12-0.35																●						●
Finishing For Swiss	DNGX 080301M SM-F	0.1-1.0	0.02-0.10										●									●		●	
	080302M SM-F	0.2-1.2	0.02-0.12																			●		●	
	080304M SM-F	0.2-1.5	0.02-0.15																			●		●	
Roughing	DNMA 150408	0.8-4.0	0.15-0.65				●	●																	
	150608	0.8-4.0	0.15-0.65				●	●																	
	150412	1.2-4.0	0.15-0.65				●	●																	
	150612	1.2-4.0	0.15-0.65					●																	
Medium	DNMG 130504	0.5-3.5	0.10-0.45				●	●																	
	130508	0.5-3.5	0.10-0.50				●	●												●	●				
	130512	0.5-3.5	0.10-0.55				●	●																	
Medium	DNMG 150404	1.0-4.0	0.17-0.45				●					●													
	150604	1.0-4.0	0.17-0.45				●	●				●	●				●								
	150408	1.5-4.0	0.17-0.55				●	●				●	●												
	150608	1.5-4.0	0.17-0.55				●	●	●			●	●	●				●							●
	150412	1.5-4.0	0.25-0.55				●					●													
	150612	1.5-4.0	0.25-0.55				●		●			●	●					●							
	150416	2.5-4.0	0.25-0.65																						
150616	2.5-4.0	0.25-0.65										●													

A56, A57, A63, A64, A72, A73, A89, A93,
A115, A123, A124, A167, A176, A178,
A200, A209, A216-A218, A240, A241, A254, A258

● : Standard items



Negative 55° rhombic inserts

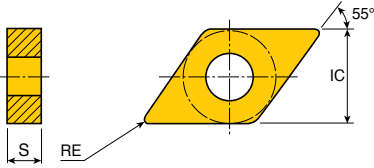

Size	Dimension (mm)		
	IC	S	RE
11	9.52	4.76	0.8-1.2
13	11.11	5.56	0.4-1.2
15	12.7	4.76-6.35	0.4-1.6

Insert	Designation	ap (mm)	Feed (mm/rev)	Coating																					
				Cermat		CVD coated							PVD coated				K10								
				PV3010	CT3000	TT3005	TT7005	TT7015	TT7025	TT8105B	TT8115B	TT8125B	TT8135B	TT9215	TT9225	TT9235		TT15100	TT17100	TT5080	TT8020	TT9080	TT3010	TT3020	TT9020
 Type B Medium	DNMG 150404 MP	0.8-4.0	0.10-0.30							•				•	•	•			•						
	150604 MP	0.8-4.0	0.10-0.30							•	•			•	•	•			•						
	150408 MP	1.0-4.0	0.12-0.40							•						•	•			•	•				
	150608 MP	1.0-4.0	0.12-0.40							•	•				•	•	•			•	•	•			
	150612 MP ✓	1.0-4.0	0.15-0.40							•					•	•	•	•		•					
 RHINO TURN Medium	DNMG 130504 MT	0.8-4.0	0.10-0.35							•	•	•					•								
	130508 MT	1.0-4.0	0.15-0.45							•	•	•					•								
	130512 MT	1.2-4.0	0.20-0.55							•	•	•					•								
 Medium	DNMG 110408 MT #	1.0-3.0	0.17-0.40	•		•	•			•	•					•			•						
	110412 MT #	1.0-3.0	0.20-0.45			•	•			•															
	150404 MT	0.8-4.0	0.15-0.40	•			•	•		•	•					•									
	150604 MT	0.8-4.0	0.15-0.40	•		•	•	•		•	•					•			•						
	150408 MT	1.0-4.0	0.17-0.50	•			•	•		•	•			•	•	•			•	•					
	150608 MT	1.0-4.0	0.17-0.50	•		•	•	•		•	•			•	•	•	•		•	•					
	150412 MT	1.3-4.0	0.20-0.50				•			•							•								
150612 MT	1.3-4.0	0.20-0.50				•	•	•		•	•					•			•	•					
 RHINO TURN Medium	DNMG 130504 PC	0.4-3.5	0.10-0.30							•	•	•	•			•									
	130508 PC	0.5-3.5	0.15-0.40							•	•	•	•			•									
	130512 PC	0.6-3.5	0.18-0.50							•	•	•	•			•									
 Medium	DNMG 110408 PC #	0.5-3.0	0.17-0.40							•	•	•													
	150404 PC	0.4-4.0	0.10-0.40							•	•														
	150604 PC	0.4-4.0	0.10-0.40							•	•			•	•	•									
	150408 PC	0.5-4.0	0.15-0.50							•	•					•									
	150608 PC	0.5-4.0	0.15-0.50							•	•			•	•	•	•								
	150412 PC	0.6-4.0	0.17-0.55							•	•					•									
	150612 PC	0.6-4.0	0.17-0.55							•	•					•									
 Roughing	DNMG 150408 RT	2.0-4.0	0.25-0.65					•	•	•	•					•									
	150608 RT	2.0-4.0	0.25-0.65					•	•	•	•					•									
	150412 RT	2.5-4.0	0.25-0.65						•		•														
	150612 RT	2.5-4.0	0.25-0.65					•	•	•	•					•									
	150616 RT	2.5-5.5	0.25-0.70								•	•				•									



A56, A57, A63, A64, A72, A73, A89, A93, A115, A123-A126, A167, A176, A178, A200-A202, A209, A216-A218, A240, A241, A254, A258

- ✓ Marked: Type B chip breaker
- # Marked: Insert with screw hole

• : Standard items

Negative 120° hexagonal inserts

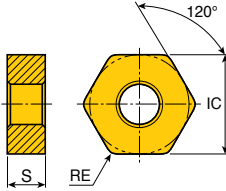

Size	Dimension (mm)		
	IC	S	RE
05	12.7	4.76	0.8
10	19.05	6.35	1.2

Insert	Designation	ap (mm)	Feed (mm/rev)	Cermet		CVD coated								PVD coated				K10							
				PV3010	CT3000	TT3005	TT7005	TT7015	TT7025	TT8105B	TT8115B	TT8125B	TT8135B	TT9215	TT9225	TT9235	TT15100		TT7100	TT5080	TT8020	TT9080	TT3010	TT3020	TT9020
 Medium	HNMG 050408 GU	0.5-3.5	0.15-0.60				●	●								●									
	100612 GU	1.0-5.0	0.25-0.70				●	●			●														
 Medium	HNMG 050408 SU	0.5-3.5	0.15-0.50												●		●		●						
	100612 SU	1.0-5.0	0.25-0.70															●							



A127, A242

● : Standard items

KNUX

Negative 55° rhombic inserts

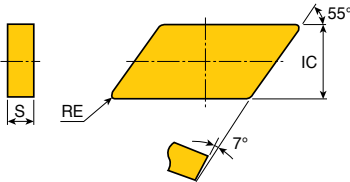

Size	Dimension (mm)		
	IC	S	RE
16	9.52	4.76	0.5-1.0

Insert	Designation	ap (mm)	Feed (mm/rev)	Cermet		CVD coated								PVD coated				K10								
				PV3010	CT3000	TT3005	TT7005	TT7015	TT7025	TT8105B	TT8115B	TT8125B	TT8135B	TT9215	TT9225	TT9235	TT15100		TT7100	TT5080	TT8020	TT9080	TT3010	TT3020	TT9020	
 Right hand Medium	KNUX 160405 L11	1.5-5.0	0.15-0.35									●	●		●	●										●
	160405 R11	1.5-5.0	0.15-0.35				●					●	●		●	●		●								
	160410 L11	2.0-5.0	0.21-0.45									●	●		●	●										
	160410 R11	2.0-5.0	0.21-0.45									●	●		●	●										
 Right hand Medium	KNUX 160405 L12	2.0-5.0	0.24-0.50												●											
	160405 R12	2.0-5.0	0.24-0.50												●											
	160410 L12	2.5-6.0	0.30-0.60									●														
	160410 R12	2.5-6.0	0.30-0.60									●														





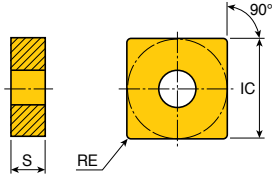

A51, A196

● : Standard items

Negative square inserts



Size	Dimension (mm)		
	IC	S	RE
12	12.7	4.76	0.8-1.6
15	15.88	6.35	1.2-1.6
19	19.05	6.35	1.2-1.6
25	25.4	7.94-9.52	2.4
31	31.75	9.52	2.4

Insert	Designation	ap (mm)	Feed (mm/rev)	Cermets		CVD coated										PVD coated									
				PV3010	CT3000	TT3005	TT7005	TT7015	TT7025	TT8105B	TT8125B	TT8155B	TT8155BB	TT9215	TT9225	TT9235	TT15100	TT17100	TT15080	TT18020	TT19080	TT13010	TT13020	TT19020	K10
 Roughing	SNMA 120408	1.0-6.0	0.15-0.70				●	●																	●
	120412	1.5-6.0	0.20-0.80				●	●																	
	120416	2.0-6.0	0.30-1.00				●	●																	
	150612	2.0-8.0	0.20-0.80				●																		
	150616	2.0-8.0	0.30-1.00				●		●																
	190612	2.0-10.0	0.20-0.80				●	●																	●
	190616	2.0-10.0	0.30-1.00				●																		
	250724	3.0-13.0	0.40-1.20				●		●																
 Roughing	SNMD 250924 HD																								
	Roughing	4.0-15.0	0.55-1.50																						
 Finishing	Finishing	2.0-5.0	0.40-0.80																						
 Roughing	SNMD 310924 HD																								
	Roughing	7.0-25.0	0.60-1.50																						
 Finishing	Finishing	2.0-5.0	0.40-0.80																						

● : Standard items

 A58, A77, A78,
 A128, A129, A179,
 A210, A243

Negative square inserts

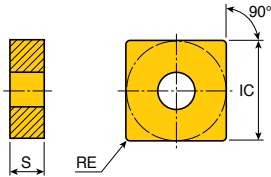

Size	Dimension (mm)		
	IC	S	RE
09	9.52	4.76	0.8-1.2
12	12.7	4.76	0.4-1.6
15	15.88	6.35	0.8-1.6
19	19.05	6.35	0.4-1.6
25	25.4	7.94-9.52	1.6-2.4

Insert	Designation	ap (mm)	Feed (mm/rev)	CVD coated														K10							
				Cermet		CVD coated										PVD coated									
				PV3010	CT3000	TT3005	TT7005	TT7015	TT7025	TT8105B	TT8115B	TT8125B	TT8135B	TT9215	TT9225	TT9235	TT15100	TT17100	TT15080	TT18020	TT19080	TT13010	TT13020	TT19020	
 Medium	SNMG 090408	0.5-3.0	0.10-0.50				●	●																	
	090412	0.5-3.0	0.10-0.55				●	●																	
 Medium	SNMG 120404	1.0-5.0	0.17-0.45							●	●						●								
	120408	1.5-5.0	0.23-0.60				●	●	●	●	●	●					●								
	120412	2.0-5.0	0.25-0.60					●			●														
	120416	2.0-5.0	0.35-0.70								●							●							
	150608	1.5-6.0	0.25-0.60								●							●							
	150612	2.0-6.0	0.25-0.60								●														
	150616	2.0-6.0	0.35-0.70								●							●							
	190604	3.0-8.0	0.17-0.45									●													
	190608	3.0-8.0	0.25-0.60					●			●	●								●					
	190612	3.0-8.0	0.30-0.60					●	●		●	●	●					●							
	190616	3.0-8.0	0.35-0.70								●	●	●					●							
	250716	4.0-12.0	0.35-0.70								●	●						●							
	250724	5.0-12.0	0.50-1.00								●	●						●							
250924	5.0-12.0	0.50-1.00									●														
 Finishing	SNMG 120404 EA	0.1-1.5	0.05-0.20														●	●		●					
	120408 EA	0.1-1.5	0.10-0.40														●	●		●					
 Medium	SNMG 090408 EM	0.5-3.0	0.13-0.40																●						
	090412 EM	0.7-3.0	0.15-0.40																		●				

● : Standard items

A77, A78, A128, A129, A177, A179, A210, A243

Negative square inserts

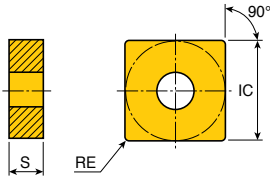

Size	Dimension (mm)		
	IC	S	RE
09	9.52	4.76	0.8-1.2
12	12.7	4.76	0.4-1.6
15	15.88	6.35	1.2-1.6
19	19.05	6.35	0.8-1.6

Insert	Designation	ap (mm)	Feed (mm/rev)	CVD coated														K10							
				Cermat				CVD coated						PVD coated											
				PV3010	CT3000	TT3005	TT7005	TT7015	TT7025	TT8105B	TT8115B	TT8125B	TT8135B	TT9215	TT9225	TT9235	TT5100	TT7100	TT5080	TT8020	TT9080	TT3010	TT3020	TT9020	
Medium	SNMG 120408 EM	0.8-5.0	0.13-0.50											•	•	•			•		•				
	120412 EM	0.8-5.0	0.15-0.55											•	•	•			•						
	150612 EM	0.8-6.5	0.15-0.55											•	•	•			•	•					
	150616 EM	0.8-6.5	0.17-0.60											•	•	•			•	•					
	190612 EM	0.8-8.0	0.15-0.55												•	•	•			•					
	190616 EM	0.8-8.0	0.17-0.60											•	•	•			•						
Roughing	SNMG 120408 ET	2.0-7.0	0.25-0.70											•	•	•			•			•	•		
	120412 ET	2.0-7.0	0.30-0.70											•	•	•			•			•	•		
	190608 ET	3.0-9.0	0.30-0.75											•	•	•			•	•					
	190612 ET	3.0-9.0	0.35-0.75											•	•	•			•						
Finishing	SNMG 120404 FC	0.2-2.5	0.05-0.30										•												
	120408 FC	0.2-2.5	0.08-0.35										•												
	120412 FC	0.3-2.5	0.10-0.40										•												
Finishing	SNMG 090408 FG	0.5-2.0	0.10-0.35															•							
	090412 FG	0.5-2.0	0.15-0.40																•						
Finishing	SNMG 120404 FG	0.5-3.0	0.07-0.20			•							•						•						
	120408 FG	0.7-3.0	0.10-0.25	•	•								•	•											
Finishing	SNMG 090412 FM	0.35-2.0	0.15-0.40															•							
Roughing	SNMG 120408 KT	0.38-7.0	0.19-0.53				•	•	•																
	120412 KT	0.50-7.0	0.28-0.70				•	•	•																
	120416 KT	0.75-7.0	0.30-0.75				•	•																	
	150612 KT	0.6-8.5	0.30-0.75				•	•																	
	150616 KT	0.9-8.5	0.30-0.85				•	•																	
	190616 KT	1.3-12.0	0.30-0.85				•	•																	

• : Standard items







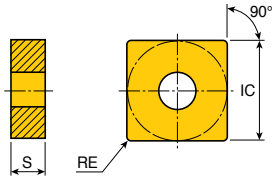



A77, A78, A128,
A129, A177, A179,
A210, A243

Negative square inserts



Size	Dimension (mm)		
	IC	S	RE
09	9.52	4.76	0.4-1.2
12	12.7	4.76	0.4-1.2
15	15.88	6.35	0.8
19	19.05	6.35	1.6

Insert	Designation	ap (mm)	Feed (mm/rev)	Cermat	CVD coated								PVD coated										
				PV3010	CT3000	TT3005	TT7015	TT7025	TT8105B	TT8115B	TT8125B	TT8135B	TT9215	TT9225	TT9235	TT15100	TT17100	TT5080	TT8020	TT9080	TT3010	TT3020	TT9020
 Medium	SNMG 120408 MC	0.7-3.5	0.12-0.35								●	●		●		●							
	120412 MC	0.7-3.5	0.15-0.40								●			●									
 Medium	SNMG 120408 MGP	0.5-5.0	0.15-0.50								●	●											
 Medium	SNMG 120408 MGS	1.0-4.0	0.15-0.40			●														●	●	●	
	120412 MGS	1.3-4.0	0.17-0.40			●														●	●	●	
	190616 MGS	1.5-8.0	0.17-0.60			●														●	●	●	
 Medium	SNMG 090404 MK	0.7-3.0	0.17-0.40										●	●									
 Medium	SNMG 120408 ML	1.0-3.5	0.12-0.35								●	●		●		●							●
	120412 ML	1.0-3.5	0.15-0.35								●	●		●									
 Medium	SNMG 090404 MM	0.4-3.0	0.15-0.45											●									
	090412 MM	0.7-3.0	0.23-0.50										●										
 Type B Medium	SNMG 120404 MP ✓	0.8-4.0	0.10-0.30								●	●		●		●							
	120408 MP	1.0-4.0	0.12-0.40								●	●		●		●		●	●	●			
	120412 MP	1.3-4.0	0.15-0.40								●	●		●									
	150608 MP	1.5-6.0	0.25-0.60								●			●									
 Medium	SNMG 090404 MT	0.8-3.0	0.10-0.35										●										
	090408 MT	1.0-3.0	0.15-0.45										●										

 A77, A78, A128,
A129, A177, A179,
A210, A243

✓ Marked: Type B chip breaker

●: Standard items

Negative square inserts

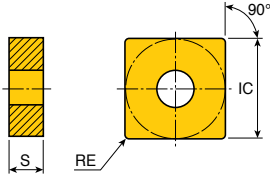

Size	Dimension (mm)		
	IC	S	RE
09	9.52	4.76	0.8-1.2
12	12.7	4.76	0.4-1.6
15	15.88	6.35	1.2
19	19.05	6.35	0.8-2.4
25	25.4	7.94-9.52	2.4-3.2

Insert	Designation	ap (mm)	Feed (mm/rev)	Coating																						
				Cermet		CVD coated								PVD coated												
				PV3010	CT3000	TT3005	TT7005	TT7015	TT7025	TT8105B	TT8115B	TT8125B	TT8135B	TT9215	TT9225	TT9235	TT5100	TT7100	TT5080	TT8020	TT9080	TT3010	TT3020	TT9020	K10	
 Type B Medium	SNMG 120404 MT ✓	1.0-5.0	0.12-0.40	●							●						●									
	120408 MT	1.2-5.0	0.17-0.55	●		●	●	●		●	●			●	●	●			●	●						
	120412 MT	1.5-5.0	0.20-0.55				●				●	●			●		●			●	●					
	150612 MT ✓	2.0-7.0	0.30-0.65									●	●													
	190608 MT	3.0-8.0	0.17-0.55									●				●										
 Medium	SNMG 190612 MT	3.0-8.0	0.20-0.55								●			●	●	●				●						
	SNMG 090408 PC	0.5-3.0	0.15-0.40									●														
 Medium	SNMG 090412 PC	0.6-3.0	0.18-0.50														●									
	SNMG 120404 PC	0.4-5.0	0.12-0.40									●														
	120408 PC	0.5-5.0	0.15-0.50									●	●		●	●					●					
 Type B Roughing	SNMG 120412 RT	2.5-6.0	0.30-0.70			●	●			●	●						●									
	120416 RT	2.5-6.0	0.40-0.70			●	●			●	●					●										
	150612 RT	3.0-7.0	0.30-0.70				●			●	●															
	190612 RT	3.0-9.0	0.30-0.75							●	●	●		●	●	●				●	●					
	190616 RT ✓	3.0-9.0	0.40-0.90							●	●	●		●	●	●				●	●					
	250724 RT	5.0-12.0	0.40-1.00																							
	250924 RT	5.0-12.0	0.40-1.00										●													
	SNMM 250924 EH	2.8-18.0	0.45-1.20												●	●	●									
 Roughing	SNMM 190612 HT	4.0-9.0	0.35-0.90								●	●														
	190616 HT	4.0-9.0	0.45-1.00								●	●						●								
	190624 HT	4.0-9.0	0.55-1.20								●															
	250724 HT	5.0-12.0	0.55-1.30								●	●		●	●	●										
	250924 HT	5.0-12.0	0.55-1.30								●								●							
	250932 HT	5.0-13.0	0.65-1.30									●														

A77, A78, A128,
 A129, A177, A179,
 A210, A243

● ✓ Marked: Type B chip breaker

●: Standard items

Negative triangular inserts

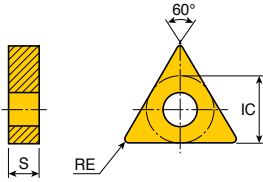

Size	Dimension (mm)		
	IC	S	RE
13	7.94	4.76	0.2-1.2
16	9.52	4.76	0.4-1.6
22	12.7	4.76	0.4-1.6

Insert	Designation	ap (mm)	Feed (mm/rev)	Cermet		CVD coated										PVD coated										
				PV3010	CT3000	TT3005	TT7005	TT7015	TT7025	TT8105B	TT8115B	TT8125B	TT8135B	TT9215	TT9225	TT9235	TT15100	TT17100	TT15080	TT18020	TT19080	TT13010	TT13020	TT19020	K10	
 Left hand Medium	TNGG 130402 L	0.8-3.5	0.10-0.30	●																						
	130402 R	0.8-3.5	0.10-0.30	●																						
	130404 L	1.0-3.5	0.12-0.30	●																						
	130404 R	1.0-3.5	0.12-0.30	●																						
	130408 L	1.3-3.5	0.15-0.35	●																						
	130408 R	1.3-3.5	0.15-0.35	●																						
 Left hand Medium	TNGG 160404 L	1.0-3.5	0.12-0.30	●						●																
	160404 R	1.0-3.5	0.12-0.30	●						●				●												
	160408 L	1.3-3.5	0.15-0.35	●																						
	160408 R	1.3-3.5	0.15-0.35	●																						
	220404 L	1.0-5.0	0.12-0.30	●																						
	220404 R	1.0-5.0	0.12-0.30	●																						
	220408 L	1.3-5.0	0.15-0.35	●																						
	220408 R	1.3-5.0	0.15-0.35	●																						
 Roughing	TNMA 160404	1.0-4.0	0.15-0.30							●	●	●														
	160408	1.0-4.0	0.15-0.40							●	●	●														
	160412	1.5-4.5	0.20-0.50								●	●														
	160416	1.0-4.5	0.20-0.50							●																
	220404	1.5-5.0	0.15-0.30																							
	220408	1.5-5.0	0.15-0.40																							
	220412	1.5-5.0	0.20-0.50								●	●														
	220416	2.0-5.0	0.20-0.61																							
 Medium	TNMG 130404	0.5-3.5	0.10-0.45							●	●															
	130408	0.5-3.5	0.10-0.50							●	●															
	130412	0.5-3.5	0.10-0.55							●	●															

A59, A65, A79, A80, A101, A130, A143,
 A144, A177, A180, A203, A204, A211,
 A222, A226, A244, A245, A248

●: Standard items



Negative triangular inserts

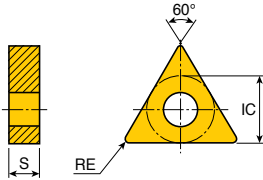

Size	Dimension (mm)		
	IC	S	RE
13	7.94	4.76	0.4-1.2
16	9.52	4.76	0.4-1.2
22	12.7	4.76	0.4-1.2

Insert	Designation	ap (mm)	Feed (mm/rev)	Coating																					
				Cermet			CVD coated							PVD coated			K10								
				PV3010	CT3000	TT3005	TT7005	TT7015	TT7025	TT8105B	TT8115B	TT8125B	TT8135B	TT9215	TT9235	TT15100		TT7100	TT15080	TT18020	TT19080	TT13010	TT13020	TT19020	
	TNMG 160404 L-FS	0.8-3.0	0.15-0.30	●									●			●									
	160404 R-FS	0.8-3.0	0.15-0.30	●									●			●			●						
	160408 L-FS	1.0-3.5	0.20-0.40											●											
	160408 R-FS	1.0-3.5	0.20-0.40											●			●		●						
	TNMG 130404 FT	0.25-2.5	0.07-0.30								●	●	●			●									
	130408 FT	0.3-2.5	0.10-0.40								●	●	●			●									
	130412 FT	0.35-2.5	0.15-0.50								●	●	●			●									
	TNMG 160408 KT	0.34-6.2	0.17-0.42				●	●	●																
	160412 KT	0.45-6.3	0.20-0.56				●	●																	
	220408 KT	0.38-7.0	0.19-0.53				●	●																	
	220412 KT	0.5-7.0	0.25-0.70				●	●																	
	TNMG 160408 MC	0.7-3.5	0.17-0.40								●	●				●									
	TNMG 160408 MGP	0.5-4.5	0.15-0.50								●	●													
	160412 MGP	0.6-4.5	0.17-0.55								●	●													
	TNMG 130404 MK	0.7-3.0	0.17-0.40												●	●		●	●						
	130408 MK	1.0-3.0	0.20-0.45												●	●		●	●						
	130412 MK	1.2-3.0	0.23-0.50												●	●		●	●						
	TNMG 160404 ML	0.8-3.5	0.10-0.30								●	●				●		●	●						
	160408 ML	1.0-3.5	0.12-0.35								●	●	●			●		●	●						
	160412 ML	1.5-3.5	0.15-0.35													●									
	220404 ML	1.0-4.0	0.10-0.30													●								●	
	220408 ML	1.0-4.0	0.12-0.35									●				●								●	

● : Standard items

A59, A65, A79, A80, A101, A130, A143, A144, A177, A180, A203, A204, A211, A222, A226, A244, A245, A248

VNGG VNGX VNMG



Negative 35° rhombic inserts

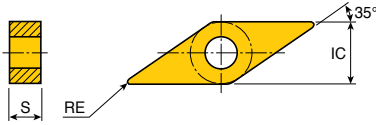

Size	Dimension (mm)		
	IC	S	RE
13	7.94	4.76	0.1-0.8
16	9.52	4.76	0.1-1.2

Insert	Designation	ap (mm)	Feed (mm/rev)	Cermet		CVD coated							PVD coated											
				PV3010	CT3000	TT3005	TT7005	TT7015	TT8115B	TT8125B	TT8135B	TT9215	TT9235	TT5100	TT7100	TT5080	TT8020	TT9080	TT3010	TT3020	TT9020	TT4410	TT4430	K10
Medium	VNGG 160401 ML	0.1-1.0	0.03-0.10																					•
	160402 ML	0.2-1.2	0.05-0.15											•										•
	160404 ML	0.8-3.0	0.10-0.27											•										•
	160408 ML	0.8-3.5	0.10-0.30																					
Finishing For Swiss	VNGX 130401M FS-F	0.2-1.0	0.03-0.12																				•	•
	130402M FS-F	0.2-1.0	0.04-0.12																				•	•
Medium	VNGX 130401 ML	0.1-1.0	0.03-0.10																					•
	130402 ML	0.2-1.2	0.05-0.15																					
	130404 ML	0.5-1.5	0.05-0.20																					
Medium	VNMG 160404	1.0-3.0	0.17-0.40				•	•	•					•										
	160408	1.5-3.0	0.17-0.50				•	•	•					•										
	160412	1.5-3.0	0.20-0.50				•	•	•															
Finishing	VNMG 160404 EA	0.1-1.5	0.05-0.20											•	•		•	•	•	•				
	160408 EA	0.2-2.5	0.08-0.30						•					•				•	•	•				
Medium	VNMG 160408 EM	0.8-3.5	0.13-0.50																					
Finishing	VNMG 160408 FA	0.3-2.0	0.05-0.25																					
Finishing	VNMG 130404 FC #	0.5-1.5	0.08-0.20																					
	130408 FC #	0.5-2.0	0.10-0.23																					
	160404 FC	0.3-2.5	0.05-0.30																					
	160408 FC	0.3-2.5	0.08-0.35																					



A60, A61, A66, A67,
A106, A107, A132-A135, A180,
A229, A231, A254

• # Marked: Insert with screw hole

•: Standard items

Negative 35° rhombic inserts

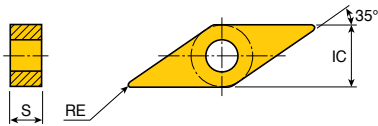

Size	Dimension (mm)		
	IC	S	RE
13	7.94	4.76	0.4-0.8
16	9.52	4.76	0.4-1.2

Insert	Designation	ap (mm)	Feed (mm/rev)	Coating																					
				Cermet		CVD coated								PVD coated			K10								
				PV3010	CT3000	TT3005	TT7005	TT7015	TT7025	TT8105B	TT8115B	TT8125B	TT8135B	TT9215	TT9225	TT9235		TT15100	TT17100	TT15080	TT18020	TT19080	TT13010	TT13020	TT19020
Finishing	VNMG 130404 FG #	0.5-1.5	0.08-0.20	●							●	●					●		●						
	130408 FG #	0.5-2.0	0.10-0.23	●							●	●													
	160404 FG	0.5-2.0	0.08-0.20	●	●						●	●	●		●		●		●	●					
	160408 FG	0.5-2.0	0.10-0.23	●	●						●	●	●				●		●						
Finishing	VNMG 160404 FLP	0.2-1.5	0.08-0.30								●	●													
	160408 FLP	0.3-1.5	0.10-0.30								●	●													
	160412 FLP	0.4-1.5	0.12-0.30								●	●													
Finishing	VNMG 160404 FX	0.2-2.0	0.05-0.20	●							●	●													
	160408 FX	0.2-2.0	0.07-0.20	●							●	●	●												
	160412 FX	0.2-2.0	0.10-0.23								●	●													
Medium	VNMG 160408 MGP	0.5-3.0	0.17-0.36								●	●													
 Type B Medium	VNMG 130404 MT #	0.8-2.5	0.15-0.36	●			●	●		●							●								
	130408 MT #	1.0-2.5	0.17-0.36	●		●				●	●						●								
	160404 MT ✓	0.8-3.0	0.15-0.36	●						●	●	●				●			●						
	160408 MT	1.0-2.5	0.17-0.36	●		●	●	●		●	●	●				●	●	●	●	●					
Medium	VNMG 160404 PC	0.4-3.0	0.15-0.36								●	●	●	●											
	160408 PC	0.5-3.0	0.17-0.36								●	●	●												
Medium	VNMM 160404 ML	0.8-3.0	0.10-0.27																						●
	160408 ML	1.0-3.0	0.12-0.32														●								●

A66, A67, A107, A132, A180, A229, A231

● ✓ Marked: Type B chip breaker
 ● # Marked: Insert with screw hole
 ● : Standard items

Negative 35° rhombic inserts

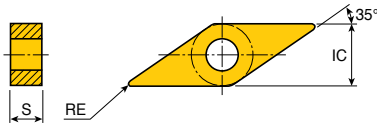

Size	Dimension (mm)		
	IC	S	RE
13	7.94	4.76	0.2-1.2

Insert	Designation	ap (mm)	Feed (mm/rev)	Cermat		CVD coated										PVD coated									
				PV3010	CT3000	TT3005	TT7005	TT7015	TT7025	TT8105B	TT8115B	TT8125B	TT8135B	TT9215	TT9225	TT9235	TT5100	TT7100	TT5080	TT8020	TT9080	TT3010	TT3020	TT9020	K10
Finishing	VNMX 130404 FG	0.5-2.0	0.08-0.20	●																					
	130408 FG	0.5-2.0	0.10-0.23	●																					
Finishing	VNMX 130404 FM	0.25-1.5	0.07-0.30	●						●	●	●	●		●		●		●						
	130408 FM	0.3-1.5	0.10-0.35	●						●	●	●	●		●		●		●						
Finishing	VNMX 130402 FS	0.2-1.0	0.05-0.20	●	●							●	●												
	130404 FS	0.25-1.0	0.07-0.20	●	●							●	●												
	130408 FS	0.5-1.0	0.10-0.23	●	●							●	●												
Finishing	VNMX 130404 FX	0.2-2.0	0.05-0.20	●	●							●	●												
	130408 FX	0.2-2.0	0.07-0.20	●	●							●	●												
Medium	VNMX 130404 MK	0.7-3.0	0.17-0.35												●	●		●		●					
	130408 MK	1.0-3.0	0.20-0.40			●												●	●	●	●				
Medium	VNMX 130404 MT	0.8-3.0	0.15-0.36									●	●	●	●		●		●		●				
	130408 MT	1.0-3.0	0.17-0.36					●	●			●	●	●	●		●		●		●				
	130412 MT	1.5-3.0	0.20-0.40					●	●			●	●	●	●		●		●		●				
Medium	VNMX 130404 PC	0.4-3.0	0.15-0.36									●	●	●	●		●		●		●				
	130408 PC	0.5-3.0	0.17-0.36									●	●	●	●		●		●		●				
	130412 PC	1.0-3.0	0.20-0.40									●	●	●	●		●		●		●				

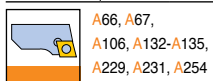

●: Standard items

Negative 80° trigon inserts

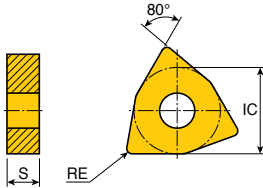

Size	Dimension (mm)		
	IC	S	RE
06	9.52	4.76	0.4-1.2
08	12.7	4.76	0.4-1.6

Insert	Designation	ap (mm)	Feed (mm/rev)	Coating																					
				Cermat			CVD coated							PVD coated			K10								
				PV3010	CT3000	TT3005	TT7005	TT7015	TT7025	TT8105B	TT8115B	TT8125B	TT8135B	TT9215	TT9225	TT9235		TT15100	TT7100	TT15080	TT18020	TT19080	TT13010	TT13020	TT19020
Roughing	WNMA 060408	1.0-4.0	0.15-0.70					●																	
	060412	1.5-4.0	0.20-0.80				●																		
	080408	1.0-5.0	0.15-0.70				●	●																	
	080412	1.5-5.0	0.20-0.80				●	●																	
	080416	1.5-5.0	0.20-0.80				●	●																	
Finishing	WNMG 080404 EA	0.1-1.5	0.05-0.20																●		●				
	080408 EA	0.1-1.5	0.10-0.40											●	●	●			●						
Medium	WNMG 060408 EM	0.8-3.0	0.13-0.50												●				●		●				
	060412 EM	0.8-3.0	0.15-0.55											●	●	●			●		●				
	080404 EM	0.8-4.0	0.10-0.45											●	●	●			●		●				
	080408 EM	0.8-4.0	0.12-0.45											●	●	●			●		●				
	080412 EM	0.8-4.0	0.12-0.45											●	●	●			●		●				
Roughing	WNMG 060408 ET	0.8-4.0	0.15-0.50											●	●	●			●		●				
	060412 ET	0.8-4.0	0.15-0.50											●	●	●			●		●				
	080408 ET	0.8-4.5	0.15-0.55											●	●				●						
	080412 ET	0.8-4.5	0.20-0.50											●	●				●						
Finishing	WNMG 060404 FC	0.5-2.0	0.07-0.20									●	●		●										
	080404 FC	0.5-2.0	0.07-0.20								●	●			●										
	080408 FC	0.5-2.0	0.07-0.20								●	●	●	●	●	●									
	080412 FC	0.5-2.0	0.10-0.25									●													
Finishing	WNMG 060404 FG	0.5-2.0	0.07-0.20	●	●						●	●					●								
	060408 FG	0.7-2.0	0.10-0.25	●	●						●														
	080404 FG	0.5-2.0	0.07-0.20	●	●						●	●	●				●		●						
	080408 FG	0.7-2.0	0.10-0.25	●	●						●	●					●								

● : Standard items

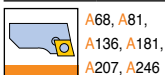

A68, A81,
A136, A181,
A207, A246

Negative 80° trigon inserts

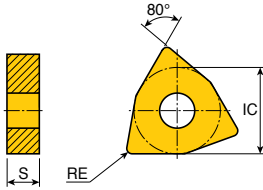

Size	Dimension (mm)		
	IC	S	RE
06	9.52	4.76	0.4-1.2
08	12.7	4.76	0.8-1.6

Insert	Designation	ap (mm)	Feed (mm/rev)	Cermet		CVD coated										PVD coated					K10			
				PV3010	CT3000	TT3005	TT7005	TT7015	TT7025	TT8105B	TT8115B	TT8125B	TT8135B	TT9215	TT9225	TT9235	TT15100	TT17100	TT15080	TT18020		TT19080	TT3010	TT3020
 Type B Medium	WNMG 060404 MT	1.0-3.0	0.12-0.40				●	●		●	●		●	●		●	●		●	●				
	060408 MT	1.2-3.0	0.15-0.45				●	●		●	●		●	●		●	●		●	●				
	060412 MT	1.5-3.0	0.23-0.50							●														
	080404 MT ✓	1.0-4.0	0.12-0.40		●		●	●		●	●		●	●		●	●		●	●				
	080408 MT	1.2-4.0	0.17-0.55		●		●	●		●	●		●	●		●	●		●	●				
	080412 MT	1.5-4.0	0.25-0.55				●	●		●	●		●	●		●	●		●	●				
	080416 MT	1.5-4.0	0.25-0.55				●	●		●	●								●					
 Medium	WNMG 060408 PC	0.5-4.0	0.15-0.50							●	●													
	060412 PC	0.6-4.0	0.17-0.50							●	●													
	080408 PC	0.5-4.0	0.15-0.50							●	●		●	●		●	●		●	●				
	080412 PC	0.6-4.0	0.17-0.50							●	●		●	●		●	●		●	●				
	080416 PC	0.8-4.0	0.20-0.50							●	●													
 Roughing	WNMG 080408 RGP	2.5-4.0	0.25-0.70							●	●													
	080412 RGP	2.5-4.0	0.25-0.70							●	●													
	080416 RGP	2.5-4.0	0.30-0.75							●	●													
 Roughing	WNMG 080408 RT	2.5-4.0	0.25-0.70				●	●		●	●	●	●	●	●	●								
	080412 RT	2.5-4.0	0.25-0.70				●	●	●	●	●			●	●									
	080416 RT	2.5-4.0	0.30-0.75				●			●	●													
 wiper Finishing	WNMG 080408 WS	0.5-2.0	0.07-0.35				●			●	●													



● ✓ Marked: Type B chip breaker ● : Standard items





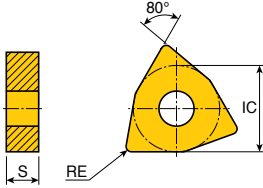

WNUMG WNUMX



Negative 80° trigon inserts



Size	Dimension (mm)		
	IC	S	RE
04	7	3.18	0.4-0.8
06	9.52	4.76	0.4-1.2
08	12.7	4.76	0.8-1.2

Insert	Designation	ap (mm)	Feed (mm/rev)	Cermet		CVD coated										PVD coated									
				PV3010	CT3000	TT3005	TT7005	TT7015	TT7025	TT8105B	TT8115B	TT8125B	TT8135B	TT9215	TT9225	TT9235	TT15100	TT7100	TT5080	TT8020	TT9080	TT3010	TT3020	TT9020	K10
 Medium	WNUMG 060408 WT	0.7-3.5	0.15-0.60																						
	060412 WT	0.7-3.5	0.20-0.80																						
	080408 WT	1.0-4.0	0.15-0.60																						
	080412 WT	1.0-4.0	0.20-0.80																						
 Medium	WNUMX 060404 EM	0.4-3.0	0.10-0.35																						
	060408 EM	0.5-3.0	0.13-0.40																						
	060412 EM	0.7-3.0	0.15-0.40																						
 Finishing	WNUMX 060404 FG	0.2-2.0	0.07-0.30																						
 Finishing	WNUMX 040304 FGP	0.3-2.0	0.05-0.25																						
	040308 FGP	0.4-2.0	0.08-0.25																						
 Finishing	WNUMX 060404 FM	0.25-2.0	0.07-0.30																						
	060408 FM	0.3-2.0	0.10-0.35																						
	060412 FM	0.35-2.0	0.15-0.40																						
 Finishing	WNUMX 060404 FS	0.25-1.5	0.07-0.30																						
	060408 FS	0.5-1.5	0.10-0.30																						

●: Standard items



A62, A68, A81, A111,
A136, A137, A205, A207,
A234, A246, A261

Negative 80° trigon inserts

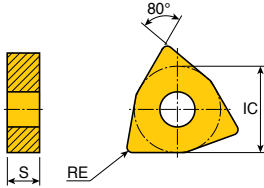

Size	Dimension (mm)		
	IC	S	RE
06	9.52	4.76	0.4-1.2

Insert	Designation	ap (mm)	Feed (mm/rev)	Cermet		CVD coated										PVD coated				K10						
				PV3010	CT3000	TT3005	TT7005	TT7015	TT7025	TT8105B	TT8115B	TT8125B	TT8135B	TT9215	TT9225	TT9235	TT15100	TT7100	TT5080		TT8020	TT9080	TT3010	TT3020	TT9020	
WNMX 060404 MK		0.7-3.0	0.17-0.40																							
	060408 MK	1.0-3.0	0.20-0.45																							
	060412 MK	1.2-3.0	0.23-0.50																							
WNMX 060404 MM		0.4-3.0	0.15-0.45																							
	060408 MM	0.5-3.0	0.20-0.50																							
	060412 MM	0.7-3.0	0.23-0.50																							
WNMX 060404 MT		0.8-3.0	0.10-0.35																							
	060408 MT	1.0-3.0	0.15-0.45																							
	060412 MT	1.2-3.0	0.20-0.55																							
WNMX 060404 PC		0.4-3.0	0.10-0.30																							
	060408 PC	0.5-3.0	0.15-0.40																							
	060412 PC	0.6-3.0	0.18-0.50																							
WNMX 060404 WA		0.25-2.5	0.08-0.25																							
	060408 WA	0.25-3.0	0.10-0.40																							
	060412 WA	0.4-3.0	0.20-0.50																							

● : Standard items

A136, A137,
A205, A234, A246

Negative 70° rhombic inserts

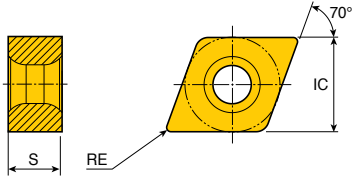

Size	Dimension (mm)		
	IC	S	RE
09	8.7	4.76	0.4
11	11.11	5.56	0.4-1.2

Insert	Designation	ap (mm)	Feed (mm/rev)	CVD coated											PVD coated										
				Cermet	CVD coated											PVD coated									
				PV3010	CT3000	TT3005	TT7005	TT7015	TT7025	TT8105B	TT8115B	TT8125B	TT8135B	TT9215	TT9225	TT9235	TT5100	TT7100	TT5080	TT8020	TT9080	TT3010	TT3020	TT9020	K10
 Finishing	XNMG 090404 FLP	0.20-1.50	0.07-0.30							●	●	●													
 Finishing	XNMG 110504 FGP	0.25-2.00	0.07-0.30							●	●	●													
	110508 FGP	0.30-2.00	0.10-0.35							●	●	●													
	110512 FGP	0.35-2.00	0.15-0.40							●	●														
 Medium	XNMG 110508 MLP	0.50-3.50	0.10-0.40							●	●	●													
	110512 MLP	0.60-3.50	0.15-0.50							●	●	●													



A138-A140,
A206, A236,
A247, A262

●: Standard items

YNMG

Negative 25° rhombic inserts

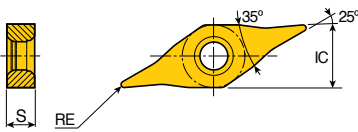

Size	Dimension (mm)		
	IC	S	RE
13	7.94	4.76	0.4-0.8

Insert	Designation	ap (mm)	Feed (mm/rev)	CVD coated											PVD coated											
				Cermet	CVD coated											PVD coated										
				PV3010	CT3000	TT3005	TT7005	TT7015	TT7025	TT8105B	TT8115B	TT8125B	TT8135B	TT9215	TT9225	TT9235	TT5100	TT7100	TT5080	TT8020	TT9080	TT3010	TT3020	TT9020	K10	
 Finishing	YNMG 130404 FS	0.3-1.0	0.08-0.20	●	●					●										●	●					
	130408 FS	0.5-1.5	0.08-0.25	●	●					●										●						



A60, A61,
A106, A132-A135,
A229, A231, A254

●: Standard items

Negative triangular inserts

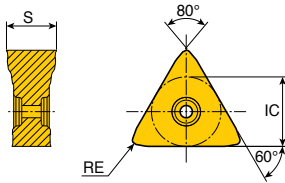

Size	Dimension (mm)		
	IC	S	RE
21	12.5	9	0.8

Insert	Designation	BWT ⁽¹⁾		FWT ⁽²⁾		CVD coated						PVD coated		K10											
		ap (mm)	Feed (mm/rev)	ap (mm)	Feed (mm/rev)	TT3005	TT7005	TT7015	TT7025	TT8105B	TT8115B	TT8125B	TT8135B		TT9215	TT9225	TT9235	TT5080	TT8020	TT9080	TT3010	TT3020	TT9020		
 Medium	TNMV 210908-BM	0.7-2.0	0.60-1.20	0.5-3.5	0.20-0.60						●	●													



A131

- (1) BWT: Backward turning
- (2) FWT: Forward turning

● : Standard items

XNMV

Negative 70° rhombic inserts

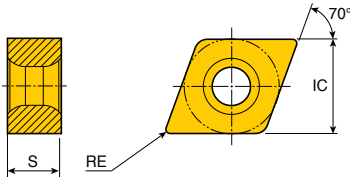

Size	Dimension (mm)		
	IC	S	RE
11	11.11	5.56	0.8

Insert	Designation	BWT ⁽¹⁾		FWT ⁽²⁾		CVD coated						PVD coated		K10											
		ap (mm)	Feed (mm/rev)	ap (mm)	Feed (mm/rev)	TT3005	TT7005	TT7015	TT7025	TT8105B	TT8115B	TT8125B	TT8135B		TT9215	TT9225	TT9235	TT5080	TT8020	TT9080	TT3010	TT3020	TT9020		
 Medium	XNMV 110508L-BM	0.5-1.8	0.50-0.80	0.5-3.5	0.10-0.40																				
	110508R-BM	0.5-1.8	0.50-0.80	0.5-3.5	0.10-0.40						●	●													
 Medium For Cast Iron	XNMV 110508-BK	0.5-1.8	0.50-0.80	0.5-3.5	0.10-0.40	●	●																		



A138-A139,
A206, A236,
A247, A262



- (1) BWT: Backward turning
- (2) FWT: Forward turning
- Apply L insert to L holder and R boring bar
- Apply R insert to R holder and L boring bar

● : Standard items

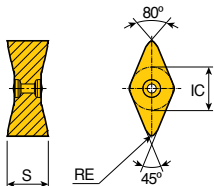
Negative rhombic inserts with 80° corner angle



Size	Dimension (mm)		
	IC	S	RE
14	10.5	10	0.8

Insert	Designation	BWT ⁽¹⁾		FWT ⁽²⁾		CVD coated								PVD coated									
		ap (mm)	Feed (mm/rev)	ap (mm)	Feed (mm/rev)	TT3005	TT7005	TT7015	TT7025	TT8105B	TT8115B	TT8125B	TT8135B	TT9215	TT9225	TT9235	TT5080	TT8020	TT9080	TT3010	TT3020	TT9020	K10
 Medium	ZNMV 141008-BM	0.5-2.5	0.40-1.00	0.5-2.0	0.20-0.60					●	●	●											
 Medium	ZNMV 141008-BS	0.5-2.5	0.50-1.00	1.0-2.0	0.20-0.40	●				●	●	●								●	●		



A141, A142
A182

●⁽¹⁾ BWT: Backward turning
●⁽²⁾ FWT: Forward turning

●: Standard items

ZNMV Y-BF

Negative rhombic inserts with 35° corner angle

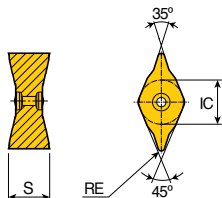

Size	Dimension (mm)		
	IC	S	RE
14	10.5	10	0.8

Insert	Designation	BWT ⁽¹⁾		FWT ⁽²⁾		CVD coated								PVD coated									
		ap (mm)	Feed (mm/rev)	ap (mm)	Feed (mm/rev)	TT3005	TT7005	TT7015	TT7025	TT8105B	TT8115B	TT8125B	TT8135B	TT9215	TT9225	TT9235	TT5080	TT8020	TT9080	TT3010	TT3020	TT9020	K10
 Finishing	ZNMV 141008Y-BF	0.25-1.5	0.20-0.50	0.25-1.0	0.20-0.35	●							●	●	●								



A141, A142
A182

●⁽¹⁾ BWT: Backward turning
●⁽²⁾ FWT: Forward turning

●: Standard items

Positive 7° clearance 80° rhombic inserts

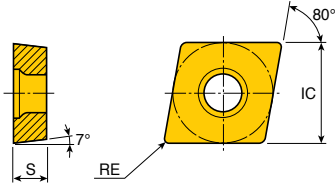

Size	Dimension (mm)		
	IC	S	RE
06	6.35	2.38	0.03-0.8
09	9.52	3.97	0.03-0.8

Insert	Designation	ap (mm)	Feed (mm/rev)	Cermet		PVD coated							Uncoated					
				PV3010	CT3000	TT5080	TT8020	TT9080	TT3010	TT3020	TT9020	TT4410	TT4430	P20	K10			
 Right hand Finishing	CCET 0602003 L-GF	0.1-1.5	0.02-0.15															
	0602003 R-GF	0.1-1.5	0.02-0.15															
	060201 L-GF	0.2-1.5	0.02-0.15															
	060201 R-GF	0.2-1.5	0.02-0.15															
	060202 L-GF	0.3-1.5	0.03-0.17															
	060202 R-GF	0.3-1.5	0.03-0.17															
	060204 L-GF	0.3-1.5	0.05-0.20															
	060204 R-GF	0.3-1.5	0.05-0.20															
	060208 L-GF	0.4-1.5	0.07-0.22															
	060208 R-GF	0.4-1.5	0.07-0.22															
	09T3003 L-GF	0.1-2.5	0.02-0.15															
	09T3003 R-GF	0.1-2.5	0.02-0.15															
	09T301 L-GF	0.2-2.5	0.02-0.15															
	09T301 R-GF	0.2-2.5	0.02-0.15															
	09T302 L-GF	0.3-2.5	0.03-0.17															
	09T302 R-GF	0.3-2.5	0.03-0.17															
	09T304 L-GF	0.3-2.5	0.05-0.20															
09T304 R-GF	0.3-2.5	0.05-0.20																
09T308 L-GF	0.4-2.5	0.07-0.22																
09T308 R-GF	0.4-2.5	0.07-0.22																
 Right hand Finishing	CCET 0602003 L-GW*	0.1-1.5	0.02-0.15															
	0602003 R-GW*	0.1-1.5	0.02-0.15															
	09T3003 L-GW*	0.1-2.5	0.02-0.15															
	09T3003 R-GW*	0.1-2.5	0.02-0.15															

A82-A84,
 A113, A183,
 A212, A213, A255

* Marked: Wiper inserts should be applied to
 CLCR/L...

●: Standard items

Positive 7° clearance 80° rhombic inserts

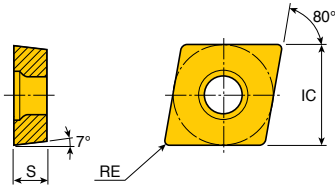

Size	Dimension (mm)		
	IC	S	RE
03	3.5	1.4	0.03-0.4
04	4.3	1.8	0.03-0.4
06	6.35	2.38	0.1-0.4
09	9.52	3.97	0.1-0.8
12	12.7	4.76	0.2-0.8

Insert	Designation	ap (mm)	Feed (mm/rev)	Cermet		PVD coated								Uncoated				
				PV3010	CT3000	TT5080	TT18020	TT9080	TT3010	TT3020	TT9020	TT4410	TT4430	P20	K10			
 Right hand Finishing	CCGT 0301003 L-FF	0.05-0.3	0.03-0.10															
	0301003 R-FF	0.05-0.3	0.03-0.10															
	030101 L-FF	0.08-0.4	0.03-0.12															
	030101 R-FF	0.08-0.4	0.03-0.12															
	030102 L-FF	0.1-0.4	0.03-0.15															
	030102 R-FF	0.1-0.4	0.03-0.15															
	030104 L-FF	0.1-0.4	0.05-0.20															
	030104 R-FF	0.1-0.4	0.05-0.20															
	0401003 L-FF	0.05-0.4	0.03-0.10															
	0401003 R-FF	0.05-0.4	0.03-0.10															
	040101 L-FF	0.1-0.5	0.03-0.12															
	040101 R-FF	0.1-0.5	0.03-0.12															
	040102 L-FF	0.1-0.5	0.03-0.15															
	040102 R-FF	0.1-0.5	0.03-0.15															
	040104 L-FF	0.1-0.5	0.05-0.20															
040104 R-FF	0.1-0.5	0.05-0.20																
 Medium For aluminum	CCGT 060202 FL	0.5-2.0	0.10-0.20														●	
	060204 FL	0.5-2.0	0.10-0.25															●
	09T301 FL	0.5-2.5	0.10-0.25															●
	09T302 FL	0.5-2.5	0.10-0.25															●
	09T304 FL	0.5-2.5	0.10-0.25															●
	09T308 FL	0.8-3.0	0.10-0.30															●
	120402 FL	0.5-2.5	0.10-0.25															●
	120404 FL	0.5-2.5	0.10-0.25															●
	120408 FL	1.0-3.5	0.10-0.30															●
 Finishing	CCGT 060201 SA	0.1-1.5	0.02-0.15															
	060202 SA	0.1-1.5	0.02-0.15															
	060204 SA	0.1-2.4	0.03-0.20															
	09T301 SA	0.1-2.5	0.02-0.15															
	09T302 SA	0.1-2.5	0.02-0.15															
	09T304 SA	0.1-2.5	0.03-0.20															
	09T308 SA	0.1-2.5	0.03-0.25															

● : Standard items

A82-A84, A113, A183, A212, A213, A255

Positive 7° clearance 80° rhombic inserts

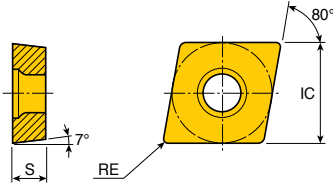

Size	Dimension (mm)		
	IC	S	RE
06	6.35	2.38	0.2
09	9.52	3.97	0.1-0.4

Insert	Designation	ap (mm)	Feed (mm/rev)	Cermet								PVD coated		Uncoated			
				PV3010	CT3000	TT5080	TT8020	TT9080	TT3010	TT3020	TT9020	TT4410	TT4430	P20	K10		
 Roughing For Swiss	CCGT 09T304M SH-F	0.7-3.5	0.07-0.17										●	●			
 Medium For Swiss	CCGT 060202M SM-F	0.2-1.5	0.02-0.12										●	●			
	09T301M SM-F	0.2-1.5	0.02-0.12											●	●		
	09T302M SM-F	0.2-1.5	0.02-0.12											●	●		
	09T304M SM-F	0.3-1.5	0.03-0.12											●	●		
 Finishing For Swiss	CCGT 060202M SL-F	0.02-0.2	0.02-0.10										●	●			
	09T301M SL-F	0.02-0.2	0.015-0.10											●	●		
	09T302M SL-F	0.02-0.2	0.02-0.10											●	●		

A82-A84,
 A113, A183,
 A212, A213, A255

● : Standard items

Positive 7° clearance 80° rhombic inserts

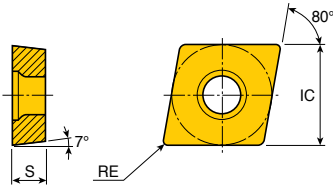

Size	Dimension (mm)		
	IC	S	RE
06	6.35	2.38	0.2-0.8
09	9.52	3.97	0.2-0.8
12	12.7	4.76	0.4-1.2

Insert	Designation	ap (mm)	Feed (mm/rev)	Coating																						
				Cermet		CVD coated										PVD coated										
				PV3010	CT3000	TT3005	TT7005	TT7015	TT7025	TT8105B	TT8115B	TT8125B	TT8135B	TT9215	TT9225	TT9235	TT15100	TT7100	TT5080	TT8020	TT9080	TT3010	TT3020	TT9020	K10	
Finishing	CCMT060202 FA	0.1-1.5	0.03-0.15	●	●										●	●	●	●	●	●						
	060204 FA	0.2-1.5	0.05-0.15	●	●						●					●	●	●	●	●	●					
	09T302 FA	0.1-2.0	0.03-0.15	●	●											●	●	●	●	●	●	●				
	09T304 FA	0.2-2.0	0.05-0.20	●	●							●						●	●	●	●	●				
	09T308 FA	0.3-2.0	0.08-0.25	●	●							●					●	●	●	●	●	●				
Type B Finishing	CCMT060204 FG	0.3-1.5	0.05-0.15	●	●		●	●			●	●			●	●	●	●	●	●	●	●	●	●	●	●
	09T304 FG	0.4-2.0	0.07-0.20	●	●	●	●	●			●	●			●	●	●	●	●	●	●	●	●	●	●	●
	09T308 FG	0.6-2.0	0.10-0.25	●	●	●	●	●			●	●			●	●	●	●	●	●	●	●	●	●	●	●
	120408 FG ✓	0.6-2.0	0.10-0.25	●								●					●	●	●	●	●	●	●	●	●	●
Medium	CCMT060202 FM	0.5-1.5	0.07-0.15								●	●					●	●	●	●						
	060204 FM	0.5-1.5	0.08-0.15								●	●					●	●	●	●						
	09T302 FM	0.5-2.0	0.07-0.20								●	●					●	●	●	●						
	09T304 FM	0.5-2.5	0.08-0.25								●	●					●	●	●	●						
	09T308 FM	0.8-2.5	0.10-0.25								●	●					●	●	●	●						
Type B Medium	CCMT060204 MT ✓	0.5-2.0	0.07-0.20	●	●		●	●			●	●			●	●	●	●	●	●	●	●	●	●	●	●
	060208 MT ✓	0.7-2.0	0.13-0.30	●	●		●	●			●	●			●	●	●	●	●	●	●	●	●	●	●	●
	09T304 MT	0.7-3.5	0.10-0.25	●	●		●	●	●			●	●			●	●	●	●	●	●	●	●	●	●	●
	09T308 MT	1.0-3.5	0.13-0.30	●	●		●	●	●			●	●			●	●	●	●	●	●	●	●	●	●	●
	120404 MT ✓	1.0-5.0	0.10-0.25	●	●		●	●			●	●					●	●	●	●	●	●	●	●	●	●
	120408 MT	1.3-5.0	0.13-0.30	●			●	●	●			●	●			●	●	●	●	●	●	●	●	●	●	●
	120412 MT	1.5-5.0	0.17-0.35				●	●				●	●				●	●	●	●	●	●	●	●	●	●
Medium	CCMT060204 PC	0.3-2.0	0.06-0.18								●	●	●		●	●					●					
	060208 PC	0.4-2.0	0.08-0.25								●	●	●		●	●					●					
	09T304 PC	0.35-3.0	0.08-0.25								●	●	●		●	●	●				●					
	09T308 PC	0.5-3.0	0.10-0.28								●	●	●		●	●	●				●					
	120404 PC	0.4-4.0	0.08-0.25								●	●	●		●	●	●				●					
	120408 PC	0.7-4.0	0.10-0.30								●	●	●		●	●	●				●					
	120412 PC	1.0-4.0	0.12-0.35								●	●	●		●	●	●	●			●					
Wiper Medium	CCMT09T308 WT *	0.7-3.0	0.10-0.40				●				●	●				●	●	●	●	●	●	●	●	●	●	

A82-A84,
 A113, A183,
 A212, A213, A255

● : Standard items
 ● ✓ : Marked: Type B chip breaker
 ● * : Marked: Wiper inserts should be applied to
 □ CLCR/L...

Positive 11° clearance 80° rhombic inserts

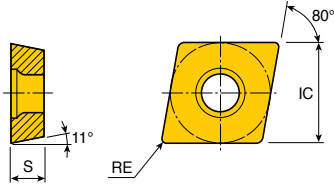

Size	Dimension (mm)		
	IC	S	RE
06	6.35	2.38	0.4-0.8
08	7.94	2.38	0.4-0.8
09	9.52	3.18-3.97	0.4-0.8

Insert	Designation	ap (mm)	Feed (mm/rev)	Cemet		CVD coated										PVD coated								
				PV3010	CT3000	TT3005	TT7015	TT7025	TT8105B	TT8115B	TT8125B	TT8135B	TT9215	TT9225	TT9235	TT15100	TT7100	TT5080	TT8020	TT9080	TT3010	TT3020	TT9020	K10
Finishing	CPMT 080204 FG	0.4-1.5	0.07-0.20	●																				
	080208 FG	0.6-1.5	0.10-0.25	●																				
	090304 FG	0.4-2.0	0.07-0.20	●																				
	090308 FG	0.6-2.0	0.10-0.25	●						●	●			●										
Medium	CPMT 080204 FM	0.5-2.0	0.08-0.20																					
	080208 FM	0.8-2.0	0.10-0.20																					
	090304 FM	0.5-2.5	0.08-0.25																					
	090308 FM	0.8-2.5	0.10-0.25																					
Medium	CPMT 060204 PC	0.3-2.0	0.06-0.18				●	●																
	060208 PC	0.4-2.0	0.08-0.25						●															
	090304 PC	0.45-3.0	0.08-0.25																					
	090308 PC	0.6-3.0	0.10-0.30																					
	09T304 PC	0.45-3.0	0.08-0.25																					●
	09T308 PC	0.6-3.0	0.10-0.30																					



A215, A216

●: Standard items

Positive 7° clearance 55° rhombic inserts

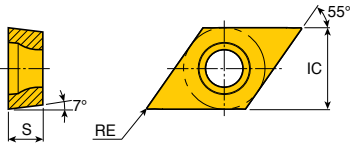

Size	Dimension (mm)		
	IC	S	RE
07	6.35	2.38	0.03-0.8
11	9.52	3.97	0.03-0.8

Insert	Designation	ap (mm)	Feed (mm/rev)	Cermet		PVD coated								Uncoated				
				PV3010	CT3000	TT5080	TT8020	TT9080	TT3010	TT3020	TT9020	TT4410	TT4430	P20	K10			
 Right hand Finishing	DCET 0702003 L-GF	0.2-1.5	0.01-0.15															
	0702003 R-GF	0.2-1.5	0.01-0.15															
	070201 L-GF	0.2-1.5	0.02-0.15															
	070201 R-GF	0.2-1.5	0.02-0.15															
	070202 L-GF	0.3-1.5	0.03-0.17															
	070202 R-GF	0.3-1.5	0.03-0.17															
	070204 L-GF	0.3-1.5	0.05-0.20															
	070204 R-GF	0.3-1.5	0.05-0.20															
	070208 L-GF	0.3-1.5	0.05-0.20															
	070208 R-GF	0.3-1.5	0.05-0.20															
	11T3003 L-GF	0.2-2.5	0.02-0.15															
	11T3003 R-GF	0.2-2.5	0.02-0.15															
	11T301 L-GF	0.2-2.5	0.02-0.15															
	11T301 R-GF	0.2-2.5	0.02-0.15															
	11T302 L-GF	0.3-2.5	0.03-0.17															
	11T302 R-GF	0.3-2.5	0.03-0.17															
	11T304 L-GF	0.3-2.5	0.05-0.20															
	11T304 R-GF	0.3-2.5	0.05-0.20															
11T308 L-GF	0.3-2.5	0.05-0.20																
11T308 R-GF	0.3-2.5	0.05-0.20																
 Right hand Finishing	DCET 0702003 L-GW*	0.1-1.5	0.02-0.15															
	0702003 R-GW*	0.1-1.5	0.02-0.15															
	11T3003 L-GW*	0.1-1.5	0.02-0.15															
	11T3003 R-GW*	0.1-1.5	0.02-0.15															

A87, A88, A91, A92, A114, A117, A119, A166, A171, A183, A217-A219, A257



• * Marked: Wiper inserts should be applied to
DJCR/L..., DUCR/L..., ZCR/L...

● : Standard items

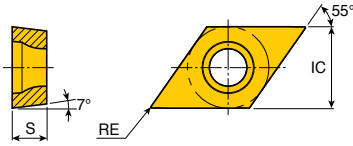
Positive 7° clearance 55° rhombic inserts



Size	Dimension (mm)		
	IC	S	RE
07	6.35	2.38	0.03-0.4
11	9.52	3.97	0.03-0.8

Insert	Designation	ap (mm)	Feed (mm/rev)	Cermet		PVD coated						Uncoated					
				PV3010	CT3000	TT5080	TT8020	TT9080	TT3010	TT3020	TT9020	TT4410	TT4430	P20	K10		
 Right hand Finishing	DCGT 0702003 L-FF	0.05-0.3	0.03-0.10														
	0702003 R-FF	0.05-0.3	0.03-0.10														
	070201 L-FF	0.08-0.4	0.03-0.12														
	070201 R-FF	0.08-0.4	0.03-0.12														
	070202 L-FF	0.1-0.4	0.03-0.15														
	070202 R-FF	0.1-0.4	0.03-0.15														
	070204 L-FF	0.1-0.4	0.05-0.20														
	070204 R-FF	0.1-0.4	0.05-0.20														
	11T3003 L-FF	0.05-0.4	0.03-0.10														
	11T3003 R-FF	0.05-0.4	0.03-0.10														
	11T301 L-FF	0.1-0.5	0.03-0.12														
	11T301 R-FF	0.1-0.5	0.03-0.12														
	11T302 L-FF	0.1-0.5	0.03-0.15														
	11T302 R-FF	0.1-0.5	0.03-0.15														
	11T304 L-FF	0.1-0.5	0.05-0.20														
	11T304 R-FF	0.1-0.5	0.05-0.20														
 Medium For aluminum	DCGT 070202 FL	0.5-2.0	0.05-0.20														
	070204 FL	0.5-2.5	0.05-0.25														
	11T302 FL	0.5-2.5	0.05-0.25														
	11T304 FL	0.5-2.5	0.05-0.25														
	11T308 FL	0.8-3.0	0.08-0.30														
 Finishing	DCGT 070201 SA	0.1-1.5	0.02-0.15														
	070202 SA	0.1-1.5	0.02-0.15														
	070204 SA	0.1-1.5	0.03-0.20														
	11T301 SA	0.1-2.5	0.01-0.05														
	11T302 SA	0.1-2.5	0.02-0.15														
	11T304 SA	0.1-2.5	0.03-0.20														
	11T308 SA	0.1-2.5	0.03-0.20														

 A87, A88, A91, A92, A114,
 A117, A119, A166, A171,
 A183, A217-A219, A257

● : Standard items

Positive 7° clearance 55° rhombic inserts

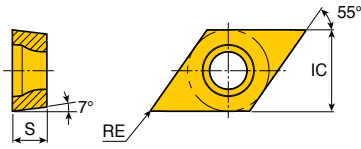

Size	Dimension (mm)		
	IC	S	RE
07	6.35	2.38	0.1-0.4
11	9.52	3.97	0.1-0.4

Insert	Designation	ap (mm)	Feed (mm/rev)	Cermet		PVD coated								Uncoated					
				PV3010	CT3000	TT5080	TT8020	TT9080	TT3010	TT3020	TT9020	TT4410	TT4430	P20	K10				
 Roughing For Swiss	DCGT 11T302M SH-E	0.7-3.5	0.05-0.15																
	11T302M SH-F	0.7-3.5	0.05-0.15																
	11T304M SH-F	0.7-3.5	0.07-0.17																
 Medium For Swiss	DCGT 070201M SM-F	0.2-1.5	0.02-0.12																
	070202M SM-F	0.2-1.5	0.02-0.12																
	070204M SM-F	0.2-1.5	0.03-0.12																
	11T301M SM-F	0.2-1.5	0.02-0.12																
	11T302M SM-F	0.2-1.5	0.02-0.12																
	11T304M SM-F	0.2-1.5	0.03-0.12																
 Finishing For Swiss	DCGT 070201M SL-F	0.02-0.25	0.015-0.10																
	070202M SL-F	0.02-0.25	0.02-0.10																
	11T301M SL-F	0.02-0.25	0.015-0.10																
	11T302M SL-F	0.02-0.25	0.02-0.10																

● : Standard items

A87, A88, A91, A92, A114,
 A117, A119, A166, A171,
 A183, A217-A219, A257

Positive 7° clearance 55° rhombic inserts

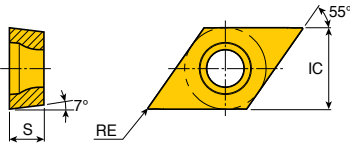

Size	Dimension (mm)		
	IC	S	RE
07	6.35	2.38	0.2-0.8
11	9.52	3.97	0.2-1.2

Insert	Designation	ap (mm)	Feed (mm/rev)	Coating																						
				Cermet		CVD coated							PVD coated													
				PV3010	CT3000	TT3005	TT7005	TT7015	TT7025	TT8105B	TT8115B	TT8125B	TT8135B	TT9215	TT9225	TT9235	TT5100	TT7100	TT5080	TT8020	TT9080	TT3010	TT3020	TT9020	K10	
Finishing	DCMT 070202 FA	0.1-1.5	0.03-0.15	●	●												●		●	●						
	070204 FA	0.2-1.5	0.05-0.20	●	●					●	●								●	●						
	11T302 FA	0.1-2.0	0.03-0.15	●	●									●			●		●	●						
	11T304 FA	0.2-2.0	0.05-0.20	●	●						●	●						●		●	●					
	11T308 FA	0.3-2.0	0.08-0.25	●	●						●	●						●		●	●					
Finishing	DCMT 070204 FG	0.4-1.5	0.07-0.20	●	●					●	●	●			●	●	●		●	●	●					
	070208 FG	0.4-2.0	0.07-0.20	●	●					●	●			●	●	●			●	●						
	11T304 FG	0.6-1.5	0.10-0.25	●	●	●	●			●	●	●		●	●	●			●	●	●	●	●	●	●	
	11T308 FG	0.6-2.0	0.10-0.25	●	●	●	●			●	●	●		●	●	●			●	●	●	●	●	●	●	
Medium	DCMT 070202 FM	0.5-1.5	0.07-0.20							●	●						●		●	●						
	070204 FM	0.5-1.5	0.08-0.20							●	●			●	●	●			●	●	●					
	070208 FM	0.8-1.5	0.10-0.20							●	●						●		●	●						
	11T302 FM	0.5-2.0	0.07-0.20							●	●						●		●	●						
	11T304 FM	0.5-2.0	0.08-0.20							●	●						●		●	●						
	11T308 FM	0.8-2.5	0.10-0.25							●	●						●		●	●						
Medium	DCMT 11T304 MT	0.7-3.0	0.10-0.25	●	●		●	●	●	●	●	●		●	●	●			●	●						
	11T308 MT	1.0-3.0	0.13-0.30	●		●	●	●	●	●	●			●	●	●			●	●	●					
	11T312 MT	1.5-3.0	0.17-0.35	●		●	●			●							●		●	●						
Medium	DCMT 070204 PC	0.3-2.0	0.06-0.18							●	●			●	●					●						
	070208 PC	0.4-2.0	0.08-0.25							●	●			●	●					●						
	11T304 PC	0.35-3.0	0.08-0.25							●	●	●		●	●					●						
	11T308 PC	0.5-3.0	0.10-0.28							●	●	●		●	●					●						
	11T312 PC	0.5-3.0	0.12-0.32							●	●			●	●					●						

- A87, A88, A91, A92, A114,
- A117, A119, A166, A171,
- A183, A217-A219, A257

●: Standard items



Positive 11° clearance 55° rhombic inserts

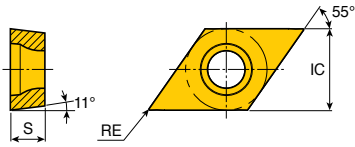

Size	Dimension (mm)		
	IC	S	RE
07	6.35	2.38	0.03-0.2
11	9.52	3.97	0.03-0.2

Insert	Designation	ap (mm)	Feed (mm/rev)	Cermet		PVD coated								Uncoated			
				PV3010	CT3000	TT5080	TT8020	TT9080	TT3010	TT3020	TT9020	TT4410	TT4430	P20	K10		
 Right hand Finishing	DPET 0702003 L-GF	0.2-1.5	0.01-0.15														
	0702003 R-GF	0.2-1.5	0.01-0.15									●					
	070201 L-GF	0.2-1.5	0.02-0.15									●					
	070201 R-GF	0.2-1.5	0.02-0.15									●					
	070202 L-GF	0.3-1.5	0.03-0.17									●					
	070202 R-GF	0.3-1.5	0.03-0.17									●					
	11T3003 L-GF	0.2-2.5	0.02-0.15									●					
	11T3003 R-GF	0.2-2.5	0.02-0.15									●					
	11T301 L-GF	0.2-2.5	0.02-0.15									●					
	11T301 R-GF	0.2-2.5	0.02-0.15									●					
	11T302 L-GF	0.3-2.5	0.03-0.17									●					
	11T302 R-GF	0.3-2.5	0.03-0.17									●					
 Right hand Finishing	DPGT 0702003 L-FF	0.05-0.3	0.03-0.10									●					
	0702003 R-FF	0.05-0.3	0.03-0.10									●					
	070201 L-FF	0.08-0.4	0.03-0.12									●					
	070201 R-FF	0.08-0.4	0.03-0.12									●					
	070202 L-FF	0.1-0.4	0.03-0.15									●					
	070202 R-FF	0.1-0.4	0.03-0.15									●					
	11T3003 L-FF	0.05-0.4	0.03-0.10									●					
	11T3003 R-FF	0.05-0.4	0.03-0.10									●					
	11T301 L-FF	0.1-0.5	0.03-0.12									●					
	11T301 R-FF	0.1-0.5	0.03-0.12									●					
	11T302 L-FF	0.1-0.5	0.03-0.15									●					
	11T302 R-FF	0.1-0.5	0.03-0.15									●					

● : Standard items

Positive 7° clearance high feed inserts

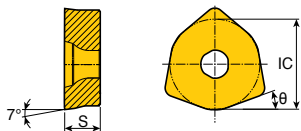

Size	Dimension (mm)		
	IC	S	θ
10-HFG	15.45	6.5	15°
10-HFP	16.45	6.5	20°

Insert	Designation	ap (mm)	Feed (mm/rev)	Coating																					
				Cermat			CVD coated							PVD coated											
				PV3010	CT3000	TT3005	TT7005	TT7015	TT7025	TT8105B	TT8115B	TT8125B	TT8135B	TT9215	TT9225	TT9235	TT5100	TT7100	TT5080	TT8020	TT9080	TT3010	TT3020	TT9020	K10
 High feed For general	FCMX 100616-HFG	0.5-2.0	1.50-3.00																						
 High feed For alloy steel	FCMX 100616-HFP	0.5-2.5	1.00-2.50																						

● : Standard items



RCGT RCMT RCMX



Positive 7° clearance round inserts

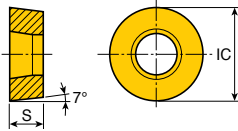

Size	Dimension (mm)		Size	Dimension (mm)	
	IC	S		IC	S
08	8.0	3.18	20	20.0	6.35
10	10.0	3.18-3.97	25	25.0	7.94
12	12.0	4.76	32	32.0	9.52
16	16.0	6.35			

Insert	Designation	ap (mm)	Feed (mm/rev)	Coating																						
				Cermat		CVD coated										PVD coated										
				PV3010	CT3000	TT3005	TT7015	TT7025	TT8105B	TT8115B	TT8125B	TT8135B	TT9215	TT9225	TT9235	TT15100	TT17100	TT15080	TT18020	TT19080	TT13010	TT13020	TT19020	K10		
Medium For aluminum	RCGT 0803MO FL	1.0-4.0	0.20-0.40																						●	
	1003MO FL	1.0-5.0	0.20-0.40																							●
	10T3MO FL	1.0-5.0	0.20-0.40																							●
Medium	RCMT 080300 MGS	0.5-2.0	0.15-0.30			●																●	●		●	
	120400 MGS	1.0-3.0	0.25-0.50			●																●	●		●	
Medium	RCMT 080300 MT	0.5-3.0	0.15-0.40							●	●						●									
	10T300 MT	1.0-4.0	0.20-0.50				●	●		●	●						●									
	120400 MT	2.0-5.0	0.30-0.60				●	●		●	●															
	160600 MT	3.0-7.0	0.40-0.80								●															
Medium	RCMT 120400 PC	2.0-5.0	0.30-0.60						●	●	●		●	●	●			●								
Roughing	RCMX 100300	1.5-4.0	0.25-0.50				●	●		●	●						●								●	
	120400	2.5-5.0	0.30-0.60				●	●		●	●						●	●							●	
	160600	3.0-7.0	0.40-0.75				●	●		●	●						●								●	
	200600	3.5-9.0	0.48-0.90				●	●		●	●	●					●								●	
	250700	4.0-12.0	0.55-1.20				●	●	●	●	●	●					●		●						●	
	320900	5.0-15.0	0.65-1.50				●			●	●	●					●								●	
Roughing	RCMX 100300 RA	1.0-4.0	0.20-0.50							●	●	●														
	120400 RA	2.0-5.0	0.25-0.60							●	●	●		●												
	160600 RA	2.5-7.0	0.35-0.75							●	●	●														
	200600 RA	3.0-9.0	0.40-0.90				●			●	●	●									●					
	250700 RA	3.5-12.0	0.50-1.20							●	●	●	●					●								
	320900 RA	4.0-15.0	0.60-1.50							●	●	●						●								

● : Standard items



A74, A75,
A95, A96,
A184

Positive 7° clearance square inserts

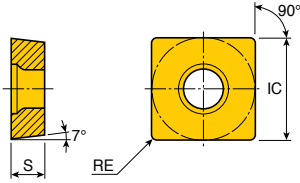

Size	Dimension (mm)		
	IC	S	RE
09	9.52	3.97	0.4-0.8
12	12.7	4.76	0.2-1.2

Insert	Designation	ap (mm)	Feed (mm/rev)	Coating																						
				Cermet			CVD coated							PVD coated				K10								
				PV3010	CT3000	TT3005	TT7005	TT7015	TT7025	TT8105B	TT8115B	TT8125B	TT8135B	TT9215	TT9225	TT9235	TT5100		TT7100	TT5080	TT8020	TT9080	TT3010	TT3020	TT9020	
 Medium For aluminum	SCGT 09T308 FL	0.5-3.0	0.10-0.30																						●	
	120402 FL	0.5-3.0	0.10-0.30																							●
	120404 FL	0.5-4.0	0.10-0.30																							●
	120408 FL	1.0-4.0	0.10-0.30																							●
 Finishing	SCMT 09T304 FG	0.6-2.0	0.08-0.25								●			●							●	●				
	09T308 FG	0.6-2.0	0.10-0.25								●	●		●		●				●	●					
 Medium	SCMT 09T304 FM	0.5-2.5	0.08-0.25								●	●					●			●	●					
	09T308 FM	0.8-2.5	0.10-0.25								●	●					●			●	●					
 Medium	SCMT 09T304 MT	0.7-3.5	0.10-0.25	●	●		●	●		●	●	●		●		●				●						
	09T308 MT	1.0-3.5	0.13-0.30	●		●	●	●		●	●	●		●	●	●	●			●	●					
	120404 MT	1.0-5.0	0.10-0.25	●		●	●			●	●						●									
	120408 MT	1.0-5.0	0.13-0.30	●		●	●	●		●	●	●		●	●	●				●	●					
	120412 MT	1.0-5.0	0.15-0.35			●	●			●	●	●									●					
 Medium	SCMT 09T304 PC	0.35-3.0	0.08-0.25								●	●		●	●						●					
	09T308 PC	0.5-3.0	0.10-0.28								●	●		●	●						●					
	120404 PC	0.4-4.0	0.08-0.25								●	●		●	●						●					
	120408 PC	0.7-4.0	0.10-0.30								●	●		●	●						●					
	120412 PC	1.0-4.0	0.12-0.35								●	●		●	●						●					



●: Standard items

SPGN SPMR SPUN



Positive 11° clearance square inserts

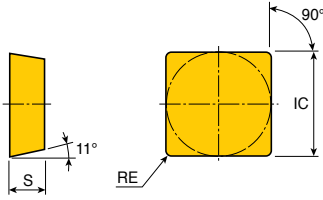

Size	Dimension (mm)		
	IC	S	RE
09	9.52	3.18	0.4-0.8
12	12.7	3.18-4.76	0.4-1.6
15	15.88	4.76	0.4-1.2
19	19.05	4.76	0.4-1.2

Insert	Designation	ap (mm)	Feed (mm/rev)	Coating																					
				Cermet		CVD coated								PVD coated				K10							
				PV3010	CT3000	TT3005	TT7015	TT7025	TT8105B	TT8115B	TT8125B	TT8135B	TT9215	TT9225	TT9235	TT15100	TT17100		TT15080	TT18020	TT19080	TT13010	TT13020	TT19020	
 Finishing	SPGN 090304	0.7-3.5	0.08-0.20							●														●	
	090308	0.7-3.5	0.10-0.25							●															●
	120304	1.0-5.0	0.08-0.20			●																			●
	120308	1.0-5.0	0.10-0.25							●	●														●
	120312	1.0-5.0	0.15-0.30																	●					
	120404	1.0-5.0	0.08-0.20																						
	120408	1.0-5.0	0.10-0.25																						●
	120412	1.0-5.0	0.15-0.30																						
	120416	1.0-5.0	0.18-0.33																						●
	150404	1.5-7.0	0.08-0.20								●														●
	150408	1.5-7.0	0.10-0.25																						
	150412	1.5-7.0	0.15-0.30																						
190404	1.5-9.0	0.08-0.20								●															
190408	1.5-9.0	0.10-0.25																						●	
 Medium	SPMR 090304	0.7-3.5	0.10-0.25							●	●					●									
	090308	1.0-3.5	0.13-0.30							●	●					●									
	120304	1.0-5.0	0.10-0.25							●	●					●									
	120308	1.0-5.0	0.13-0.30							●	●	●				●									
	120312	1.0-5.0	0.15-0.35										●												
 Medium	SPUN 090304	1.0-3.5	0.10-0.30																						
	090308	1.0-3.5	0.15-0.40																						
	120304	1.0-5.0	0.10-0.30							●	●														
	120308	1.0-5.0	0.15-0.40							●	●													●	
	120312	1.0-5.0	0.20-0.50																						
	150404	1.5-7.0	0.10-0.30														●								
190412	1.5-9.0	0.20-0.50								●															



● : Standard items

Positive 7° clearance triangular inserts

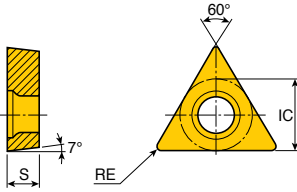

Size	Dimension (mm)		
	IC	S	RE
08	4.76	2.38	0.03-0.2
09	5.56	2.36	0.4
11	6.35	2.38-3.18	0.03-0.4
16	9.52	3.97	0.4-0.8

Insert	Designation	ap (mm)	Feed (mm/rev)	Cermet		PVD coated								Uncoated			
				PV3010	CT3000	TT5080	TT8020	TT9080	TT3010	TT3020	TT9020	TT4410	TT4430	P20	K10		
 Right hand Finishing	TCET 0802003 L-GF	0.2-1.5	0.02-0.12														
	0802003 R-GF	0.2-1.5	0.02-0.12									●					
	080201 L-GF	0.2-1.5	0.02-0.15									●					
	080201 R-GF	0.2-1.5	0.02-0.15									●					
	080202 L-GF	0.3-1.5	0.03-0.17									●					
	080202 R-GF	0.3-1.5	0.03-0.17									●					
	1103003 L-GF	0.2-1.5	0.02-0.12									●					
	1103003 R-GF	0.2-1.5	0.02-0.12									●					
	110301 L-GF	0.2-1.5	0.02-0.15									●					
	110301 R-GF	0.2-1.5	0.02-0.15									●					
	110302 L-GF	0.3-1.5	0.03-0.17									●					
	110302 R-GF	0.3-1.5	0.03-0.17									●					
	110304 L-GF	0.5-1.5	0.05-0.20									●					
110304 R-GF	0.5-1.5	0.05-0.20									●						
 Medium For aluminum	TCGT 090204 FL	0.2-2.5	0.05-0.25														●
	110204 FL	0.2-3.0	0.05-0.30														●
	16T304 FL	0.5-3.0	0.05-0.30														●
	16T308 FL	0.5-3.0	0.10-0.30														●
 Finishing	TCGT 110201 SA	0.1-2.5	0.01-0.05														●
	110202 SA	0.2-2.5	0.02-0.15														●
	110204 SA	0.2-2.5	0.03-0.20														●

A98-A100,
 A221, A259

● : Standard items

Positive 7° clearance triangular inserts

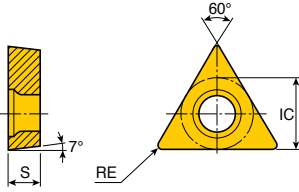

Size	Dimension (mm)		
	IC	S	RE
06	3.97	1.98	0.2
09	5.56	2.38	0.2-0.8
11	6.35	2.38	0.2-0.8
16	9.52	3.97	0.4-1.2
22	12.7	4.76	0.8

Insert	Designation	ap (mm)	Feed (mm/rev)	Coating																						
				Cermert		CVD coated							PVD coated													
				PV3010	CT3000	TT3005	TT7005	TT7015	TT7025	TT8105B	TT8115B	TT8125B	TT8135B	TT9215	TT9225	TT9235	TT5100	TT7100	TT5080	TT8020	TT9080	TT3010	TT3020	TT9020	K10	
Finishing	TCMT 06T102 FA	0.4-1.2	0.03-0.15	•													•									
	110202 FA	0.1-1.5	0.03-0.15	•							•								•		•					
	110204 FA	0.1-1.5	0.05-0.15	••							•							•								
Finishing	TCMT 090208 FG	0.6-1.5	0.10-0.25	••						••							•									
	110204 FG	0.4-1.5	0.07-0.20	••						•					••	••				••	••					
	110208 FG	0.6-1.5	0.10-0.25	••		••				••	••				••	••				•						
	16T304 FG	0.4-2.0	0.07-0.20	••		•				•											•					
	16T308 FG	0.6-2.0	0.10-0.25	••		••				••	••										•		•			
Medium	TCMT 090202 FM	0.5-1.5	0.07-0.20							••							•			••	••					
	090204 FM	0.5-1.5	0.08-0.20							••							•			••	••					
	110202 FM	0.5-1.5	0.07-0.20							••	••						•			••	••					
	110204 FM	0.5-1.5	0.08-0.20							••	••						•			••	••					
	110208 FM	0.8-1.5	0.10-0.20							••	••						•			••	••					
	16T304 FM	0.5-2.0	0.08-0.20							••	••						•			••	••					
	16T308 FM	0.8-2.0	0.10-0.20							••	••						•			••	••					
	16T312 FM	1.0-2.5	0.10-0.25							••	••						•			••	••					
Medium Type B	TCMT 090204 MT	✓ 0.6-2.0	0.10-0.25	••		••				••					••	••				••	••					
	090208 MT	✓ 0.8-2.0	0.13-0.30	•		••				••					•	•				••	••					
	110204 MT	✓ 0.6-3.0	0.10-0.25	••		••				••	••				••	••				••	••				•	
	110208 MT	✓ 0.8-3.0	0.13-0.30	••		••				••	••				••	••				••	••					
	16T304 MT	0.8-5.0	0.10-0.25	•		••				••	••	••			••	••				•						
	16T308 MT	1.0-5.0	0.10-0.30	••		••			•	••	••	••			••	••				••	••					•
	16T312 MT	1.5-5.0	0.10-0.30			•				•																
	220408 MT	2.0-6.0	0.10-0.35								•															
Medium	TCMT 090204 PC	0.3-2.0	0.06-0.18							••		••			••						•					
	090208 PC	0.4-2.0	0.08-0.25							••		••			••						•					
	110204 PC	0.3-2.5	0.06-0.20							••		••			••						•					
	110208 PC	0.42-2.5	0.09-0.26							••		••			••						•					
	16T304 PC	0.35-3.0	0.08-0.25							••		••			••						•					
	16T308 PC	0.5-3.0	0.10-0.28							••		••			••						•					
16T312 PC	0.6-3.0	0.12-0.36							••		••			••						•						

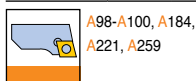

• ✓ Marked: Type B chip breaker

••: Standard items

Positive 11° clearance triangular inserts

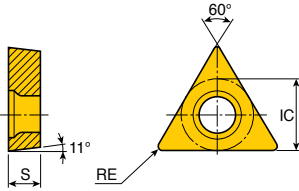

Size	Dimension (mm)		
	IC	S	RE
08	4.76	2.38	0.03-0.2
11	6.35	3.18	0.03-0.2

Insert	Designation	ap (mm)	Feed (mm/rev)	Cermet		PVD coated							Uncoated	
				PV3010	CT3000	TT5080	TT8020	TT9080	TT3010	TT3020	TT9020	TT4410	TT4430	P20
<p>Right hand Finishing</p>	TPET 0802003 L-GF	0.2-1.5	0.02-0.12									●		
	0802003 R-GF	0.2-1.5	0.02-0.12									●		
	080201 L-GF	0.2-1.5	0.02-0.15									●		
	080201 R-GF	0.2-1.5	0.02-0.15									●		
	080202 L-GF	0.3-1.5	0.03-0.17									●		
	080202 R-GF	0.3-1.5	0.03-0.17									●		
	1103003 L-GF	0.2-1.5	0.02-0.12									●		
	1103003 R-GF	0.2-1.5	0.02-0.12									●		
	110301 L-GF	0.2-1.5	0.02-0.15									●		
	110301 R-GF	0.2-1.5	0.02-0.15									●		
	110302 L-GF	0.3-1.5	0.03-0.17									●		
	110302 R-GF	0.3-1.5	0.03-0.17									●		
<p>Right hand Finishing</p>	TPGT 0802003 L-FF	0.05-0.3	0.03-0.10									●		
	0802003 R-FF	0.05-0.3	0.03-0.10									●		
	080201 L-FF	0.08-0.4	0.03-0.12									●		
	080201 R-FF	0.08-0.4	0.03-0.12									●		
	080202 L-FF	0.1-0.4	0.03-0.15									●		
	080202 R-FF	0.1-0.4	0.03-0.15									●		
	1103003 L-FF	0.05-0.4	0.03-0.10									●		
	1103003 R-FF	0.05-0.4	0.03-0.10									●		
	110301 L-FF	0.1-0.5	0.03-0.12									●		
	110301 R-FF	0.1-0.5	0.03-0.12									●		
	110302 L-FF	0.1-0.5	0.03-0.15									●		
	110302 R-FF	0.1-0.5	0.03-0.15									●		



● : Standard items

TPGN TPGT TPGX



Positive 11° clearance triangular inserts

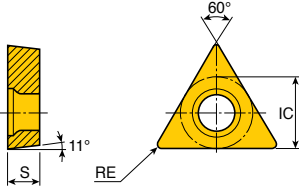

Size	Dimension (mm)		
	IC	S	RE
09	5.56	2.38	0.2-0.4
11	6.35	3.18	0.2-0.8
16	9.52	4.76	0.2-1.2
22	12.7	4.76	0.4-3.0
27	15.88	6.35	0.8

Insert	Designation	ap (mm)	Feed (mm/rev)	Coating																										
				Cermat			CVD coated							PVD coated			P20	K10												
				PV3010	CT3000	TT3005	TT7005	TT7015	TT7025	TT8105B	TT8115B	TT8125B	TT8135B	TT9215	TT9225	TT9235			TT5100	TT7100	TT5080	TT8020	TT9080	TT3010	TT3020	TT9020				
 Finishing	TPGN 090204	0.5-3.0	0.07-0.20																							●	●			
	110304	0.7-3.0	0.07-0.20																								●	●		
	110308	1.0-3.0	0.10-0.25										●															●		
	160302	1.0-5.0	0.05-0.18																									●		
	160304	1.0-5.0	0.07-0.20										●															●	●	
	160308	1.0-5.0	0.10-0.25					●				●	●															●	●	
	160312	1.0-5.0	0.15-0.30																									●		
	220404	1.5-7.0	0.07-0.20																									●	●	
	220408	1.5-7.0	0.10-0.25																										●	
	220412	1.5-7.0	0.15-0.30																										●	●
	220416	1.5-7.0	0.20-0.35																									●		
	220425	1.5-7.0	0.25-0.40																										●	
	220430	1.5-7.0	0.30-0.45																											
270608	3.0-8.0	0.15-0.25										●																		
 Right hand Finishing	TPGT 090204 L-C	0.3-1.5	0.05-0.20			●																								
	110304 L-C	0.5-2.0	0.05-0.20			●																							●	
	110304 R-C	0.5-2.0	0.05-0.20			●																								
	110308 L-C	0.5-2.0	0.07-0.25			●																								
	160404 L-C	0.7-3.0	0.05-0.20			●																								
	160404 R-C	0.7-3.0	0.05-0.20			●																								
 Left hand Finishing	TPGX 090202 L	0.4-1.5	0.05-0.15			●																						●		
	090204 L	0.6-1.5	0.08-0.20			●																						●		
	110302 L	0.5-1.5	0.08-0.20			●																								
	110302 R	0.5-1.5	0.08-0.20			●																								
	110304 L	0.6-2.0	0.08-0.20			●																						●		
	110304 R	0.6-2.0	0.08-0.20			●																								



● : Standard items

Positive 11° clearance triangular inserts

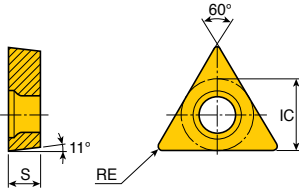

Size	Dimension (mm)		
	IC	S	RE
09	5.56	2.38	0.2-0.8
11	6.35	2.38-3.18	0.2-0.8
16	9.52	3.18-3.97	0.2-1.2
22	12.7	4.76	0.4-1.2

Insert	Designation	ap (mm)	Feed (mm/rev)	Cermat		CVD coated								PVD coated				K10						
				PV3010	CT3000	TT3005	TT7005	TT7015	TT7025	TT8105B	TT8115B	TT8125B	TT8135B	TT9215	TT9225	TT9235	TT5100		TT7100	TT5080	TT8020	TT9080	TT3010	TT3020
 Type B Medium	TPMR 090204 ✓	0.5-2.0	0.10-0.25																					
	090208 ✓	0.7-2.0	0.13-0.30																					
	110304 ✓	0.7-3.0	0.10-0.25																					
	110308	1.0-3.0	0.13-0.30																					
	160304 ✓	1.0-5.0	0.10-0.25																					
	160308	1.0-5.0	0.13-0.30																					
	160312	1.0-5.0	0.15-0.35																					
	220404 ✓	1.0-7.0	0.10-0.25																					
	220408 ✓	1.5-7.0	0.13-0.30																					
220412 ✓	1.5-7.0	0.15-0.35																						
 Finishing	TPMT 090202 FA	0.1-1.2	0.03-0.15																					
	090204 FA	0.2-1.2	0.05-0.20																					
	110302 FA	0.1-1.5	0.03-0.15																					
	110304 FA	0.2-1.5	0.05-0.20																					
	110308 FA	0.3-1.5	0.08-0.25																					
	16T304 FA	0.2-2.0	0.05-0.20																					
	16T308 FA	0.3-2.0	0.08-0.25																					
 Finishing	TPMT 110304 FG	0.4-1.5	0.07-0.20																					
 Medium	TPMT 090202 FM	0.5-1.5	0.07-0.20																					
	090204 FM	0.5-1.5	0.08-0.20																					
	110302 FM	0.5-1.5	0.07-0.20																					
	110304 FM	0.5-1.5	0.08-0.20																					
	110308 FM	0.8-1.5	0.10-0.20																					
	160302 FM	0.5-2.0	0.07-0.20																					
	160304 FM	0.5-2.0	0.08-0.20																					
	160308 FM	0.8-2.5	0.10-0.25																					
 Medium	TPMT 090204 PC	0.3-2.0	0.06-0.18																					
	110204 PC	0.4-2.5	0.06-0.20																					
	110208 PC	0.5-2.5	0.10-0.26																					
	110304 PC	0.4-2.5	0.06-0.20																					
	110308 PC	0.5-2.5	0.10-0.26																					
	16T304 PC	0.45-3.0	0.08-0.25																					
16T308 PC	0.5-3.0	0.10-0.30																						



✓ : Marked: Type B chip breaker ● : Standard items

VBET VBGT



Positive 5° clearance 35° rhombic inserts

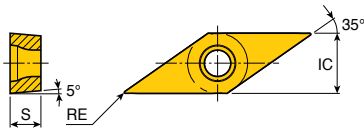

Size	Dimension (mm)		
	IC	S	RE
11	6.35	3.18	0.03-0.4
16	9.52	4.76	0.1-0.4

Insert	Designation	ap (mm)	Feed (mm/rev)	Cermet		PVD coated								Uncoated		
				PV3010	CT3000	TT5080	TT18020	TT9080	TT3010	TT3020	TT9020	TT4410	TT4430	P20	K10	
 Right hand Finishing	VBET 110301 L-GF	0.2-1.5	0.02-0.15									●				
	110301 R-GF	0.2-1.5	0.02-0.15									●				
	110302 L-GF	0.3-1.5	0.03-0.17									●				
	110302 R-GF	0.3-1.5	0.03-0.17									●				
	110304 L-GF	0.3-1.5	0.05-0.20									●				
	110304 R-GF	0.3-1.5	0.05-0.20									●				
 Right hand Finishing	VBET 1103003 L-GW*	0.1-1.5	0.02-0.15									●				
	1103003 R-GW*	0.1-1.5	0.02-0.15									●				
 Left hand Finishing	VBGT 1103003 L-FF	0.05-0.4	0.03-0.10									●				
	1103003 R-FF	0.05-0.4	0.03-0.10									●				
	110301 L-FF	0.1-0.5	0.03-0.12									●				
	110301 R-FF	0.1-0.5	0.03-0.12									●				
	110302 L-FF	0.1-0.5	0.03-0.15									●				
	110302 R-FF	0.1-0.5	0.03-0.15									●				
 Finishing	VBGT 110301 SA	0.1-1.5	0.01-0.20			●						●				
	110302 SA	0.2-1.5	0.02-0.20			●						●				
	110304 SA	0.2-1.5	0.05-0.20			●						●				
	160401 SA	0.1-1.5	0.01-0.20			●						●				
	160402 SA	0.2-1.5	0.02-0.20			●						●				
	160404 SA	0.2-2.5	0.03-0.20									●				
 Finishing For Swiss	VBGT 110302M SL-F	0.02-0.25	0.02-0.10										●	●		
 Medium For Swiss	VBGT 110301M SM-F	0.2-1.5	0.02-0.12										●	●		
	110302M SM-F	0.2-1.5	0.02-0.12										●	●		
	110304M SM-F	0.2-1.5	0.03-0.12										●	●		

A102, A103, A108-A110, A116,
 A118, A119, A168, A169, A185,
 A228, A230, A260

● * Marked: Wiper inserts should be applied to
 □ VJBR/L...

● : Standard items

VBGT VBMT



Positive 5° clearance 35° rhombic inserts

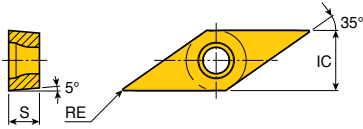

Size	Dimension (mm)		
	IC	S	RE
11	6.35	3.18	0.4-0.8
16	9.52	4.76	0.4-1.2

Insert	Designation	ap (mm)	Feed (mm/rev)	Coating																					
				Cermet		CVD coated								PVD coated											
				PV3010	CT3000	TT3005	TT7005	TT7015	TT7025	TT8105B	TT8115B	TT8125B	TT8135B	TT9215	TT9225	TT9235	TT5100	TT7100	TT5080	TT8020	TT9080	TT3010	TT3020	TT9020	K10
Finishing	VBGT 160404 FGS	0.2-2.5	0.03-0.20			●														●		●	●	●	
	160408 FGS	0.3-2.5	0.05-0.20			●														●		●	●	●	
	160412 FGS	0.3-2.5	0.07-0.20			●														●		●	●	●	
Finishing	VBMT 110304 FA	0.2-1.5	0.05-0.20	●	●						●	●						●		●	●				
	160404 FA	0.2-2.0	0.05-0.20	●	●						●	●						●		●	●				
	160408 FA	0.3-2.0	0.08-0.25	●	●						●	●						●		●	●				
Finishing	VBMT 160404 FG	0.5-1.5	0.07-0.20	●	●	●	●				●	●	●	●	●	●	●	●		●	●	●	●	●	
	160408 FG	0.7-2.0	0.10-0.25	●	●	●	●	●			●	●	●	●	●	●	●	●		●	●	●	●	●	
Medium	VBMT 110304 FM	0.5-1.5	0.08-0.20								●	●						●		●	●				
	110308 FM	0.5-1.5	0.10-0.20								●	●						●		●	●				
	160404 FM	0.5-2.0	0.08-0.20								●	●						●		●	●				
	160408 FM	0.8-2.0	0.10-0.20								●	●						●		●	●				
	160412 FM	1.0-2.5	0.10-0.25								●	●						●		●	●				
Finishing	VBMT 160404 FX	0.2-2.0	0.05-0.20	●	●						●	●							●		●				
	160408 FX	0.2-2.0	0.07-0.20	●	●						●	●	●							●		●			
Medium	VBMT 160404 MT	0.6-3.0	0.10-0.25	●	●	●	●	●	●	●	●	●	●	●	●	●	●	●	●	●	●	●	●	●	●
	160408 MT	0.9-3.0	0.13-0.30	●	●	●	●	●	●	●	●	●	●	●	●	●	●	●	●	●	●	●	●	●	●
	160412 MT	1.2-3.0	0.15-0.30								●	●						●							
Medium	VBMT 160404 PC	0.5-2.8	0.07-0.22								●	●		●							●				
	160408 PC	0.5-2.8	0.10-0.27								●	●		●							●				
	160412 PC	0.5-2.8	0.10-0.28			●					●	●					●		●						



A102, A103, A108-A110, A116,
A118, A119, A168, A169, A185,
A228, A230, A232, A233, A260

●: Standard items

Positive 7° clearance 35° rhombic inserts

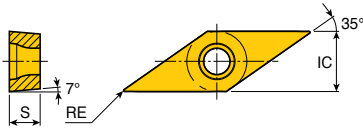

Size	Dimension (mm)		
	IC	S	RE
11	6.35	3.18	0.1-0.4
16	9.52	4.76	0.2-1.2
22	12.7	5.56	3.0

Insert	Designation	ap (mm)	Feed (mm/rev)	Cermet		PVD coated								Uncoated		
				PV3010	CT3000	TT5080	TT8020	TT9080	TT3010	TT3020	TT9020	TT4410	TT4430	P20	K10	
 Medium For aluminum	VCGT 110302 FL	0.2-2.5	0.05-0.20													●
	110304 FL	0.5-3.0	0.05-0.25													●
	160402 FL	0.5-2.5	0.05-0.25													●
	160404 FL	0.5-3.0	0.05-0.25													●
	160408 FL	0.5-3.0	0.10-0.25													●
	160412 FL	0.5-3.0	0.10-0.25													●
	220530 FL	1.5-4.5	0.15-0.30													●
 TOP MINI Finishing	VCGT 110301 SA	0.1-1.5	0.01-0.20			●				●						
	110302 SA	0.2-1.5	0.02-0.20			●				●						
	110304 SA	0.2-1.5	0.05-0.20			●				●						
 TOP MINI Medium For Swiss	VCGT 110301M SM-F	0.2-1.5	0.02-0.12									●	●			
	110302M SM-F	0.2-1.5	0.02-0.12									●	●			
	110304M SM-F	0.2-1.5	0.03-0.12									●	●			
 TOP MINI Finishing For Swiss	VCGT 110302M SL-F	0.02-0.25	0.02-0.10											●	●	

A104, A105,
 A230, A232, A233

● : Standard items





VPET VPGT

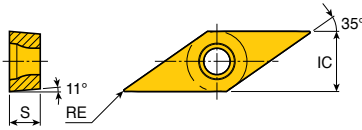

Positive 11° clearance 35° rhombic inserts



Size	Dimension (mm)		
	IC	S	RE
08	4.76	2.38	0.1-0.2
11	6.35	3.18	0.03-0.2

Insert	Designation	ap (mm)	Feed (mm/rev)	Cermet		PVD coated								Uncoated				
				PV3010	CT3000	TT5080	TT18020	TT9080	TT3010	TT3020	TT9020	TT4410	TT4430	P20	K10			
  Right hand Finishing	VPET 080201 L-GF	0.2-1.5	0.02-0.15															
	080201 R-GF	0.2-1.5	0.02-0.15															
	080202 L-GF	0.3-1.5	0.03-0.17															
	080202 R-GF	0.3-1.5	0.03-0.17															
	1103003 L-GF	0.2-1.5	0.02-0.12															
	1103003 R-GF	0.2-1.5	0.02-0.12															
	110301 L-GF	0.2-1.5	0.02-0.15															
	110301 R-GF	0.2-1.5	0.02-0.15															
	110302 L-GF	0.3-1.5	0.03-0.17															
	110302 R-GF	0.3-1.5	0.03-0.17															
  Left hand Finishing	VPGT 080201 L-FF	0.08-0.4	0.03-0.12															
	080201 R-FF	0.08-0.4	0.03-0.12															
	080202 L-FF	0.1-0.4	0.03-0.15															
	080202 R-FF	0.1-0.4	0.03-0.15															
	1103003 L-FF	0.05-0.4	0.03-0.10															
	1103003 R-FF	0.05-0.4	0.03-0.10															
	110301 L-FF	0.1-0.5	0.03-0.12															
	110301 R-FF	0.1-0.5	0.03-0.12															
	110302 L-FF	0.1-0.5	0.03-0.15															
	110302 R-FF	0.1-0.5	0.03-0.15															

● : Standard items



Inserts

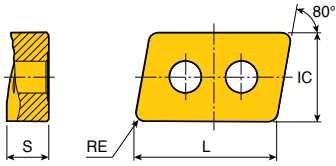

Size	Dimension (mm)			
	L	IC	S	RE
40	40.6	25.4	11.65	2.38

Insert	Designation	ap (mm)	Feed (mm/rev)	Coating																					
				Cermet		CVD coated							PVD coated		K10										
				PV3010	CT3000	TT3005	TT7005	TT7015	TT7025	TT8105B	TT8115B	TT8125B	TT8135B	TT9215		TT9225	TT9235	TT5100	TT7100	TT5080	TT8020	TT9080	TT3010	TT3020	TT9020
	LNMM 401224 R-HX	6.0-32.0	0.70-1.50									●	●	●				●							
	LNMM 401224 L-HX	6.0-32.0	0.70-1.50									●						●							
Roughing																									

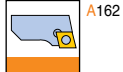



● : Standard items

LNMX

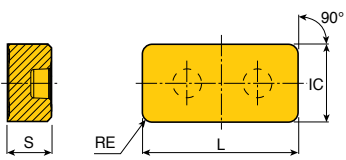
Inserts



Size	Dimension (mm)			
	L	IC	S	RE
50	50.8	25.4	14.2	3.2

Insert	Designation	ap (mm)	Feed (mm/rev)	Coating																					
				Cermet		CVD coated							PVD coated		K10										
				PV3010	CT3000	TT3005	TT7005	TT7015	TT7025	TT8105B	TT8115B	TT8125B	TT8135B	TT9215		TT9225	TT9235	TT5100	TT7100	TT5080	TT8020	TT9080	TT3010	TT3020	TT9020
	LNMX 501432 HD	6.0-40.0	0.70-1.60									●	●					●							
Roughing																									
	LNMX 501432 HY	5.0-40.0	0.65-1.50									●		●				●							
Roughing																									



● : Standard items

TOP-RAIL inserts

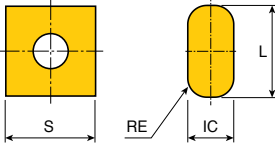

Size	Dimension (mm)			
	L	IC	S	RE
19	19.05	10	19.05	4.0
30	30	12	19.05	4.0

Insert	Designation	ap (mm)	Feed (mm/rev)	Coating																							
				Cermet		CVD coated										PVD coated											
				PV3010	CT3000	TT3005	TT7005	TT7015	TT7025	TT8105B	TT8115B	TT8125B	TT8135B	TT9215	TT9225	TT9235	TT5100	TT7100	TT5080	TT8020	TT9080	TT3010	TT3020	TT9020	K10		
 Finishing	LNMX 191940 TWF	0.3-5.0	0.30-1.0										●	●	●												
 Medium	LNMX 191940 TWM	1.5-9.0	0.45-1.5										●	●	●												
	301940 TWM	1.5-15.0	0.50-1.5										●	●	●												
 Roughing	LNMX 301940 TWR	2.0-15.0	0.70-1.8										●	●	●												



● : Standard items

Hard Turning for Ceramic Inserts

Selection guide for ceramic grades

For cast iron

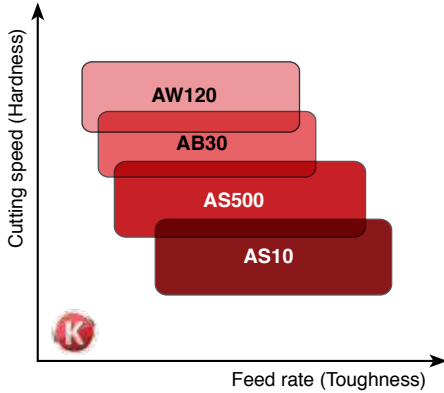

For hardened steel (HRc 40~60)

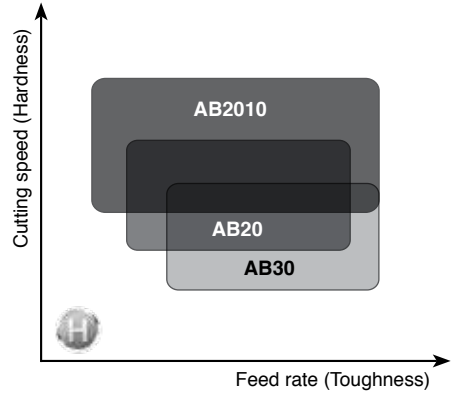

For super alloys

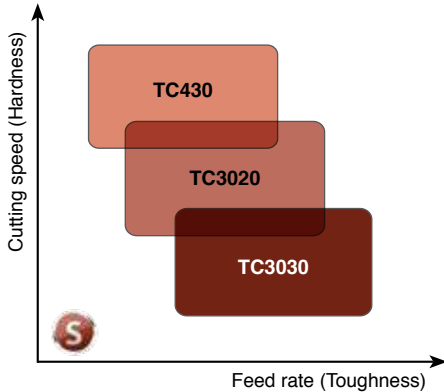

Edge preparations for ceramic inserts

Single land		Double land			
Symbol	Width(mm) X angle	Symbol	Width(mm) X angle		Shape
			L1 X A1	L2 X A2	
T2	0.10 X 30°	U1	0.7 X 15°	0.15 X 30°	
T3	0.15 X 30°	U2	1.5 X 15°	0.15~0.2 X 30°	
T4	0.20 X 30°	U3	2.0 X 15°	0.2 X 30°	
T5	0.30 X 20°	- All items are honed			
T6	0.10 X 20°				
T7	0.20 X 20°				

• Edge preparations of non symbol items is 0.2 X 25° with no hone except □NMG-CE 0.25 X 20° with hone

Hard Turning for CBN and PCD Inserts

Selection guide for CBN and PCD grades

For hardened steel (HRc ≥ 50, CBN)

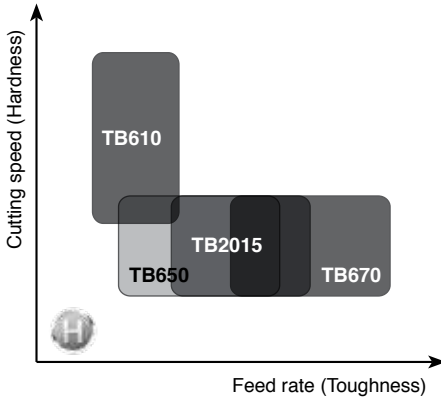

For cast iron (CBN)

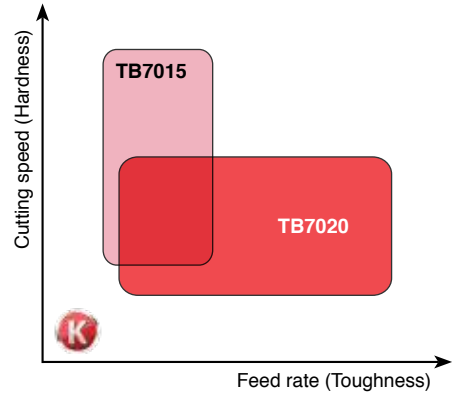

- TB730 for General turning of sintered or powder metals

For non-ferrous material (PCD)

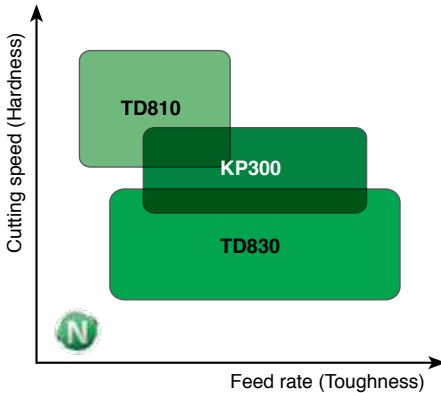

Information of CBN type

LS	Brazed small size CBN Tip, 1 corner
LS2	Brazed small size CBN Tip, 2 corners
LN	Brazed large size CBN Tip, 1 corner
LN2	Brazed large size CBN Tip, 2 corners
SD	Solid type
FT	Full Top type
DA	Dimple type
WZ	Wiper geometry

Edge preparations for CBN inserts

Single land				
Symbol	Width(mm) X angle L X A	Symbol	Width(mm) X angle L X A	Shape
TL	0.13X15°	SL	0.13X15°+ honed	
TM	0.13X25°	SM	0.13X25°+ honed	
TH	0.13X35°	SH	0.13X35°+ honed	

- Edge preparations of non symbol items depends on grades

TB610, TB2015, TB650, TB670: 0.13x20°+honed

TB730, TB7015 : 0.13x20°+no honed

TB7020 : 0.20x20°+honed

Negative 80° rhombic inserts

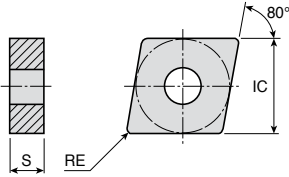

Size	Dimension (mm)		
	IC	S	RE
12	12.7	4.76	0.4-1.6
16	15.88	4.76-6.35	0.8-1.6
19	19.05	6.35-7.94	0.8-1.2

Insert	Designation	ap (mm)	Feed (mm/rev)	Ceramic												
				AB2010	AB20	AB30	AW120	AS500	SC10	AS10	TC430	TC3020	TC3030			
	CNGA 120404	0.10-3.00	0.05-0.15	●	●	●										
	120404 T2	0.10-3.00	0.05-0.15			●										
	120404 T7-WZ	0.10-3.00	0.05-0.15	●												
	120408	0.10-3.00	0.05-0.20	●	●	●		●	●	●						
	120408 E	0.10-3.00	0.05-0.20										●	●		
	120408 S7	0.10-3.00	0.05-0.20	●												●
	120408 T2	0.10-3.00	0.05-0.20		●	●										
	120408 T6	0.10-3.00	0.05-0.20		●								●	●	●	
	120408 T6-WZ	0.10-3.00	0.05-0.20													
	120408 T7	0.10-3.00	0.05-0.20				●	●								
	120408 T7-WZ	0.10-3.00	0.05-0.20		●	●										
	120412	0.10-3.00	0.05-0.25		●	●	●			●	●					
	120412 T2	0.10-3.00	0.05-0.25			●										
	120412 T6-WZ	0.10-3.00	0.05-0.25							●	●					
	120412 T7	0.10-3.00	0.05-0.25						●							
	120412 T7-WZ	0.10-3.00	0.05-0.25		●	●										
	120416	0.10-3.00	0.05-0.30			●	●			●	●					
160608	0.10-3.50	0.05-0.20			●											
160612	0.10-3.50	0.05-0.25				●										
160616	0.10-3.50	0.05-0.30				●										
190608	0.10-4.50	0.05-0.20				●										
190612	0.10-4.50	0.05-0.25				●										
	CNGN 120404	0.10-3.00	0.05-0.15			●										
	120404 T6	0.10-3.00	0.05-0.15									●				
	120408	0.10-3.00	0.05-0.20	●	●	●				●						
	120408 E	0.10-3.00	0.05-0.20									●	●	●		
	120408 T6	0.10-3.00	0.05-0.20									●	●	●		
	120412 E	0.10-3.00	0.05-0.25									●	●	●		
	120412 T6	0.10-3.00	0.05-0.25									●				
	120412 T7	0.10-3.00	0.05-0.25				●									
	120416	0.10-3.00	0.05-0.30								●					
	120416 T6	0.10-3.00	0.05-0.30									●				

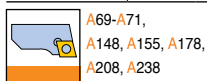

●: Standard items

CNGN CNGX-CH CNMG-CE



Negative 80° rhombic inserts

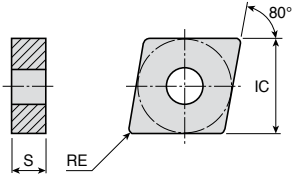

Size	Dimension (mm)		
	IC	S	RE
12	12.7	4.76-7.94	0.4-1.6

Insert	Designation	ap (mm)	Feed (mm/rev)	Ceramic													
				AB2010	AB20	AB30	AW120	SC500	AS500	SC10	AS10	TC430	TC3020	TC3030			
	CNGN 120708	0.10-3.00	0.05-0.20	●	●	●											
	120708 E	0.10-3.00	0.05-0.20										●	●	●		
	120708 T6	0.10-3.00	0.05-0.20										●	●	●		
	120712	0.10-3.00	0.05-0.25			●						●					
	120712 E	0.10-3.00	0.05-0.25										●	●	●		
	120712 T6	0.10-3.00	0.05-0.25										●	●	●		
	120712 T7	0.10-3.00	0.05-0.25				●										
	120716	0.10-3.00	0.05-0.30			●				●							
	120716 T6	0.10-3.00	0.05-0.30										●	●	●		
	120716 T7	0.10-3.00	0.05-0.30				●										
 Dimple type	CNGX 120712 CH	0.10-3.50	0.05-0.30							●	●						
	120712 T7-CH	0.10-3.50	0.05-0.30					●	●		●						
	120716 CH	0.10-3.50	0.05-0.35							●	●						
	120716 T7-CH	0.10-3.50	0.05-0.35							●							
 Pressed type	CNMG 120404 CE	0.10-3.00	0.05-0.15			●											
	120408 CE	0.10-3.00	0.05-0.20	●	●												

A69-A71, A148-A150,
A155, A178, A208,
A238, A249

● : Standard items

DNGA DNGN DNGX-CH DNMG-CE



Negative 55° rhombic inserts

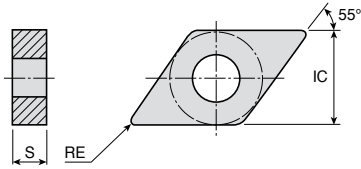

Size	Dimension (mm)		
	IC	S	RE
12	10	8.0	1.2
15	12.7	4.76-8.0	0.4-1.6

Insert	Designation	ap (mm)	Feed (mm/rev)	Ceramic											
				AB2010	AB20	AB30	AW120	AS500	SC10	AS10	TC430	TC3020	TC3030		
	DNGA 150404	0.10-2.50	0.05-0.15		●	●									
	150408	0.10-2.50	0.05-0.20	●	●	●									
	150412	0.10-2.50	0.05-0.25	●	●	●									
	150604	0.10-2.50	0.05-0.15	●	●	●									
	150608	0.10-2.50	0.05-0.20	●	●	●				●					
	150612	0.10-2.50	0.05-0.25	●	●	●				●					
	150616	0.10-2.50	0.05-0.30		●	●									
	DNGN 150408	0.10-2.50	0.05-0.20		●										
	150704	0.10-2.50	0.05-0.15			●									
	150708	0.10-2.50	0.05-0.20			●									
	150708 T6	0.10-2.50	0.05-0.20										●		
	150708 T7	0.10-2.50	0.05-0.20					●							
	150712 T6	0.10-2.50	0.05-0.25											●	
	150712 T7	0.10-2.50	0.05-0.25					●							
 Dimple type	DNGX 120712 T7-CH	0.10-3.00	0.05-0.30									●			
	150708 T7-CH	0.10-3.00	0.05-0.25									●			
	150712 CH	0.10-3.00	0.05-0.30							●		●			
	150712 T7-CH	0.10-3.00	0.05-0.30						●			●			
	150716 CH	0.10-3.50	0.05-0.35									●			
	150716 T7-CH	0.10-3.50	0.05-0.35									●			
 Pressed type	DNMG 150608 CE	0.10-2.50	0.05-0.20			●									

A63, A64, A72, A73,
A151, A156, A178,
A209, A240

●: Standard items



Negative 75° rhombic inserts

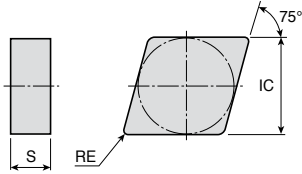

Size	Dimension (mm)		
	IC	S	RE
13	12.7	7.94	0.8-1.6

Insert	Designation	ap (mm)	Feed (mm/rev)	Ceramic										
				AB2010	AB20	AB30	AW120	AS500	SC10	AS10	TC430	TC3020	TC3030	
	ENGN 130708	0.10-2.50	0.05-0.20	●	●	●								
	130708 T5	0.10-2.50	0.05-0.20			●								
	130712 T5	0.10-2.50	0.05-0.25			●								
	130716	0.10-2.50	0.05-0.30		●									
	130716 U2	0.10-2.50	0.05-0.30			●								

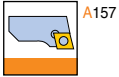

● : Standard items

HNGX-CH

Negative 120° hexagonal inserts

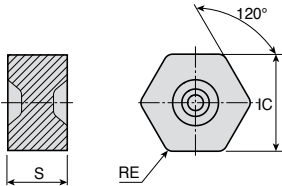

Size	Dimension (mm)		
	IC	S	RE
05	12.7	7.94	1.2-1.6

Insert	Designation	ap (mm)	Feed (mm/rev)	Ceramic										
				AB2010	AB20	AB30	AW120	AS500	SC10	AS10	TC430	TC3020	TC3030	
 Dimple type	HNGX 050712 CH	0.05-0.25	0.10-2.00							●				
	050712 T7-CH	0.05-0.25	0.10-2.00					●						
	050716 CH	0.05-0.30	0.10-2.00							●				

● : Standard items

Negative square inserts

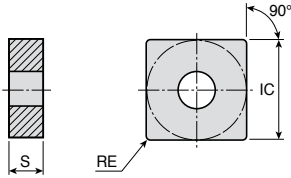

Size	Dimension (mm)		
	IC	S	RE
12	12.7	4.76-7.94	0.4-1.6
15	15.88	7.94	1.6
19	19.05	6.35-7.94	0.8-1.6

Insert	Designation	ap (mm)	Feed (mm/rev)	Ceramic											
				AB2010	AB20	AB30	AW120	AS500	SC10	AS10	TC430	TC3020	TC3030		
	SNGA 120404	0.10-3.00	0.05-0.15	●	●	●									
	120408	0.10-3.00	0.05-0.20	●	●	●									
	120408 S7	0.10-3.00	0.05-0.20	●											
	120412	0.10-3.00	0.05-0.25	●	●	●					●				
	120416	0.10-3.00	0.05-0.30							●	●				
	190608	0.10-4.50	0.05-0.20			●									
	190612	0.10-4.50	0.05-0.25			●									
	SNGN 120404	0.10-3.00	0.05-0.15	●	●	●									
	120404 T7	0.10-3.00	0.05-0.15				●								
	120408	0.10-3.00	0.05-0.20	●	●	●				●					
	120408 T6	0.10-3.00	0.05-0.20								●	●	●		
	120412	0.10-3.00	0.05-0.25	●	●	●				●					
	120412 T6	0.10-3.00	0.05-0.25											●	
	120412 T7	0.10-3.00	0.05-0.25				●								
	120416	0.10-3.00	0.05-0.30	●	●	●				●					
	120416 T6	0.10-3.00	0.05-0.30								●				
	120416 T7	0.10-3.00	0.05-0.30				●								
	120708	0.10-3.00	0.05-0.20	●	●	●									
	120708 T6	0.10-3.00	0.05-0.20								●				
	120708 T7	0.10-3.00	0.05-0.20				●								
	120712	0.10-3.00	0.05-0.25	●	●	●				●					
	120712 T6	0.10-3.00	0.05-0.25									●	●	●	
	120712 T7	0.10-3.00	0.05-0.25				●								
	120716	0.10-3.00	0.05-0.30	●		●									
	120716 T7	0.10-3.00	0.05-0.30				●								
	150716	0.10-3.50	0.05-0.30			●									
	190716	0.10-4.00	0.05-0.30			●									

● : Standard items



A77, A78,
A128, A129, A159, A160,
A210, A243



SNGX-CH SNMG-CE

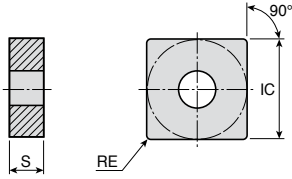

Negative square inserts



Size	Dimension (mm)		
	IC	S	RE
12	12.7	4.76-7.94	0.8-1.6
15	15.8 8	7.94	1.6

Insert	Designation	ap (mm)	Feed (mm/rev)	Ceramic										
				AB2010	AB20	AB30	AW120	SC500	AS500	SC10	AS10	TC430	TC3020	TC3030
 Dimple type	SNGX 120712 CH	0.10-3.00	0.05-0.30							●	●			
	120716 CH	0.10-3.00	0.05-0.35							●	●			
	120716 T7-CH	0.10-3.00	0.05-0.35					●	●		●			
	150716 T7-CH	0.10-3.50	0.05-0.35								●			
 Pressed type	SNMG 120408 CE	0.10-3.00	0.05-0.20			●								



 A77, A78,
 A128, A129, A152,
 A210, A243

● : Standard items

TNGA TNGN TNMG-CE

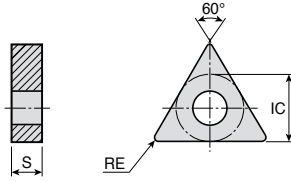

Negative triangular inserts



Size	Dimension (mm)		
	IC	S	RE
16	9.52	4.76	0.4-1.6
22	12.7	4.76	0.4-1.6

Insert	Designation	ap (mm)	Feed (mm/rev)	Ceramic											
				AB2010	AB20	AB30	AW120	AS500	SC10	AS10	TC430	TC3020	TC3030		
	TNGA 160404	0.10-2.50	0.05-0.15	●	●	●									
	160404 T2	0.10-2.50	0.05-0.15			●									
	160408	0.10-2.50	0.05-0.20	●	●	●									
	160408 T2	0.10-2.50	0.05-0.20			●									
	160412	0.10-2.50	0.05-0.25	●	●	●									
	160412 T2	0.10-2.50	0.05-0.25			●									
	160416	0.10-2.50	0.05-0.30		●										
	220404	0.10-3.00	0.05-0.15		●	●									
	220408	0.10-3.00	0.05-0.20	●	●	●									
	220412	0.10-3.00	0.05-0.25		●	●									
	220416	0.10-3.00	0.05-0.30		●	●									
	TNGN 160404	0.10-2.50	0.05-0.15		●	●									
	160408	0.10-2.50	0.05-0.20	●	●	●					●				
	160408 T7	0.10-2.50	0.05-0.20				●								
	160412	0.10-2.50	0.05-0.25		●	●									
	160412 T7	0.10-2.50	0.05-0.25				●	●							
	160416 T7	0.10-1.00	0.05-0.20				●								
	TNMG 160408 CE	0.10-2.50	0.05-0.20			●									

Pressed type

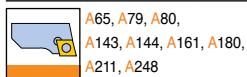

●: Standard items



VNGA VNGX-CH

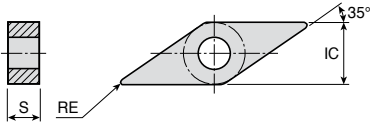

Negative 35° rhombic inserts



Size	Dimension (mm)		
	IC	S	RE
16	9.52	4.76-7.94	0.4-1.2
22	12.7	4.76	1.2

Insert	Designation	ap (mm)	Feed (mm/rev)	Ceramic										
				AB2010	AB20	AB30	AW120	AS500	SC10	AS10	TC430	TC3020	TC3030	
	VNGA 160404	0.05-1.00	0.05-0.10	●	●	●								
	160408	0.05-1.00	0.05-0.15	●	●	●								
	160412	0.05-1.50	0.05-0.20		●	●								
	220412	0.05-2.00	0.05-0.20			●								
 Dimple type	VNGX 160712 T7-CH	0.05-1.50	0.05-0.20							●				



A66, A67

● : Standard items

WNGA



Negative 80° trigon inserts

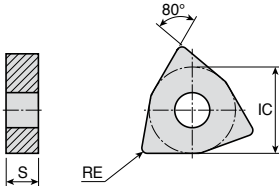

Size	Dimension (mm)		
	IC	S	RE
08	12.7	4.76	0.8-1.2

Insert	Designation	ap (mm)	Feed (mm/rev)	Ceramic										
				AB2010	AB20	AB30	AW120	AS500	SC10	AS10	TC430	TC3020	TC3030	
	WNGA 080408	0.10-2.50	0.05-0.25	●	●	●			●	●				
	080408 T7-WZ	0.10-2.50	0.05-0.25	●	●									
	080412	0.10-2.50	0.05-0.25	●	●	●			●	●				
	080412 T7	0.10-2.50	0.05-0.25					●						



A68, A81,
A136, A181,
A207, A246

● : Standard items

RCGX RPGN RPGX T11-



Positive round inserts

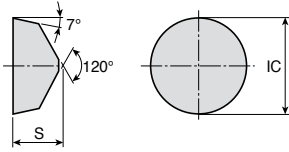

Size	Dimension (mm)		Size	Dimension (mm)	
	IC	S		IC	S
06	6.35	3.18-6.35	19	19.05	10.0
09	9.52	7.94	25	25.4	12.0
12	12.7	4.76-7.94	T11	31.9	19.05
15	15.88	8			

Insert	Designation	ap (mm)	Feed (mm/rev)	Ceramic										
				AB2010	AB20	AB30	AW120	AS500	SC10	AS10	TC430	TC3020	TC3030	
 	RCGX 060600 T6	0.10-2.00	0.05-0.25									●		
	060600 U1	0.10-2.00	0.05-0.25			●								
	090700 E	0.10-3.00	0.05-0.35										●	●
	090700 E04	0.10-3.00	0.05-0.30										●	●
	090700 T6	0.10-3.00	0.05-0.30									●	●	●
	090700 U1	0.10-3.00	0.05-0.30		●	●							●	●
	120700	0.10-4.00	0.05-0.35			●								
	120700 E	0.10-4.00	0.05-0.35										●	●
	120700 E04	0.10-4.00	0.05-0.35										●	●
	120700 T6	0.10-4.00	0.05-0.35									●	●	●
	120700 U2	0.10-4.00	0.05-0.35		●	●							●	●
	151000 U2	0.10-5.00	0.05-0.35		●	●								
	191000 U2	0.10-5.00	0.05-0.35		●	●								
251200 U3 *	0.10-5.00	0.05-0.35			●									
	RPGN 060300 E	0.10-2.00	0.05-0.25											●
	120400 E	0.10-4.00	0.05-0.35										●	●
	120400 T6	0.10-4.00	0.05-0.35									●	●	●
	RPGX 090700 E	0.10-3.00	0.05-0.35										●	●
	090700 T6	0.10-3.00	0.05-0.35									●	●	●
	120700 E	0.10-4.00	0.05-0.35										●	●
	120700 T6	0.10-4.00	0.05-0.35									●	●	●
	T11- 3219	0.10-5.00	0.05-0.35		●									

A145-A147

● * Marked: This is the only item with a 140° bottom

●: Standard items



Positive square inserts

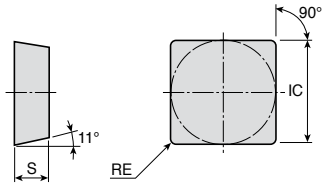

Size	Dimension (mm)		
	IC	S	RE
12	12.7	3.18-4.76	0.8-1.2

Insert	Designation	ap (mm)	Feed (mm/rev)	Ceramic										
				AB2010	AB20	AB30	AW120	AS500	SC10	AS10	TC430	TC3020	TC3030	
	SPGN 120308	0.10-3.50	0.05-0.20			●				●				
	120412	0.10-3.50	0.05-0.20							●				



● : Standard items

TPGN

Positive triangular inserts

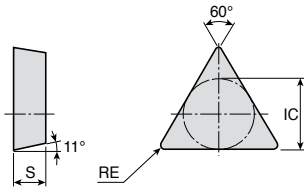

Size	Dimension (mm)		
	IC	S	RE
11	6.35	3.18	0.4-0.8
16	9.52	3.18	0.4-0.8
22	12.7	4.76	0.8

Insert	Designation	ap (mm)	Feed (mm/rev)	Ceramic										
				AB2010	AB20	AB30	AW120	AS500	SC10	AS10	TC430	TC3020	TC3030	
	TPGN 110304	0.10-2.00	0.05-0.10	●	●	●								
	110308	0.10-2.00	0.05-0.10	●	●	●								
	160304	0.10-2.50	0.05-0.15	●	●	●								
	160308	0.10-2.50	0.05-0.20	●	●	●								
	160308 T6	0.10-2.50	0.05-0.20								●			
	220408	0.10-3.00	0.05-0.20			●								



● : Standard items

CNGA CNGN-SD CNGX-DA



Negative 80° rhombic inserts

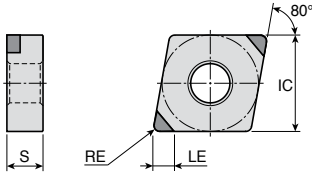

Size	Dimension (mm)		
	IC	S	RE
09	9.52	3.18	0.8
12	12.7	4.76	0.4-1.6

Insert	Designation	LE (mm)	ap (mm)	Feed (mm/rev)	CBN						PCD				
					TB610	TB650	TB670	TB730	TB7015	TB7020	TD810	KP300	TD830		
	CNGA 120404 WZ-LS	2.1	0.10-0.50	0.05-0.30		●									
	120404 WZ-LS2	2.1	0.10-0.50	0.05-0.30	●	●	●								
	120408 WZ-LS	2.1	0.10-0.50	0.05-0.30		●			●						
	120408 WZ-LS2	2.1	0.10-0.50	0.05-0.30	●	●	●	●							
	120408 WZ-LS4	2.1	0.10-0.50	0.05-0.30	●	●	●								
	120412 WZ-LS	2.5	0.10-0.50	0.05-0.30		●			●						
	120412 WZ-LS2	2.5	0.10-0.50	0.05-0.30		●	●	●							
	120412 WZ-LS4	2.5	0.10-0.50	0.05-0.30			●								
	CNGA 120404 LN	4.2	0.10-0.50	0.05-0.30	●		●		●						
	120404 LS	2.2	0.10-0.50	0.05-0.30					●						
	120404 LS2	2.2	0.10-0.50	0.05-0.30	●	●	●	●							
	120404 LS4	2.2	0.10-0.50	0.05-0.30		●	●								
	120408 LN	4.0	0.10-0.50	0.05-0.30	●	●		●	●						
	120408 LN4	4.0	0.10-0.50	0.05-0.30		●									
	120408 LS	2.1	0.10-0.50	0.05-0.30		●			●						
	120408 LS2	2.1	0.10-0.50	0.05-0.30	●	●	●	●	●						
	120408 LS4	2.1	0.10-0.50	0.05-0.30		●	●	●	●						
	120412 LN	3.9	0.10-0.50	0.05-0.30	●		●		●						
	120412 LS2	2.5	0.10-0.50	0.05-0.30		●		●	●						
120412 LS4	2.5	0.10-0.50	0.05-0.30			●	●								
	CNGA 120404 LN-10	4.0	0.10-3.00	0.05-0.25								●	●		
	120408 LN-10	3.9	0.10-3.00	0.05-0.25								●	●		
	120412 LN-10	3.8	0.10-3.00	0.05-0.25									●		
	CNGN 090308 SD	-	0.10-3.00	0.05-0.30						●					
	120412 SD	-	0.10-4.00	0.05-0.30						●					
	120416 SD	-	0.10-4.00	0.05-0.30						●					
	CNGX 120412 DA	-	0.10-4.00	0.05-0.30							●				
	120416 DA	-	0.10-4.00	0.05-0.30							●				

A69-A71, A148, A153, A155, A178, A208, A238

●: Standard items

Negative 55° rhombic inserts

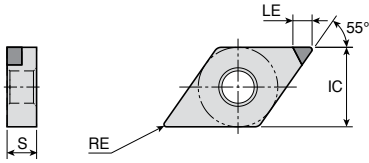

Size	Dimension (mm)		
	IC	S	RE
15	12.7	4.76-6.35	0.4-1.2

Insert	Designation	LE (mm)	ap (mm)	Feed (mm/rev)	CBN					PCD			
					TB610	TB650	TB670	TB730	TB7015	TB7020	TD810	KP300	TD830
	DNGA 150404 LN	4.2	0.10-0.50	0.05-0.30	●	●	●						
	150404 LS	2.6	0.10-0.50	0.05-0.30		●			●				
	150404 LS2	2.6	0.10-0.50	0.05-0.30	●	●	●						
	150404 LS4	2.6	0.10-0.50	0.05-0.30	●	●	●						
	150408 LN	3.9	0.10-0.50	0.05-0.30	●	●	●		●				
	150408 LS	2.3	0.10-0.50	0.05-0.30		●			●				
	150408 LS2	2.3	0.10-0.50	0.05-0.30	●	●	●	●					
	150408 LS4	2.3	0.10-0.50	0.05-0.30			●						
	150412 LN	3.5	0.10-0.50	0.05-0.30		●			●				
	150412 LS2	2.2	0.10-0.50	0.05-0.30			●	●					
	150412 LS4	2.2	0.10-0.50	0.05-0.30			●						
	150604 LN	4.2	0.10-0.50	0.05-0.30		●	●	●	●				
	150604 LS	2.6	0.10-0.50	0.05-0.30		●							
	150604 LS2	2.6	0.10-0.50	0.05-0.30	●	●	●	●					
	150608 LN	3.9	0.10-0.50	0.05-0.30	●	●	●	●					
	150608 LS2	2.3	0.10-0.50	0.05-0.30	●	●	●	●	●				
	150608 LS4	2.3	0.10-0.50	0.05-0.30			●						
150612 LS2	2.2	0.10-0.50	0.05-0.30			●							
	DNGA 150404 LN-10	4.0	0.10-2.50	0.05-0.20							●	●	
	150408 LN-10	3.7	0.10-2.50	0.05-0.20							●	●	
	150604 LN-10	4.0	0.10-2.50	0.05-0.20							●	●	
	150608 LN-10	3.7	0.10-2.50	0.05-0.20							●	●	

● : Standard items

A63, A64,
A72, A73,
A178, A209, A240





SNGA SNGN-SD SNGX-DA

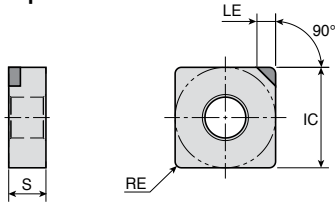

Negative square inserts



Size	Dimension (mm)		
	IC	S	RE
09	9.52	3.18	1.2
12	12.7	4.76	0.4-1.6

Insert	Designation	LE (mm)	ap (mm)	Feed (mm/rev)	CBN						PCD			
					TB610	TB650	TB670	TB730	TB7015	TB7020	TD810	KP300	TD830	
	SNGA 120404 LS2	2.5	0.10-0.50	0.05-0.30			●	●						
	120408 LN	4.2	0.10-0.50	0.05-0.30		●			●					
	120408 LS	2.5	0.10-0.50	0.05-0.30		●								
	120408 LS2	2.5	0.10-0.50	0.05-0.30				●	●					
	120408 LS4	2.5	0.10-0.50	0.05-0.30				●						
	120408 LS8	2.5	0.10-0.50	0.05-0.30				●						
 	SNGA 120408 LN-10	4.0	0.10-3.00	0.05-0.20									●	
	120412 LN-10	4.0	0.10-3.00	0.05-0.20									●	
 Solid CBN	SNGN 090312 SD	-	0.10-3.00	0.05-0.30						●				
	120416 SD	-	0.10-4.00	0.05-0.30						●				
 Dimple type	SNGX 120416 DA	-	0.10-4.00	0.05-0.30						●				

 A77, A78, A128, A129, A154, A159, A160, A210, A243

● : Standard items

Negative triangular inserts

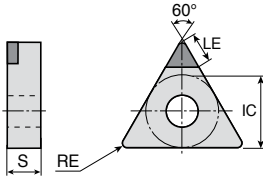

Size	Dimension (mm)		
	IC	S	RE
16	9.52	4.76	0.4-1.2
22	12.7	4.76	0.4-0.8

Insert	Designation	LE (mm)	ap (mm)	Feed (mm/rev)	CBN						PCD			
					TB610	TB650	TB670	TB730	TB7015	TB7020	TD810	KP300	TD830	
	TNGA 160404 LN	4.3	0.10-0.50	0.05-0.30	●	●		●						
	160404 LS	2.2	0.10-0.50	0.05-0.30		●								
	160404 LS3	2.2	0.10-0.50	0.05-0.30	●		●	●						
	160404 LS6	2.2	0.10-0.50	0.05-0.30		●								
	160408 LN	4.0	0.10-0.50	0.05-0.30		●	●		●					
	160408 LS3	2.1	0.10-0.50	0.05-0.30	●	●	●	●	●					
	160408 LS6	2.1	0.10-0.50	0.05-0.30			●							
	160412 LS3	2.5	0.10-0.50	0.05-0.30			●							
	220404 LN	4.1	0.10-0.50	0.05-0.30		●								
	220408 LS	2.6	0.10-0.50	0.05-0.30		●								
	TNGA 160404 LN-10	4.3	0.10-3.00	0.05-0.20								●	●	



- A65, A79, A80,
- A143, A144, A180,
- A211, A248

●: Standard items

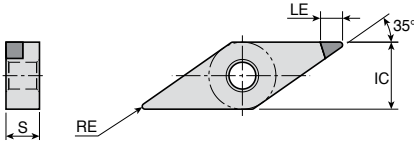
Negative 35° rhombic inserts



Size	Dimension (mm)		
	IC	S	RE
16	9.52	4.76	0.4-0.8

Insert	Designation	LE (mm)	ap (mm)	Feed (mm/rev)	CBN						PCD			
					TB610	TB650	TB670	TB730	TB7015	TB7020	TD810	KP300	TD830	
	VNGA 160404 LN	5.0	0.10-0.50	0.05-0.30		●								
	160404 LS	3.2	0.10-0.50	0.05-0.30		●								
	160404 LS2	3.2	0.10-0.50	0.05-0.30			●	●						
	160408 LN	4.1	0.10-0.50	0.05-0.30		●								
	160408 LS	2.4	0.10-0.50	0.05-0.30					●					
	160408 LS2	2.4	0.10-0.50	0.05-0.30		●	●	●	●					
	160408 LS4	2.4	0.10-0.50	0.05-0.30					●					
 	VNGA 160404 LN-10	5.0	0.10-2.00	0.05-0.20								●	●	
	160408 LN-10	4.1	0.10-2.00	0.05-0.20								●	●	



● : Standard items

CCGW CCGT-CB



Positive 80° rhombic inserts

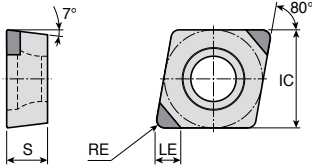

Size	Dimension (mm)		
	IC	S	RE
06	6.35	2.38	0.2-0.8
09	9.52	3.97	0.2-0.8
12	12.7	4.76	0.4-0.8

Insert	Designation	LE (mm)	ap (mm)	Feed (mm/rev)	CBN					PCD				
					TB610	TB650	TB670	TB730	TB7015	TB7020	TD810	KP300	TD830	
	CCGW 060202 LS	2.4	0.05-0.50	0.05-0.30		●			●					
	060202 LS2	2.2	0.05-0.50	0.05-0.30			●	●						
	060204 LS	2.4	0.05-0.50	0.05-0.30		●			●					
	060204 LS2	2.1	0.05-0.50	0.05-0.30	●		●	●						
	060208 LS2	2.1	0.05-0.50	0.05-0.30	●		●	●						
	09T304 LS	2.4	0.05-0.50	0.05-0.30			●		●					
	09T304 LS2	2.4	0.05-0.50	0.05-0.30	●	●	●	●	●					
	09T304 WZ-LS	2.8	0.05-0.50	0.05-0.30		●								
	09T304 WZ-LS2	2.4	0.05-0.50	0.05-0.30			●	●						
	09T308 LS	2.3	0.05-0.50	0.05-0.30		●			●					
	09T308 LS2	2.3	0.05-0.50	0.05-0.30	●		●	●						
	09T308 WZ-LS	2.3	0.05-0.50	0.05-0.30		●								
	09T308 WZ-LS2	2.3	0.05-0.50	0.05-0.30		●		●						
		120404 LS2	2.1	0.05-0.50	0.05-0.30				●					
		120408 LS	2.5	0.05-0.50	0.05-0.30					●				
	120408 LS2	2.1	0.05-0.50	0.05-0.30				●						
	CCGT 060204 CB	3.1	0.50-1.50	0.10-0.50									●	
	09T302 CB	4.15	0.50-2.00	0.10-0.50									●	
	09T304 CB	4.1	0.50-2.00	0.10-0.50									●	
	09T308 CB	4.0	0.50-2.00	0.10-0.50									●	
	120404 CB	4.1	0.50-2.00	0.10-0.50									●	
	120408 CB	4.0	0.50-2.00	0.10-0.50									●	
	CCGW 060202 LN-7	3.1	0.08-3.00	0.05-0.30									●	●
	060204 LN-7	3.1	0.08-3.00	0.05-0.30									●	●
	09T304 LN-7	4.0	0.10-3.00	0.05-0.30									●	●
	09T308 LN-7	3.9	0.10-3.00	0.05-0.30									●	●
	120404 LN-7	4.0	0.10-3.00	0.05-0.30									●	●
	120408 LN-7	3.9	0.10-3.00	0.05-0.30									●	●

PCD chip breaker

A82-A84,
A113, A183,
A212, A213, A255

● : Standard items

DCGW DCGT-CB



Positive 55° rhombic inserts

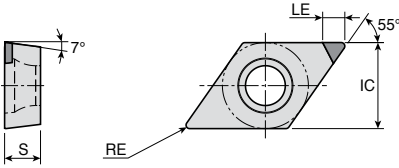

Size	Dimension (mm)		
	IC	S	RE
07	6.35	2.38	0.2-0.8
11	9.52	3.97	0.2-0.8

Insert	Designation	LE (mm)	ap (mm)	Feed (mm/rev)	CBN						PCD					
					TB610	TB650	TB670	TB730	TB7015	TB7020	TD810	KP300	TD830			
	DCGW 070202 LS	2.6	0.05-0.50	0.05-0.30		●										
	070202 LS2	2.6	0.05-0.50	0.05-0.30	●		●	●								
	070204 LS	2.4	0.05-0.50	0.05-0.30		●				●						
	070204 LS2	2.4	0.05-0.50	0.05-0.30	●		●	●								
	070208 LS2	2.6	0.05-0.50	0.05-0.30					●							
	11T304 LS	2.6	0.05-0.50	0.05-0.30		●				●						
	11T304 LS2	3.4	0.05-0.50	0.05-0.30	●		●	●								
	11T308 LS	2.2	0.05-0.50	0.05-0.30		●				●						
	11T308 LS2	2.2	0.05-0.50	0.05-0.30	●		●	●								
 PCD chip breaker	DCGT 070202 CB	3.4	0.50-1.50	0.10-0.50												●
	070204 CB	3.3	0.50-1.50	0.10-0.50												●
	11T302 CB	4.9	0.50-2.50	0.10-0.50												●
	11T304 CB	4.7	0.50-2.50	0.10-0.50												●
	11T308 CB	4.4	0.50-2.50	0.10-0.50												●
	DCGW 070202 LN-7	3.4	0.10-2.00	0.05-0.30											●	●
	070204 LN-7	3.3	0.10-2.00	0.05-0.30											●	●
	11T302 LN-7	3.9	0.10-2.00	0.05-0.30											●	●
	11T304 LN-7	3.7	0.10-2.00	0.05-0.30											●	●
	11T308 LN-7	3.3	0.10-2.00	0.05-0.30											●	●

A87, A88, A91, A92, A114,
 A117, A119, A166, A171,
 A183, A217-A219, A257

●: Standard items

Positive round inserts

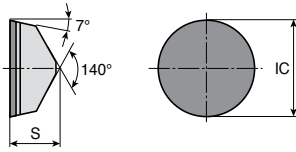

Size	Dimension (mm)	
	IC	S
06	6.35	3.18
09	9.52	3.18
12	12.7	4.76

Insert	Designation	LE (mm)	ap (mm)	Feed (mm/rev)	CBN					PCD			
					TB610	TB650	TB670	TB730	TB7015	TB7020	TD810	KP300	TD830
 Full Top CBN	RCGX 060300 FT	-	0.10-1.00	0.05-0.30					●				
	090300 FT	-	0.10-1.50	0.05-0.30					●				
	120400 FT	-	0.10-1.50	0.05-0.30					●				



● : Standard items

SCGW

Positive square inserts

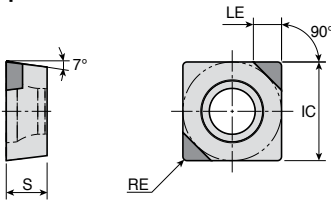

Size	Dimension (mm)		
	IC	S	RE
09	9.52	3.18-3.97	0.4-0.8

Insert	Designation	LE (mm)	ap (mm)	Feed (mm/rev)	CBN					PCD		
					TB610	TB650	TB670	TB730	TB7015	TB7020	TD810	KP300
	SCGW 09T304 LS2	2.7	0.05-0.50	0.05-0.30					●			
	09T308 LS2	2.7	0.05-0.50	0.05-0.30					●			



● : Standard items

Positive triangular inserts

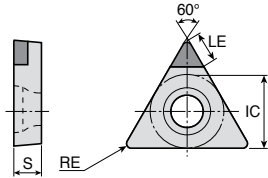

Size	Dimension (mm)		
	IC	S	RE
08	4.76	2.38	0.4
09	5.56	2.38	0.4-0.8
11	6.35	2.38-3.18	0.2-0.8
16	9.52	3.18-4.76	0.4-0.8

Insert	Designation	LE (mm)	ap (mm)	Feed (mm/rev)	CBN						PCD				
					TB610	TB650	TB670	TB730	TB7015	TB7020	TD810	KP300	TD830		
	TCGW 090204 LS3	2.3	0.05-0.50	0.05-0.30			●	●							
	110204 LS	2.3	0.05-0.50	0.05-0.30		●			●						
	110204 LS3	2.3	0.05-0.50	0.05-0.30	●		●	●							
	110208 LS	2.1	0.05-0.50	0.05-0.30		●			●						
	110208 LS3	2.1	0.05-0.50	0.05-0.30			●	●							
	16T304 LS	2.8	0.05-0.50	0.05-0.30		●			●						
	16T304 LS3	2.8	0.05-0.50	0.05-0.30			●	●							
	16T308 LS	2.5	0.05-0.50	0.05-0.30		●			●						
	16T308 LS3	2.5	0.05-0.50	0.05-0.30	●		●	●							
	TPGN 090204 LS3	2.3	0.05-0.50	0.05-0.30	●										
	110302 LS3	2.8	0.05-0.50	0.05-0.30					●						
	110304 LS	2.6	0.05-0.50	0.05-0.30		●				●					
	110304 LS3	2.6	0.05-0.50	0.05-0.30					●						
	110308 LS3	2.3	0.05-0.50	0.05-0.30	●		●								
	160304 LS	2.8	0.05-0.50	0.05-0.30		●									
	160304 LS3	2.8	0.05-0.50	0.05-0.30	●		●								
	160308 LS	2.5	0.05-0.50	0.05-0.30		●									
	160308 LS3	2.5	0.05-0.50	0.05-0.30	●		●	●							
	TPGW 080204 LS3	2.1	0.05-0.50	0.05-0.30				●							
	090204 LS3	2.3	0.05-0.50	0.05-0.30			●	●							
	090208 LS3	2.0	0.05-0.50	0.05-0.30				●							
	110302 LS3	2.8	0.05-0.50	0.05-0.30	●										
	110304 LS	2.6	0.05-0.50	0.05-0.30		●	●								
	110304 LS3	2.6	0.05-0.50	0.05-0.30	●				●						
	110308 LS3	2.3	0.05-0.50	0.05-0.30	●		●								
	160404 LS3	2.8	0.05-0.50	0.05-0.30			●								

A53, A54, A98-A100,
A184, A198, A221,
A223, A224, A259

●: Standard items

TCGT-CB TCGW TPGN



Positive triangular inserts

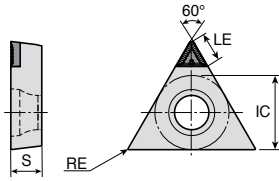

Size	Dimension (mm)		
	IC	S	RE
09	5.56	2.38	0.4-0.8
11	6.35	2.38-3.18	0.2-0.8
16	9.52	3.18-3.97	0.2-0.8

Insert	Designation	LE (mm)	ap (mm)	Feed (mm/rev)	CBN					PCD			
					TB610	TB650	TB670	TB730	TB7015	TB7020	TD810	KP300	TD830
 PCD chip breaker 	TCGT 090204 CB	2.8	0.50-1.50	0.10-0.50							●		
	110204 CB	3.8	0.50-2.00	0.10-0.50							●		
	16T304 CB	3.9	0.50-2.00	0.10-0.50							●		
	16T308 CB	3.6	0.50-2.00	0.10-0.50							●		
 	TCGW 090204 LN-7	3.3	0.10-2.00	0.05-0.30								●	
	090208 LN-7	3.0	0.10-2.00	0.05-0.30								●	
	110204 LN-7	3.8	0.10-2.00	0.05-0.30							●	●	
	110208 LN-7	3.5	0.10-2.00	0.05-0.30								●	
	16T304 LN-7	3.8	0.10-2.00	0.05-0.30								●	
	16T308 LN-7	3.5	0.10-2.00	0.05-0.30							●	●	
 	TPGN 110302 LN-7	3.9	0.10-2.00	0.05-0.30								●	
	110304 LN-7	3.8	0.10-2.00	0.05-0.30								●	
	160302 LN-7	4.4	0.10-2.00	0.05-0.30								●	
	160304 LN-7	4.3	0.10-2.00	0.05-0.30								●	

A53, A54, A98-A100,
 A184, A198,
 A221, A259

● : Standard items

VBGW VCGT-CB VCGW



Positive 35° rhombic inserts

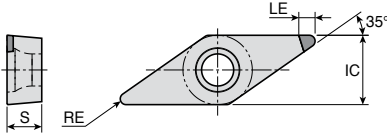

Size	Dimension (mm)		
	IC	S	RE
11	6.35	3.18	0.2-0.4
16	9.52	4.76	0.2-1.2
22	12.7	5.56	3.0

Insert	Designation	LE (mm)	ap (mm)	Feed (mm/rev)	CBN						PCD			
					TB610	TB650	TB670	TB730	TB7015	TB7020	TD810	KP300	TD830	
	VBGW 110304 LS2	3.2	0.05-0.50	0.05-0.30			●							
	160402 LS2	3.6	0.05-0.50	0.05-0.30			●							
	160404 LS	3.2	0.05-0.50	0.05-0.30		●			●					
	160404 LS2	3.2	0.05-0.50	0.05-0.30	●		●	●						
	160408 LS	2.3	0.05-0.50	0.05-0.30	●		●		●					
	160408 LS2	2.3	0.05-0.50	0.05-0.30	●		●	●						
 	VBGW 160402 LN-7	5.2	0.10-2.00	0.05-0.30								●	●	
	160404 LN-7	5.0	0.10-2.00	0.05-0.30								●	●	
	160408 LN-7	4.2	0.10-2.00	0.05-0.30								●	●	
 	VCGT 110302 CB	4.7	0.50-2.00	0.10-0.50									●	
	110304 CB	5.0	0.50-2.00	0.10-0.50									●	
	160404 CB	7.3	0.50-3.50	0.10-0.50									●	
	160408 CB	6.4	0.50-3.50	0.10-0.50									●	
	160412 CB	6.2	0.50-3.50	0.10-0.50									●	
	220530 CB	6.4	0.50-3.50	0.10-0.50									●	
 	VCGW 110304 LN-7	5.0	0.10-2.00	0.05-0.30									●	
	160404 LN-7	5.0	0.10-2.00	0.05-0.30									●	●
	160408 LN-7	4.1	0.10-2.00	0.05-0.30									●	●

- A102, A103, A108-A110,
- A116, A118, A119, A168, A169, A185,
- A228, A230, A232, A233, A260

●: Standard items

Recommended Cutting Conditions

Machining data for turning grades

ISO	Material	Condition	Tensile strength (N/mm ²)	Hardness HB	Material No.	
P	Non-alloy steel, cast steel, free cutting steel	<0.25%C	Annealed	420	125	1
		≥0.25%C	Annealed	650	190	2
		<0.55%C	Quenched and tempered	850	250	3
		≥0.55%C	Annealed	750	220	4
			Quenched and tempered	1000	300	5
	Low alloy steel and cast steel (less than 5% of alloying elements)	Annealed		600	200	6
				930	275	7
		Quenched and tempered		1000	300	8
				1200	350	9
	High alloy steel, cast steel and tool steel	Annealed	680	200	10	
		Quenched and tempered	1100	325	11	
M	Stainless steel and cast steel	Ferritic / martensitic	680	200	12	
		Martensitic	820	240	13	
		Austenitic	600	180	14	
K	Gray cast iron (GG)	Ferritic		160	15	
		Pearlitic		250	16	
	Cast iron nodular (GGG)	Ferritic		180	17	
		Pearlitic		260	18	
	Malleable cast iron	Ferritic		130	19	
	Pearlitic		230	20		
N	Aluminum - wrought alloy	Not cureable		60	21	
		Cured		100	22	
	Aluminum-cast, alloyed	<=12% Si	Not cureable		75	23
			Cured		90	24
		>12% Si	High temp.		130	25
	Copper alloys	>1% Pb	Free cutting		110	26
					90	27
			Electrolitic copper		100	28
	Non-metallic		Duroplastics, fiber plastics			29
			Hard rubber			30
S	High temp. alloys	Fe based	Annealed	200	31	
			Cured	280	32	
		Ni or Co based	Annealed	250	33	
			Cured	350	34	
			Cast	320	35	
	Titanium, Ti alloys		Rm 400		36	
	Alpha+beta alloys cured	Rm 1050		37		
H	Hardened steel	Hardened		55HRC	38	
		Hardened		60HRC	39	
	Chilled cast iron	Cast		400	40	
	Cast iron nodular	Hardened		55HRC	41	

• For more information of material groups, see the materials & grades "material conversion table"

■ Steel
 ■ Stainless steel
 ■ Cast iron
 ■ Nonferrous
 ■ High temp. alloys
 ■ Hardened steel

Recommended Cutting Conditions

Machining data for turning grades

ISO	Material	Condition	Tensile strength (N/mm ²)	Hardness HB	Material No.	
P	Non-alloy steel, cast steel, free cutting steel	<0.25%C	Annealed	420	125	1
		≥0.25%C	Annealed	650	190	2
		<0.55%C	Quenched and tempered	850	250	3
		≥0.55%C	Annealed	750	220	4
			Quenched and tempered	1000	300	5
	Low alloy steel and cast steel (less than 5% of alloying elements)	Annealed		600	200	6
				930	275	7
		Quenched and tempered		1000	300	8
				1200	350	9
	High alloy steel, cast steel and tool steel	Annealed		680	200	10
		Quenched and tempered		1100	325	11
M	Stainless steel and cast steel	Ferritic / martensitic		680	200	12
		Martensitic		820	240	13
		Austenitic		600	180	14
K	Gray cast iron (GG)	Ferritic		160	15	
		Pearlitic		250	16	
	Cast iron nodular (GGG)	Ferritic		180	17	
		Pearlitic		260	18	
	Malleable cast iron	Ferritic		130	19	
	Pearlitic		230	20		
N	Aluminum - wrought alloy	Not cureable		60	21	
		Cured		100	22	
	Aluminum-cast, alloyed	<=12% Si	Not cureable		75	23
			Cured		90	24
		>12% Si	High temp.		130	25
	Copper alloys	>1% Pb	Free cutting		110	26
			Brass		90	27
			Electrolitic copper		100	28
	Non-metallic		Duroplastics, fiber plastics			29
			Hard rubber			30
S	High temp. alloys	Fe based	Annealed		200	31
			Cured		280	32
		Ni or Co based	Annealed		250	33
			Cured		350	34
			Cast		320	35
	Titanium, Ti alloys			Rm 400		36
Alpha+beta alloys cured			Rm 1050		37	
H	Hardened steel	Hardened		55HRC	38	
		Hardened		60HRC	39	
	Chilled cast iron	Cast		400	40	
	Cast iron nodular	Hardened		55HRC	41	

• For more information of material groups, see the materials & grades "material conversion table"

■ Steel
 ■ Stainless steel
 ■ Cast iron
 ■ Nonferrous
 ■ High temp. alloys
 ■ Hardened steel

Recommended Cutting Conditions

Machining data for turning grades

ISO	Material	Condition	Tensile strength (N/mm ²)	Hardness HB	Material No.	
P	Non-alloy steel, cast steel, free cutting steel	<0.25%C	Annealed	420	125	1
		≥0.25%C	Annealed	650	190	2
		<0.55%C	Quenched and tempered	850	250	3
		≥0.55%C	Annealed	750	220	4
			Quenched and tempered	1000	300	5
	Low alloy steel and cast steel (less than 5% of alloying elements)	Annealed		600	200	6
				930	275	7
		Quenched and tempered		1000	300	8
				1200	350	9
	High alloy steel, cast steel and tool steel	Annealed		680	200	10
		Quenched and tempered		1100	325	11
M	Stainless steel and cast steel	Ferritic / martensitic		680	200	12
		Martensitic		820	240	13
		Austenitic		600	180	14
K	Gray cast iron (GG)	Ferritic		160	15	
		Pearlitic		250	16	
	Cast iron nodular (GGG)	Ferritic		180	17	
		Pearlitic		260	18	
	Malleable cast iron	Ferritic		130	19	
	Pearlitic		230	20		
N	Aluminum - wrought alloy	Not cureable		60	21	
		Cured		100	22	
	Aluminum-cast, alloyed	≤12% Si	Not cureable		75	23
			Cured		90	24
		>12% Si	High temp.		130	25
	Copper alloys	>1% Pb	Free cutting		110	26
			Brass		90	27
			Electrolytic copper		100	28
	Non-metallic		Duroplastics, fiber plastics			29
			Hard rubber			30
S	High temp. alloys	Fe based	Annealed		200	31
			Cured		280	32
		Ni or Co based	Annealed		250	33
			Cured		350	34
			Cast		320	35
	Titanium, Ti alloys			Rm 400		36
		Alpha+beta alloys cured		Rm 1050		37
H	Hardened steel	Hardened		55HRC	38	
		Hardened		60HRC	39	
	Chilled cast iron	Cast		400	40	
	Cast iron nodular	Hardened		55HRC	41	

• For more information of material groups, see the materials & grades "material conversion table"

■ Steel
 ■ Stainless steel
 ■ Cast iron
 ■ Nonferrous
 ■ High temp. alloys
 ■ Hardened steel

Recommended Cutting Conditions

Machining data for turning grades

Cutting speed Vc(m/min)								
Uncoated	Cermet		Ceramic					
K10	PV3010	CT3000	AW120	AB2010	AB20	AB30	TC430	TC3020
	350-650	300-570						
	270-520	250-500						
	240-480	220-460						
	260-500	240-470						
	240-460	220-440						
	240-540	220-520						
	190-330	170-300						
	170-300	150-270						
	140-270	130-250						
	260-405	250-395						
	140-205	130-195						
	200-300	180-270						
	200-270	170-250						
	170-260	150-240						
110-180	230-330	220-320				600-1200		
95-140	215-290	205-280				500-900		
95-135	145-220	135-200	600-1200			450-610		
90-125	105-150	95-140	500-900			350-510		
110-140	170-265	160-255	600-800			600-800		
90-125	180-240	170-230	500-700			500-700		
200-1000								
200-1000								
50-400								
50-500								
40-350								
50-500								
50-500								
30-300								
50-300								
50-150								
55-85								200-350
40-65								200-350
32-55							270-400	200-350
21-40							230-330	200-350
16-26							210-300	200-350
50-75								
45-70								
				95-145	90-140	50-100		
						60-120		
						50-100		

Recommended Cutting Conditions

Machining data for turning grades

ISO	Material	Condition	Tensile strength (N/mm ²)	Hardness HB	Material No.	
P	Non-alloy steel, cast steel, free cutting steel	<0.25%C	Annealed	420	125	1
		≥0.25%C	Annealed	650	190	2
		<0.55%C	Quenched and tempered	850	250	3
		≥0.55%C	Annealed	750	220	4
			Quenched and tempered	1000	300	5
	Low alloy steel and cast steel (less than 5% of alloying elements)		Annealed	600	200	6
			Quenched and tempered	930	275	7
				1000	300	8
				1200	350	9
	High alloy steel, cast steel and tool steel		Annealed	680	200	10
			Quenched and tempered	1100	325	11
M	Stainless steel and cast steel	Ferritic / martensitic	680	200	12	
		Martensitic	820	240	13	
		Austenitic	600	180	14	
K	Gray cast iron (GG)	Ferritic		160	15	
		Pearlitic		250	16	
	Cast iron nodular (GGG)	Ferritic		180	17	
		Pearlitic		260	18	
	Malleable cast iron	Ferritic		130	19	
	Pearlitic		230	20		
N	Aluminum - wrought alloy	Not cureable		60	21	
		Cured		100	22	
	Aluminum-cast, alloyed	<=12% Si	Not cureable		75	23
			Cured		90	24
		>12% Si	High temp.		130	25
	Copper alloys		>1% Pb	Free cutting	110	26
				Brass	90	27
				Electrolytic copper	100	28
	Non-metallic		Duroplastics, fiber plastics			29
			Hard rubber			30
S	High temp. alloys	Fe based	Annealed	200	31	
			Cured	280	32	
		Ni or Co based	Annealed	250	33	
			Cured	350	34	
			Cast	320	35	
	Titanium, Ti alloys			Rm 400		36
Alpha+beta alloys cured			Rm 1050		37	
H	Hardened steel	Hardened		55HRC	38	
		Hardened		60HRC	39	
	Chilled cast iron	Cast		400	40	
	Cast iron nodular	Hardened		55HRC	41	

• For more information of material groups, see the materials & grades "material conversion table"

■ Steel
 ■ Stainless steel
 ■ Cast iron
 ■ Nonferrous
 ■ High temp. alloys
 ■ Hardened steel

Recommended Cutting Conditions

Machining data for turning grades

ISO	Material	Condition	Tensile strength (N/mm ²)	Hardness HB	Material No.	
P	Non-alloy steel, cast steel, free cutting steel	<0.25%C	Annealed	420	125	1
		≥0.25%C	Annealed	650	190	2
		<0.55%C	Quenched and tempered	850	250	3
		≥0.55%C	Annealed	750	220	4
			Quenched and tempered	1000	300	5
	Low alloy steel and cast steel (less than 5% of alloying elements)		Annealed	600	200	6
			Quenched and tempered	930	275	7
				1000	300	8
				1200	350	9
	High alloy steel, cast steel and tool steel		Annealed	680	200	10
			Quenched and tempered	1100	325	11
M	Stainless steel and cast steel	Ferritic / martensitic	680	200	12	
		Martensitic	820	240	13	
		Austenitic	600	180	14	
K	Gray cast iron (GG)	Ferritic		160	15	
		Pearlitic		250	16	
	Cast iron nodular (GGG)	Ferritic		180	17	
		Pearlitic		260	18	
	Malleable cast iron	Ferritic		130	19	
	Pearlitic		230	20		
N	Aluminum - wrought alloy	Not cureable		60	21	
		Cured		100	22	
	Aluminum-cast, alloyed	<=12% Si	Not cureable		75	23
			Cured		90	24
		>12% Si	High temp.		130	25
	Copper alloys		>1% Pb	Free cutting	110	26
				Brass	90	27
				Electrolitic copper	100	28
	Non-metallic		Duroplastics, fiber plastics			29
			Hard rubber			30
S	High temp. alloys	Fe based	Annealed	200	31	
			Cured	280	32	
		Ni or Co based	Annealed	250	33	
			Cured	350	34	
			Cast	320	35	
	Titanium, Ti alloys			Rm 400		36
Alpha+beta alloys cured			Rm 1050		37	
H	Hardened steel	Hardened		55HRC	38	
		Hardened		60HRC	39	
	Chilled cast iron	Cast		400	40	
	Cast iron nodular	Hardened		55HRC	41	

• For more information of material groups, see the materials & grades "material conversion table"

■ Steel
 ■ Stainless steel
 ■ Cast iron
 ■ Nonferrous
 ■ High temp. alloys
 ■ Hardened steel



PARTING & GROOVING

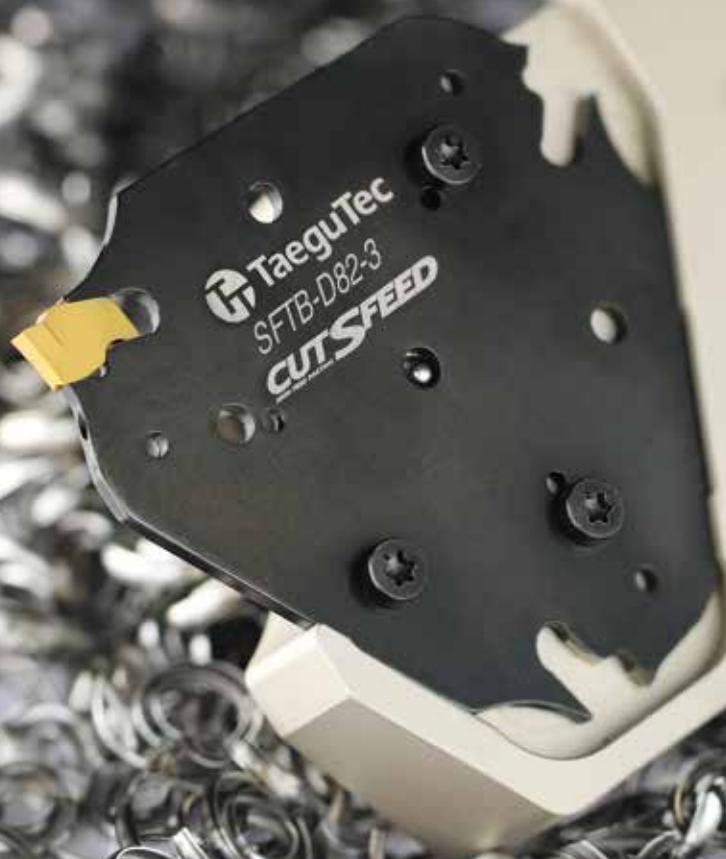

PARTING & GROOVING



contents

Tool Selection Guide

Holder Selection Guide	B4
Insert Selection Guide	B17
Grades	B24
Chip Breakers	B26
Toolholders	
CUT-SFEED	B30
T-CLAMP	B36
FLEX-TURN	B58
FACE-RUSH	B88
T-GROOVE	B92
TOP-CUT	B93
QUAD-RUSH	B95
QUAD-I-RUSH	B104
MINI-I-RUSH	B105
COOL-BURST Accessories	B106

Guide to Icons



➤ Holder Page



➤ Sleeve Page



➤ Insert Page



➤ Cutting Condition Page

















Inserts and Solid Bars

Insert Designation System	B110
CUT-SFEED	B112
T-CLAMP	B113
FACE-RUSH	B127
T-GROOVE	B128
TOP-MICRO Designation System	B129
TOP-MICRO	B130
TOP-CUT Designation System	B142
TOP-CUT	B143
QUAD-RUSH Designation System	B146
QUAD-RUSH	B147
QUAD-I-RUSH	B160
MINI-I-RUSH	B161
Tailor-made Designation System	B162
Tailor-made Insert	B163
Recommended Cutting Conditions	B167







Tool Selection Guide

Parting and grooving holders

				CUT SPEED			
				SFGB	SFGB-TB	SFER/L	SFER/L-TB
Series							
Pages				B30	B31	B32	B33
Application	External	Parting		●	●	●	●
		Grooving		●	●	●	●
		Turning					
	Facing	Grooving					
		Turning					
	Internal	Grooving					
		Turning					
	Profiling						
	Threading						
	Undercut						

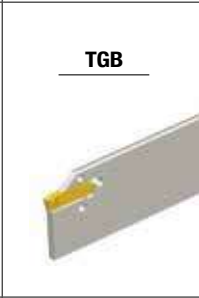
Tool Selection Guide















Parting and grooving holders

				
				
B34	B36	B37	B38	B39-B41
●	●	●	●	●
●	●	●	●	●

● Recommended, ○ Suitable







Tool Selection Guide

Parting and grooving holders

			T-CLAMP <small>FOR FINE & GROOVING</small>			
			<u>TGBFR/L</u>	<u>TGER/L</u>	<u>TCAER/L</u>	<u>COOLBURST</u> <u>TCAER/L-TB</u>
Series						
Pages			B42	B43	B47	B48
Application	External	Parting		●	●	●
		Grooving		●	●	●
		Turning			●	●
	Facing	Grooving		●		
		Turning				
	Internal	Grooving				
		Turning				
	Profiling				●	●
	Threading					
	Undercut					

Tool Selection Guide











Parting and grooving holders

T-CLAMP <small>PARTING & GROOVING</small>	QUADRUSH <small>COOLBURST</small>		FLEXTURN <small>COOLBURST</small>		T-CLAMP <small>PARTING & GROOVING</small>
<u>TCAFR/L</u>	<u>TCAQR/L</u>	<u>TCAQR/L-TB</u>	<u>QE1 TTER/L</u> <u>QE1 TTER/L-TB</u>	<u>QE1 TQHR</u> <u>QE1 TQHR-TB</u>	<u>TTER/L-SH</u>
					
B49	B50	B51	B58- B59	B60	B63
	●	●	●	●	●
	●	●	●	●	●
	○	○	●	●	●
●					
●					
	○	○	●	○	●
	●	●		●	

● Recommended, ○ Suitable

Tool Selection Guide

Parting and grooving holders

Series			T-CLAMP <small>FOR FINE & GROOVING</small>				
			<small>COOLBURST</small> TTER/L-SH-TB	TTER/L-D	TTER/L	<small>COOLBURST</small> TTER/L-TB	
Pages			B64	B65-B66	B67-B68	B69	
Application	External	Parting		●	●	●	●
		Grooving		●	●	●	●
		Turning		●	●	●	●
	Facing	Grooving					
		Turning					
	Internal	Grooving					
		Turning					
	Profiling			●	●	●	●
	Threading						
	Undercut						

Tool Selection Guide

Parting and grooving holders



<u>TTSER/L</u>	<u>TGFR/L</u>	<u>TTFR/L</u>	<u>TTFR/L-RN</u>	<u>TGFPR/L</u>	<u>TTFPR/L</u>
B70	B71	B72	B73-B74	B75	B76
○					
●	●			●	
●	○			○	
	●	●	●	●	●
	○	●	●	○	●
○					

● Recommended, ○ Suitable

Tool Selection Guide







Parting and grooving holders

Series			T-CLAMP <small>Parting & Grooving</small>				
			<u>TGIFR/L</u>	<u>TTFIR/L</u>	<u>TTIR/L-C</u> <u>TTIR/L</u>	COOLBURST <u>TTIR/L-TB</u>	
Pages			B77	B78	B79-B80	B81	
Application	External	Parting					
		Grooving					
		Turning					
	Facing	Grooving		●	●		
		Turning		○	●		
	Internal	Grooving				●	●
		Turning				●	●
	Profiling						
	Threading						
	Undercut						

Tool Selection Guide

Parting and grooving holders













<u>TTSIR/L</u>	<u>TGSIR/L</u>	<u>TGEUR/L</u>	<u>TGIUR/L</u>	<u>TTER/L-15A</u>	<u>TGIUR/L-15A</u>
					
B82	B83	B84	B85	B86	B87
●	●				
●			○		
				●	●
		●	●		

● Recommended, ○ Suitable





Tool Selection Guide

Parting and grooving holders

Series				<i>FACE RUSH</i>			
				<u>TXFR/L</u>	<i>COOLBURST</i> <u>TXFR/L-TB</u>	<u>TXFPR/L</u>	<i>COOLBURST</i> <u>TXFPR/L-TB</u>
Pages				B88	B89	B90	B91
Application	External	Parting					
		Grooving		○	○		
		Turning		○	○		
	Facing	Grooving		●	●	●	●
		Turning		●	●	●	●
	Internal	Grooving					
		Turning					
	Profiling						
	Threading			○	○		
	Undercut						

Tool Selection Guide















Parting and grooving holders

<i>T</i> GROOVE	<i>TOP</i> CUT		<i>QUAD</i> RUSH	
<u>TTLEN</u>	<u>TTVER/L</u>	<u>TTVBR/L</u>	<u>TQHR/L-20</u>	<i>COOL</i> BURST <u>TQHR/L-20-TB</u>
				
B92	B93	B94	B95	B96
	●		●	●
●	●		●	●
	●	●	●	●
			○	○
		●	●	●

● Recommended, ○ Suitable





Tool Selection Guide

Parting and grooving holders

				QUADRUSH			
				<u>TQBR/L-27</u>	<u>TQHR/L-27</u>	COOLBURST <u>TQHR/L-27-TB</u>	<u>TQHPR/L-27</u>
Series							
Pages				B97	B98	B99	B100
Application	External	Parting		●	●	●	●
		Grooving		●	●	●	●
		Turning			○	○	○
	Facing	Grooving					
		Turning					
	Internal	Grooving					
		Turning					
	Profiling				○	○	○
	Threading				●	●	●
	Undercut						

Tool Selection Guide

Parting and grooving holders

QUAD RUSH			QUAD RUSH	MINI RUSH
<u>TQHR/L-34</u>	COOLBURST <u>TQHR/L-34-TB</u>	<u>TQHPR/L-34</u>	<u>TQHIR/L</u>	<u>TMIHN</u> <u>TMIHN-C</u>
				
B101	B102	B103	B104	B105
●	●	●		
●	●	●		
○	○	○		
			●	●
			○	○
○	○	○		

● Recommended, ○ Suitable















Tool Selection Guide

Internal application by diameter

Internal diameter (mm)	TOP <i>MICRO</i>	MINI <i>RUSH</i>	TOP <i>CAP</i>	T- <i>CLAMP</i> <small>INTERNAL & EXTERNAL</small>	QUAD <i>RUSH</i>	T- <i>CLAMP</i> <small>INTERNAL & EXTERNAL</small>
	MIN	TMIHN	TCAP	TTSIR/L	TQHIR/L	TTIR/L
0						
0.6						
1						
2						
3						
4						
5						
6						
7						
8						
9						
10						
11						
12						
12.5						
13						
14						
15						
16						
17						
18						
19						
20						
21						
22						
23						
24						
25						
26						

Tool Selection Guide

Parting and grooving inserts

		CUT SPEED				T-CLAMP PARTING & GROOVING															
		SFC		SFJ		TDC		TSC													
Series																					
Material		P	M	K	N	S	P	M	N	S	P	M	K	N	S	P	M	K	N	S	
Pages		B112		B112		B113		B114													
Application	External	Parting			●	●	●	●													
		Grooving			●	●	●	●													
		Turning																			
	Facing	Grooving							○	○											
		Turning																			
	Internal	Grooving							○	○											
		Turning																			
	Profiling																				
	Threading																				
	Undercut																				

● Recommended, ○ Suitable







Tool Selection Guide

Parting and grooving inserts

Series			T-CLAMP PARTING & GROOVING																	
			TDJ				TSJ				TDUF				TDV					
Material			P	M	N	S	P	M	N	S	P						P	M	N	S
Pages			B115				B116				B117				B117					
Application	External	Parting		●	●	●	●	●	●	●	●	●	●	●	●	●	●	●	●	
		Grooving		●	●	●	●	●	●	●	●	●	●	●	●	●	●	●	●	
		Turning																		
	Facing	Grooving		○	○	○	○	○	○	○	○	○	○	○	○	○	○	○	○	
		Turning																		
	Internal	Grooving		○	○	○	○	○	○	○	○	○	○	○	○	○	○	○	○	
		Turning																		
	Profiling																			
	Threading																			
	Undercut																			

Tool Selection Guide















Parting and grooving inserts

T-CLAMP <small>PARTING & GROOVING</small>						
TDXU	TDXT	TDXY	TDT	TDT (Round Type)	TDT - RS (Round Type)	TDT - RU (Round Type)
						
P M K N S	P M K N S	P M K S	P M K N S	P M K N S	P M K N S	P M K S
B118	B118	B119	B120-B121	B122	B122	B123
○	○	○	○			
●	●	●	●	●	●	●
●	●	●	●	●	●	●
●	●	●	○			
●	●	●	○			
●	●	●	○			
				●	●	●
				●	●	●

● Recommended, ○ Suitable







Tool Selection Guide

Parting and grooving inserts

Series			T-CLAMP <small>PARTING & GROOVING</small>				
			TDFT	TDIT	TDIM	TDIP	
							
Material			P M K N S	P M K N S	P M K N	P M K N S	
Pages			B123	B124	B125	B125	
Application	External	Parting					
		Grooving				●	●
		Turning				○	○
	Facing	Grooving		●		○	○
		Turning		●			
	Internal	Grooving			●	●	●
		Turning			●	●	●
	Profiling					○	
	Threading						
	Undercut				○		

Tool Selection Guide















Parting and grooving inserts

T-CLAMP <small>PARTING & GROOVING</small>			FACE RUSH			T-GROOVE	TOP MICRO
TDA	TSA (PCD)	TSG-HF (CBN)	TDFX	TDGX	TGUX	MIN.	
							
N	N		H P M K N S	P M N S	P M K N	P M N S	
B126	B126	B126	B127	B127	B128	B132-B141	
○		○	○		●		
●		●	○				
			●				
			●				
							●
							●
●	●						●
				●			●
○							

● Recommended, ○ Suitable









Tool Selection Guide

Parting and grooving inserts

			TOPCUT		QUADRUSH			
			TV..	TQJ 20	TQS 20	TQS 20-MT		
Series								
Material			P M N S	P M N S	P M K N S	P M N S		
Pages			B143-B145	B147	B147	B148		
Application	External	Parting		●	●	●		
		Grooving		●	●	●		
		Turning		●	●	●		
	Facing	Grooving						
		Turning						
	Internal	Grooving						
		Turning						
	Profiling				○			
	Threading		●			●		
	Undercut							

Tool Selection Guide

Parting and grooving inserts

QUAD RUSH					QUAD RUSH	MINI RUSH	
TQJ 27	TQC 27	TQS 27	TQS 27-MT TQS 27-WT	TQS 27-ISO TQS 27-UN TQS 27-W	TQC 34	TQIS 14	TMIS 8
							
P M N S	P M K N S	P M K N S	P M N S	P M N S	P M K N S	P M K N S	P M K N S
B149-B151	B152-B153	B154	B155	B156-B157	B157-B159	B160	B161
●	●	●			●		
●	●	●			●		
●	●	●			●		
						●	●
						○	○
○	○	○			○		
			●	●			

● Recommended, ○ Suitable

Grades

Selection guide for parting and grooving grades

For steel (PVD & CVD coated)

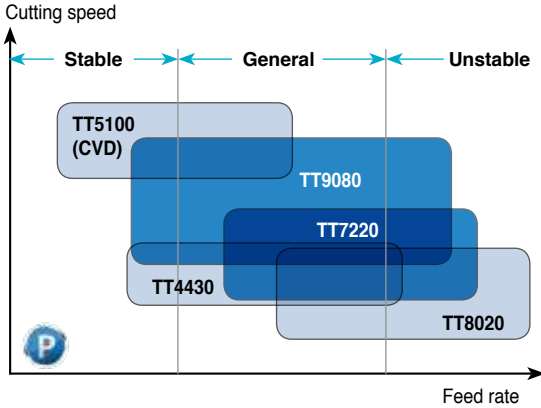

For stainless steel & super alloy (PVD coated)

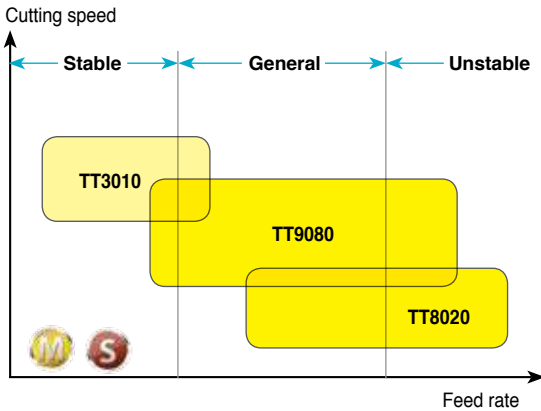

For cast iron (PVD & CVD coated)

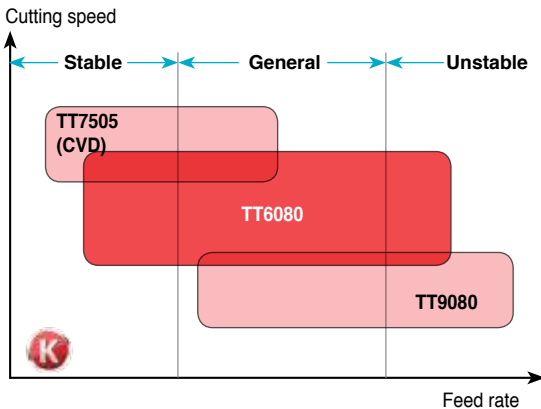







Grades

Parting and grooving grades

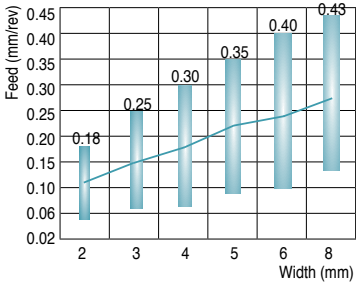
Grades	ISO	Characteristics & applications
TT7505 CVD coated	K05 – K15	<ul style="list-style-type: none"> High speed grooving and turning of gray and ductile cast iron
TT6080 PVD coated	K05 – K25 H05 – H25	<ul style="list-style-type: none"> General machining of gray and ductile cast iron for grooving and turning Finish and medium machining of hardened steel
TT3010 PVD coated	S05 – S20	<ul style="list-style-type: none"> High speed grooving and turning of heat-resistant super alloy
TT5100 CVD coated	P20 – P35 M20 – M35	<ul style="list-style-type: none"> Medium grooving and turning of mild steel, low carbon steel and low carbon alloy steel Low to medium speed machining of stainless steel
TT9080 PVD coated	P20 – P40 M20 – M40 S20 – S40	<ul style="list-style-type: none"> General machining of steel, stainless steel and heat-resistant super alloy for parting, grooving and turning Continuous cut and medium cutting speed
TT4430 PVD coated	P20 – P40 M20 – M40 S20 – S40	<ul style="list-style-type: none"> General machining of steel, stainless steel and heat-resistant super alloy for small parts Grooving, turning and parting
TT7220 PVD coated	P25 – P45 M25 – M45	<ul style="list-style-type: none"> Rough machining of steel and stainless steel for parting, grooving and turning
TT8020 PVD coated	P30 – P50 M30 – M50 S30 – S50	<ul style="list-style-type: none"> Low speed or rough and interrupted machining of steel, stainless steel and heat-resistant super alloy for parting, grooving and turning
CT3000 Cermet	P10 – P20 M10 – M20 K10 – K20	<ul style="list-style-type: none"> Good surface finish turning of steel, stainless steel and cast iron
K10 Carbide	K05 – K15 N05 – N15 S05 – S15	<ul style="list-style-type: none"> General machining of cast iron, aluminum alloys, non-ferrous materials and titanium alloys
TB2015 CBN	H10 – H20	<ul style="list-style-type: none"> Continuous and light interrupted machining of hardened steel
KP300 PCD	N10 – N25	<ul style="list-style-type: none"> General machining of aluminum alloys

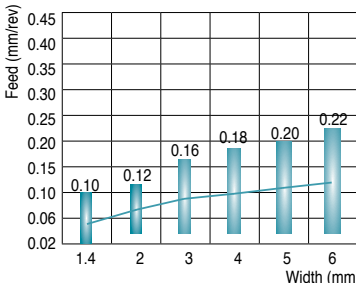

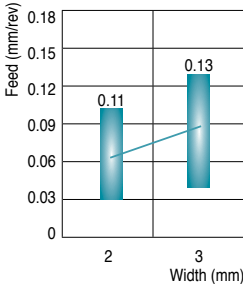
Chip Breakers

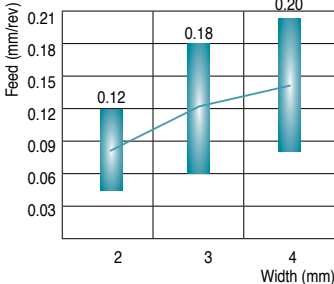
Parting and grooving

Chip breakers	Applications and features
<p>C-Type</p> 	 <ul style="list-style-type: none"> • 1st choice for general use in parting and deep grooving • Stable cutting edge & interrupted cut • Medium-to-high feed • For carbon steel, alloy steel and cast iron • For hard materials
<p>J-Type</p> 	 <ul style="list-style-type: none"> • 1st choice for soft materials in parting and deep grooving • Sharp cutting edge & low cutting force • Low-to-medium feed • Tubes, small diameter and thin-wall parts • For stainless steel & low carbon steel • For heat resistant super alloy
<p>UF-Type</p> 	 <ul style="list-style-type: none"> • Narrow chip breaker • Good chip control in low feed of ductile materials and low carbon steel • For Cr-Ni alloy steel and bearing steel
<p>V-Type</p> 	 <ul style="list-style-type: none"> • Sharp cutting edge and wide groove with minimized burrs • For tubes of small size workpieces • For stainless steel and mild steel

Chip Breakers

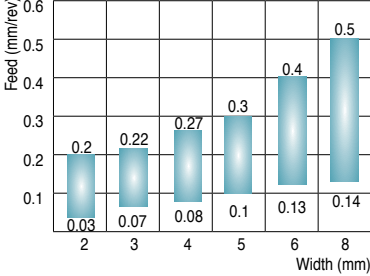
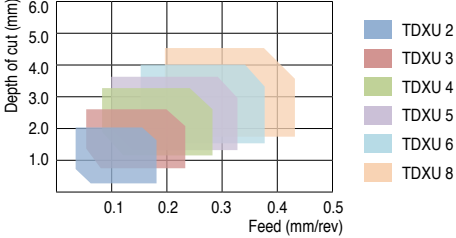
Groove-Turn

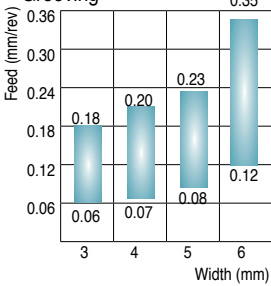
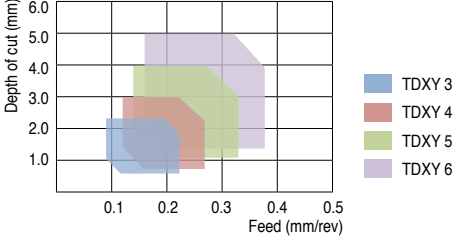
Chip breakers	Applications and features
<p>XU-Type</p> 	<p>■ Grooving</p>  <p>■ Turning</p>  <ul style="list-style-type: none"> • 1st choice for general use in groove-turn • Multi functional chip breaker for external, internal and face machining • Low cutting force and good chip control • Medium-to-high feed grooving, low-to-medium feed turning • Steel, stainless steel and heat resistant alloy
<p>XY-Type</p> 	<p>■ Grooving</p>  <p>■ Turning</p>  <ul style="list-style-type: none"> • For external and internal grooving as well as turning applications • Good chip control when external face grooving and turning • Flat bottom surface machining • Low-to-medium feed grooving, medium-to-high feed turning • Ideal for steel, stainless steel, cast iron and super alloys machining

Chip Breakers

Groove-Turn

Chip breakers Applications and features

T-Type

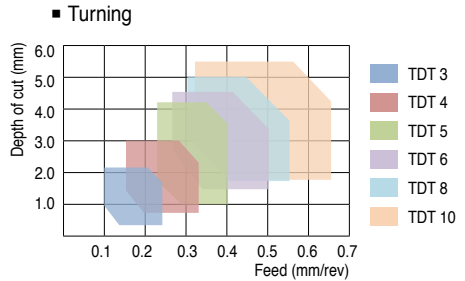
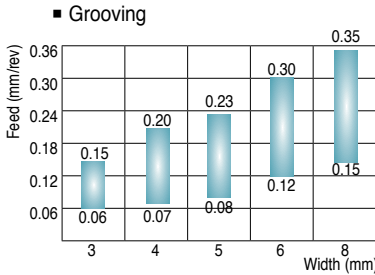

- 1st choice for side turning of cast iron
- Turning and grooving with various geometry
- Steel and cast iron
- High feed rate

RS-Type

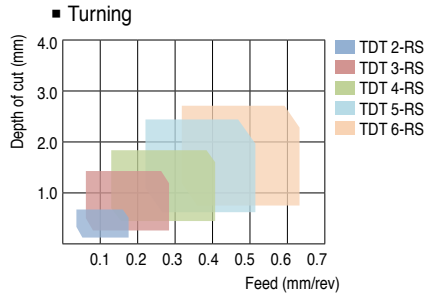
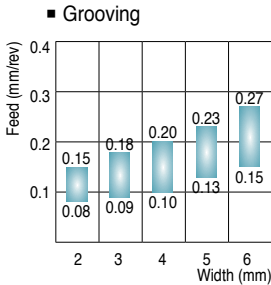

- 1st choice for medium to finishing machining of heat-resistant super alloys
- For external and internal profiling, turning and grooving applications
- Low cutting force and good surface finish due to the sharp edge
- Precision machining and excellent repeatability

RU-Type

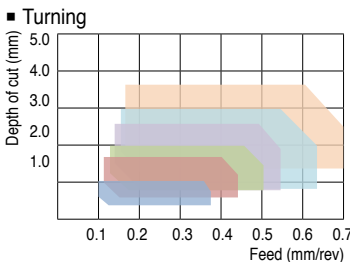

- Profiling in steel and cast iron
- Tough cutting edge
- Good chip control even in low depth
- Good surface finish
- High feed rate and low depth of cut

Parting & Grooving Toolholders



SFER/L-TB

Holders for parting and deep grooving with high pressure coolant

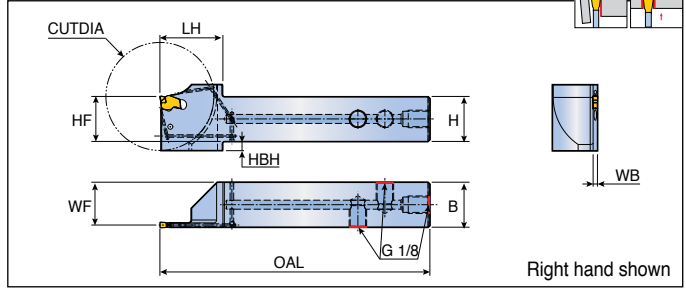

Designation	Insert seat size	Dimension (mm)										Insert
		H	HF	B	OAL	LH	WF	WB	HBH	CUTDIA		
SFER/L 2525-2T25-D50-TB	2	25	25	25	150	32	24.1	1.8	-	50	SFC	
2525-3T30-D60-TB	3	25	25	25	150	35	23.8	2.4	5	60	SFJ	
											B112	

• Please refer to B106 page for COOL-BURST accessories

Spare parts

Designation	Plug	Wrench	Extractor	
SFER/L-TB	PLG G1/8-L6.5	L-W 5	ETG 3-4	

• Extractor should be ordered separately

Triangular blades for parting and deep grooving

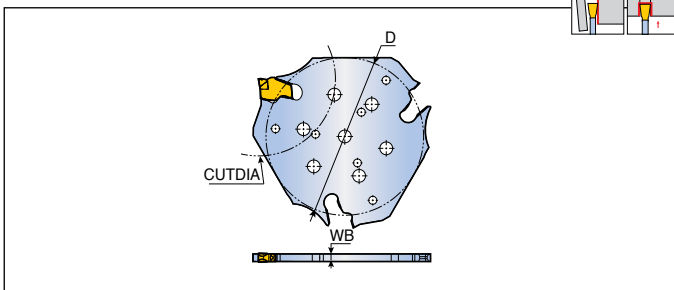

Designation	Insert seat size	Dimension (mm)			Block	Insert
		D	WB	CUTDIA		
SFTB D52-2	2	53.2	1.8	52	THTBR/L-TB B35	SFC SFJ B112
D52-3	3	53.2	2.5	52		
D82-2	2	64.3	1.8	82	THTBR/L-TB B35	SFC SFJ B112
D82-3	3	64.3	2.5	82		
D120-2	2	85.5	1.8	120	THTBR/L-TB B35	SFC SFJ B112
D120-3	3	85.5	2.5	120		

SFTB-TB

Triangular blades for parting and deep grooving with high pressure coolant

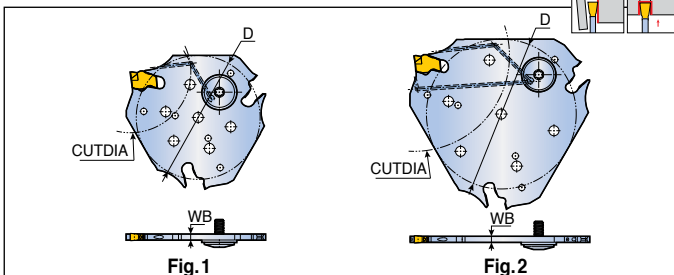

Designation	Insert seat size	Dimension (mm)			Fig.	Block	Insert
		D	WB	CUTDIA			
SFTB D52-2-TB	2	53.2	1.8	52	1	THTBR/L-TB B35	SFC SFJ B112
D52-3-TB	3	53.2	2.5	52	1		
D82-2-TB	2	64.3	1.8	82	2	THTBR/L-TB B35	SFC SFJ B112
D82-3-TB	3	64.3	2.5	82	2		
D120-2-TB	2	85.5	1.8	120	2	THTBR/L-TB B35	SFC SFJ B112
D120-3-TB	3	85.5	2.5	120	2		

Spare parts

Designation	Sealing screw set	Extractor		
	SFTB	-	ETG 3-4	
SFTB-TB	SGC 340-Q	ETG 3-4		

• Extractor should be ordered separately

THTBR/L-TB

Blocks for triangular blade

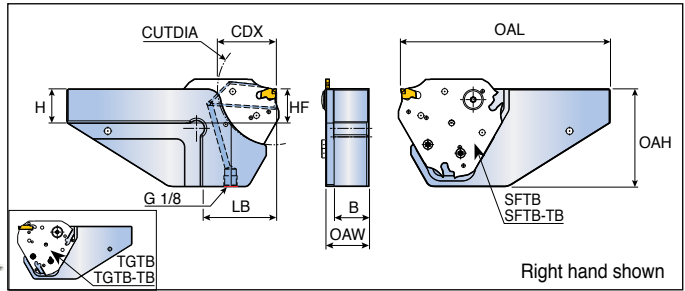

Designation	Dimension (mm)								Blade
	H	HF	B	OAL	OAH	OAW	LB	CUTDIA	
THTBR/L 20-D52-TB	20	20	17.5	125	52	23.5	40	52	SFTB/SFTB-TB TGTB/TGTB-TB B34, B38
25-D52-TB	25	25	22.5	135	52	28.5	40	52	
20-D82-TB	20	20	17.5	140	72	23.5	51.5	82	
25-D82-TB	25	25	22.5	150	72	28.5	51.5	82	
25-D120-TB	25	25	22.5	165	95	28.5	67	120	
32-D120-TB	32	32	29.0	165	95	35.0	67	120	

• Please refer to B106 page for COOL-BURST accessories

Table determining depth of cut for grooving as function of workpiece diameter

Designation	CUTDIA											
	CDX	5	6	7	8	9	10	11	12	13	14	15
SFTB/TGTB D52	240	164	137	118	105	94	86	80	74	70	66	
D82	N.L.	N.L.	3686	1126	734	524	408	335	284	247	219	
SFTB D120	N.L.	N.L.	7752	2581	1548	1105	860	704	597	518	458	

• N.L.: No limit

Designation	CUTDIA											
	CDX	16	17	18	19	20	21	22	23	24	25	26
SFTB/TGTB D52	64	61	59	57	56	55	54	53	52	52	52	
D82	197	180	166	154	144	135	128	122	116	112	108	
SFTB D120	411	373	342	316	294	276	259	245	233	222	212	

Designation	CUTDIA															
	CDX	27	28	29	30	31	32	33	34	35	36	37	38	39	40	41
SFTB/TGTB D82	104	101	98	96	93	91	90	88	87	86	85	84	83	82	82	
SFTB D120	203	195	188	182	176	171	166	162	158	154	151	148	145	143	140	

Designation	CUTDIA														
	CDX	42	43	44	45	46	47	48	49	51	52	55	54-53	57-56	58-60
SFTB D120	136	134	133	131	130	128	127	126	125	124	122	123	121	120	

Spare parts

Designation	Locating pin	Screw	O-Ring	Wrench
	THTBR/L-TB	SIDE THRUST PIN 3MM	SH M4X0.7X10-TX	O-RING ID10X2

Blades for parting and deep grooving

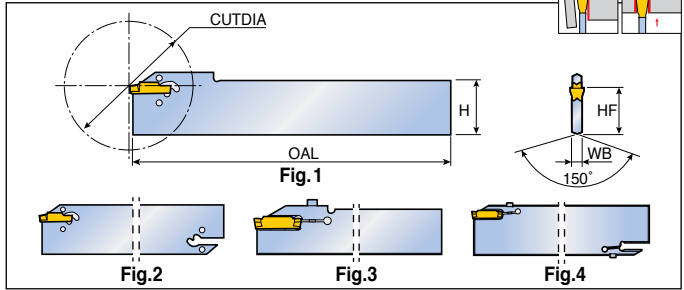

Designation	Insert seat size	Dimension (mm)					Fig.	Block	Insert
		H	HF	OAL	WB	CUTDIA			
TGB 26-1.4S⁽¹⁾	1 *	26	21.4	150	1.0 ⁽²⁾	26	1	TTBN/U...26	TDC / J / T TDXU / XT / XY TSC / J TDUF/TDV B113-B121
26-2S⁽¹⁾	2	26	21.4	150	1.8 ⁽²⁾	40	1	TTBN/U...26	
26-3S⁽¹⁾	3	26	21.4	150	2.4	50	1	TTBN/U...26	
26-4S⁽¹⁾	4	26	21.4	150	3.2	80	1	TTBN/U...26	
32-1.4	1 *	32	24.9	150	1.0 ⁽²⁾	26	2	TTBN/U...32	
32-2	2	32	24.9	150	1.8 ⁽²⁾	50	2	TTBN/U...32	
32-3	3	32	24.9	150	2.4	100	2	TTBN/U...32	
32-4	4	32	24.9	150	3.2	100	2	TTBN/U...32	
32-5	5	32	24.9	150	4.0	120	2	TTBN/U...32	
32-6	6	32	24.9	150	5.2	120	2	TTBN/U...32	
45-4	4	45	38.1	150	3.2	120	2	TTBN/U...45	
32-8S-CL⁽¹⁾	8	32	24.9	150	6.2	80	3	TTBN/U...32	
52-8-CL	8	52	45.2	250	7.4	200	4	TTBN/U...52 B44-B45	

- ⁽¹⁾ Single ended blade
- ⁽²⁾ Thickness at DOC area only. Overall thickness is 2.4mm
- * TDJ 1.4 insert only

Spare parts

Designation	Extractor	Screw	Wrench	
TGB 26-1.4S / 32-1.4	EDG 23B	-	-	
TGB 26 / 32 / 45	EDG 33B	-	-	
TGB 32-8S-CL	-	SH M4x0.7x20-MO	L-W 3	
TGB 52-8-CL	-	SH M4x0.7x20-MO	L-W 3	

• Extractor should be ordered separately

Triangular blades for parting and deep grooving

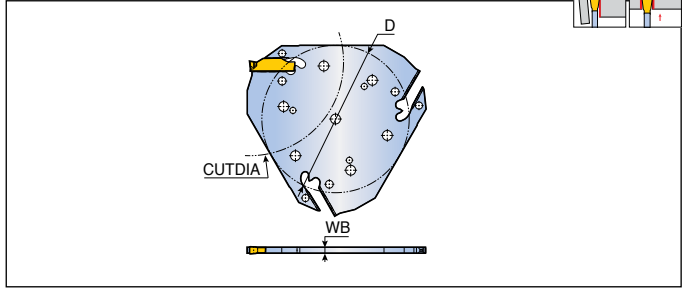
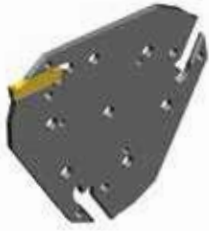

Designation	Insert seat size	Dimension (mm)			Block	Insert
		D	WB	CUTDIA		
TGTB D52-2	2	53.2	1.8	52	THTBR/L-TB	TDC / J / T
D52-3	3	53.2	2.5	52	B35	TDXU / XT / XY
D82-2	2	64.3	1.8	82		TSC / J / TDUF / TDV
D82-3	3	64.3	2.5	82		B113-B121

TGTB-TB

Triangular blades for parting and deep grooving with high pressure coolant

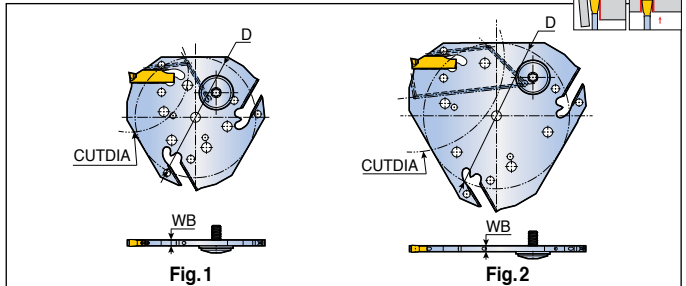

Designation	Insert seat size	Dimension (mm)			Fig.	Block	Insert
		D	WB	CUTDIA			
TGTB D52-2-TB	2	53.2	1.8	52	1	THTBR/L-TB	TDC / J / T
D52-3-TB	3	53.2	2.5	52	1	B35	TDXU / XT / XY
D82-2-TB	2	64.3	1.8	82	2		TSC / J / TDUF / TDV
D82-3-TB	3	64.3	2.5	82	2		B113-B121

Spare parts

Designation	Sealing screw set	Extractor		
TGTB	-	EDG 33B		
TGTB-TB	SGC 340-Q	EDG 33B		

• Extractor should be ordered separately

TGBR/L -D..R/L

Reinforced blades for parting and deep grooving with screw clamping

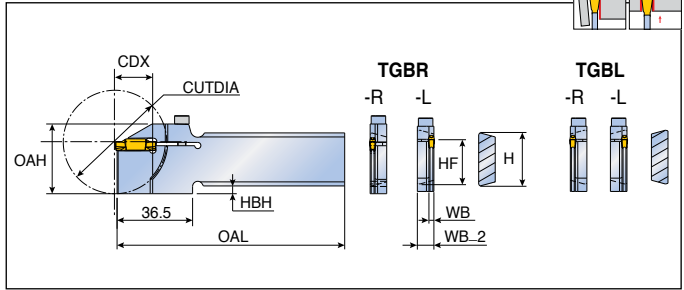

Designation	Insert seat size	Dimension (mm)									Block	Insert
		H	HF	OAL	OAH	WB	WB_2	HBH	CDX	CUTDIA		
TGBR 26-2-D50R ⁽¹⁾	2	26	21.4	110	33.7	1.8	8	3.6	18	50	TTBN/U...26	TDC / J / T
26-2-D50L ⁽²⁾	2	26	21.4	110	33.7	1.8	8	3.6	18	50	TTBN/U...26	TDXU / XT / XY
TGBL 26-2-D50R ⁽²⁾	2	26	21.4	110	33.7	1.8	8	3.6	18	50	TTBN/U...26	TSC / J
26-2-D50L ⁽¹⁾	2	26	21.4	110	33.7	1.8	8	3.6	18	50	TTBN/U...26	TDUF / TDV
TGBR 26-3-D50R ⁽¹⁾	3	26	21.4	110	33.7	2.4	8	3.6	18	50	TTBN/U...26	B113-B121
26-3-D50L ⁽²⁾	3	26	21.4	110	33.7	2.4	8	3.6	18	50	TTBN/U...26	
TGBL 26-3-D50R ⁽²⁾	3	26	21.4	110	33.7	2.4	8	3.6	18	50	TTBN/U...26	
26-3-D50L ⁽¹⁾	3	26	21.4	110	33.7	2.4	8	3.6	18	50	TTBN/U...26	
TGBR 32-2-D50R ⁽³⁾	2	32	24.9	120	33.7	1.8	8	-	18	50	TTBN/U...32	
32-2-D50L ⁽²⁾	2	32	24.9	120	33.7	1.8	8	-	18	50	TTBN/U...32	
TGBL 32-2-D50R ⁽²⁾	2	32	24.9	120	33.7	1.8	8	-	18	50	TTBN/U...32	
32-2-D50L ⁽³⁾	2	32	24.9	120	33.7	1.8	8	-	18	50	TTBN/U...32	
TGBR 32-3-D50R ⁽³⁾	3	32	24.9	120	33.7	2.4	8	-	18	50	TTBN/U...32	
32-3-D50L ⁽²⁾	3	32	24.9	120	33.7	2.4	8	-	18	50	TTBN/U...32	
TGBL 32-3-D50R ⁽²⁾	3	32	24.9	120	33.7	2.4	8	-	18	50	TTBN/U...32	
32-3-D50L ⁽³⁾	3	32	24.9	120	33.7	2.4	8	-	18	50	TTBN/U...32	B44-B45

- ⁽¹⁾ for Traub machines, model TNC 30, TNM 28, TNS 26/30/42/112, TNA 300, TNK 260
- ⁽²⁾ for Tornos Bechler, model Emco 2000/20, 2000/26
- ⁽³⁾ for Traub machines, model TNC 42/65, TNM 42/65, TNS 42/60/65, TNA 300/400

Spare parts

Designation	Screw	Wrench		
	TGBR/L -DR/L	SH M4x0.7x16	L-W 3	

Blades for face grooving

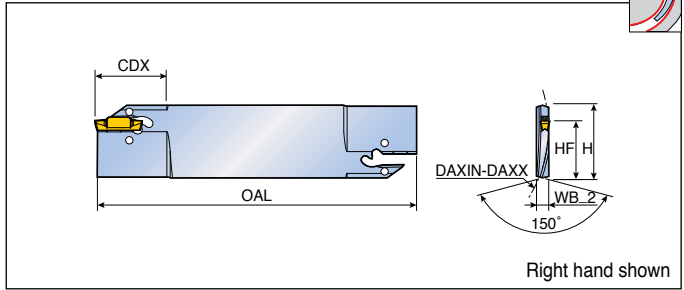

Designation	Insert seat size	Dimension (mm)								Block	Insert	
		H	HF	OAL	WB_2	CDX	DAXIN	DAXX				
TGBFR/L 32T 20-40-60-3	3	32	24.9	150	5.2	20	40	60	TTBN/U...32 B44-B45	TDC / J / T TDXU / XT / XY TDFT TSC / J TDUF / TDV B113-B121		
32T 20-54-80-3	3	32	24.9	150	5.2	20	54	80				
32T25-74-120-3	3	32	24.9	150	5.2	25	74	120				
32T25-114-180-3	3	32	24.9	150	5.2	25	114	180				
32T25-40-60-4	4	32	24.9	150	5.2	25	40	60				
32T25-50-80-4	4	32	24.9	150	5.2	25	50	80				
32T30-70-130-4	4	32	24.9	150	5.2	30	70	130				
32T30-120-200-4	4	32	24.9	150	5.2	30	120	200				
32T30-200-4	4	32	24.9	150	5.2	30	200	∞				
32T32-60-95-5	5	32	24.9	150	5.2	32	60	95				
32T35-85-140-5	5	32	24.9	150	5.2	35	85	140				
32T35-130-250-5	5	32	24.9	150	5.2	35	130	250				
32T35-250-5	5	32	24.9	150	5.2	35	250	∞				
32T32-80-180-6	6	32	24.9	150	5.2	32	80	180				
32T38-168-300-6	6	32	24.9	150	5.2	38	168	300				
32T38-300-6	6	32	24.9	150	5.2	38	300	∞				

• Please check insert min. dia for face grooving B74 page

Spare parts

Designation	Extractor			
TGBFR/L	EDG 33B			

• Extractor should be ordered separately

Holders for parting and deep grooving

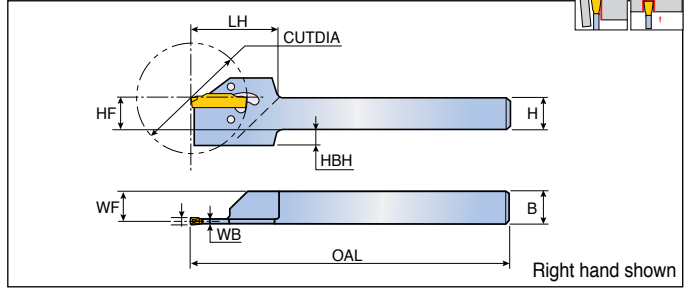

Designation	Insert seat size	Dimension (mm)								CUTDIA		Insert
		H	HF	B	OAL	LH	WF	WB	HBH	TDJ/C	TSJ/C	
TGER/L 2020-1.4T10	1 *	20	20	20	125	31	19.5	1.0	-	20	20	TDC / J / T
1010-2	2	10	10	10	150	31	9.1	1.8	8	33	33	TDXU / XT / XY
1212-2	2	12	12	12	150	31	11.1	1.8	6	35	35	TSC / J
1616-2	2	16	16	16	150	31	15.1	1.8	2	35	35	TDUF / TDV
2012-2	2	20	20	12	150	31	11.1	1.8	-	35	35	B113-B121
2020-2	2	20	20	20	125	31	19.1	1.8	-	35	35	
1212-3	3	12	12	12	150	31	10.8	2.4	6	38	40	
1616-3	3	16	16	16	150	31	14.8	2.4	2	38	45	
2020-3	3	20	20	20	125	31	18.8	2.4	-	38	45	
2525-3	3	25	25	25	150	31	23.8	2.4	-	38	45	
2020-4	4	20	20	20	125	33	18.4	3.2	-	38	55	
2525-4	4	25	25	25	150	33	23.4	3.2	-	38	55	

* TDJ 1.4 insert only

Spare parts

Designation	Extractor			
TGER/L.....-1.4T10	EDG 23B			
TGER/L.....-2	EDG 33B			
TGER/L.....-3	EDG 33B			
TGER/L.....-4	EDG 33B			

• Extractor should be ordered separately

Blocks for blades

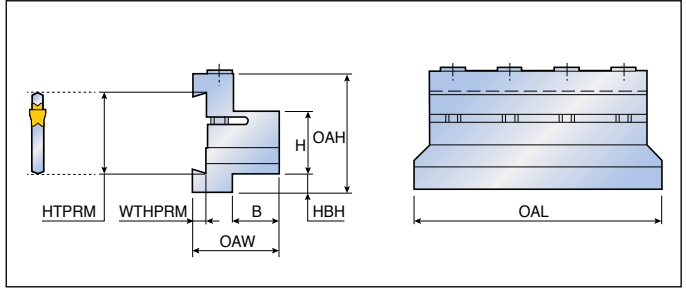

Designation	Dimension (mm)							
	HTPRM	H	HBH	OAH	WTHPRM	OAL	B	OAW
TTBN 16-26	26	16	12	38	4.0	87	15	29
20-26	26	20	8	38	4.0	87	19	33
25-26	26	25	3	38	4.0	110	20	34
20-32	32	20	13	48	5.5	100	19	35
25-32	32	25	8	48	5.5	110	20	36
32-32	32	32	3	48	5.5	120	28	44
25-45	45	25	25	66	5.5	110	22	40
32-45	45	32	18	66	5.5	120	28	45
40-52	52	40	21	82	8.0	160	40	65

Spare parts

Designation	Screw	Wrench		
TTBN...26	SH M6x1x25	L-W 5		
TTBN...32	SH M6x1x30	L-W 5		
TTBN...45	SH M6x1x40	L-W 5		
TTBN...52	SH M8x1.25x45	L-W 6		



TTBU-TB

Blocks for blades with high pressure coolant



COOLBURST

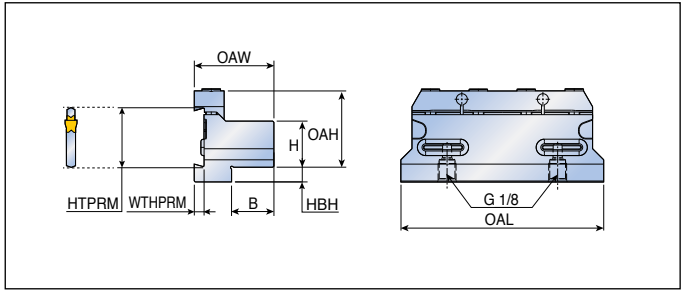

Designation	Dimension (mm)							
	HTPRM	H	HBH	OAH	WTHPRM	OAL	B	OAW
TTBU 20-32-TB	32	20	15	36.4	5.3	100	19	39.2
25-32-TB	32	25	8	41.4	5.3	110	23	43.2
32-32-TB	32	32	5	48.4	5.3	110	29	49.2

Spare parts

Designation	Screw	Clamp	O-ring	Wrench
TTBU 20-32-TB	SR M6X16 DIN912	BKU 100	O-RING ID14X2.5	L-W 5
TTBU 25-32-TB	SR M6X16 DIN912	BKU 110	O-RING ID14X2.5	L-W 5
TTBU 32-32-TB	SR M6X16 DIN912	BKU 110	O-RING ID14X2.5	L-W 5



Cartridges for external grooving

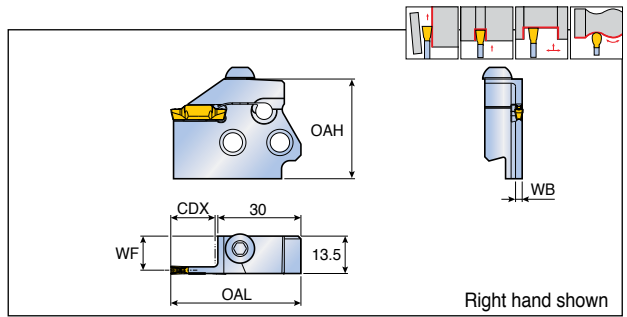

Designation	Insert seat size	Dimension (mm)					Holder	Insert
		OAL	WF	WB	OAH	CDX		
TCAER/L 1.4T12	1*	47	13.0	1.0	36	12	TCAHR/L	TDJ 1.4
2T16	2	47	12.6	1.8	36	16	TCAHPL/R	TDC / J / T
2T22	2	53	12.6	1.8	36	22	C...TCAHN	TDXU / XT / XY
3T16	3	47	12.3	2.4	36	16	C...TCAHPN	TSC / J
3T22	3	53	12.3	2.4	36	22	B52-B55	TDUF / TDV
4T16	4	47	12.0	3.0	36	16		B113-B121
4T22	4	53	12.0	3.0	36	22		
5T20	5	51.5	11.6	3.9	36	20		
5T25	5	56	11.6	3.9	36	25		
6T20	6	51.5	11.1	4.9	36	20		
6T25	6	56	11.1	4.9	36	25		

• * TDJ 1.4 insert only

Spare parts

Designation	Screw	Wrench		
	TCAER/L	BH M6x1x16	L-W 4	

Cartridges for external face grooving

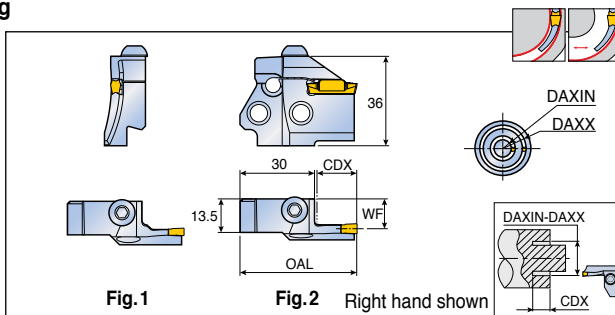

Designation	Insert seat size	Dimension (mm)					Fig.	Holder	Insert
		OAL	WF	CDX	DAXIN	DAXX			
TCAFR/L									
3T10-29-40 RN	3	40	12.4	10	29	40	1	TCAHL/R	TDC / J / T
3T12-40-55 RN	3	47	12.4	12	40	55	1	TCAHPR/L	TDXU / XT / XY
3T12-55-75 RN	3	47	12.4	12	55	75	1	C..TCAHN	TDFT
3T12-75-100 RN	3	47	12.4	12	75	100	1	C..TCAHPN	TSC / J
3T12-100-140 RN	3	47	12.4	12	100	140	1	B52-B55	TDUF / TDV
3T12-140-200 RN	3	47	12.4	12	140	200	1		B113-B121, B123
4T16-34-50 RN	4	47	12.0	16	34	50	2		
4T16-50-70 RN	4	47	12.0	16	50	70	2		
4T16-70-100 RN	4	47	12.0	16	70	100	2		
4T16-100-150 RN	4	47	12.0	16	100	150	2		
4T16-150-250 RN	4	47	12.0	16	150	250	2		
4T16-250 RN	4	47	12.0	16	250	∞	2		
5T20-55-80 RN	5	51.5	11.5	20	55	80	2		
5T20-80-120 RN	5	51.5	11.5	20	80	120	2		
5T20-120-180 RN	5	51.5	11.5	20	120	180	2		
5T20-180-300 RN	5	51.5	11.5	20	180	300	2		
5T20-300 RN	5	51.5	11.5	20	300	∞	2		
6T25-60-90 RN	6	56	11.0	25	60	90	2		
6T25-90-150 RN	6	56	11.0	25	90	150	2		
6T25-150-250 RN	6	56	11.0	25	150	250	2		
6T25-250-400 RN	6	56	11.0	25	250	400	2		
6T25-400 RN	6	56	11.0	25	400	∞	2		

• Please check insert min. dia for face grooving B74 page

Spare parts

Designation	Screw	Wrench		
TCAFR/L	BH M6x1x16	L-W 4		

TCAQR/L 20



Cartridges for external grooving

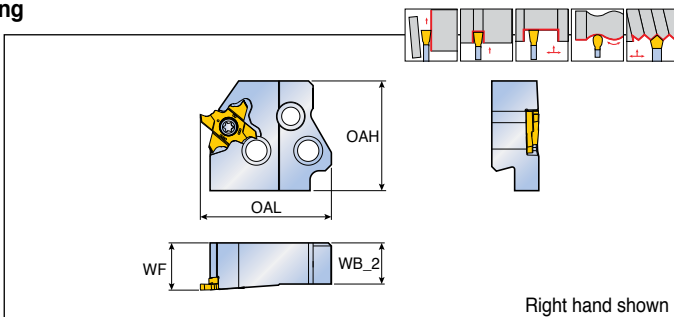

Right hand shown

Designation	Dimension (mm)				Holder	Insert
	OAL	WF	WB_2	OAH		
TCAQR/L 20	43	15.5	13.5	36	TCAHR/L, TCAHPL/R C...TCAHN, C...TCAHPN B52-B55	TQ...20 B147-B148

TCAQR/L 27/34



Cartridges for external grooving

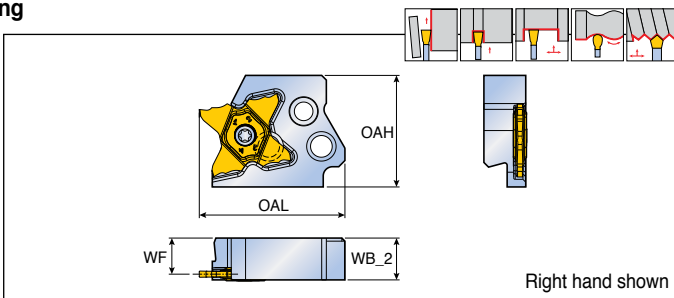

Right hand shown

Designation	Dimension (mm)				Holder	Insert
	OAL	WF	WB_2	OAH		
TCAQR/L 27	47	12.3	13.5	36	TCAHR/L, TCAHPL/R C...TCAHN, C...TCAHPN B52-B55	TQ... 27
34	47	11.7	13.5	36		TQ... 34 B149-B159

Spare parts

Designation	Screw	Wrench	Designation	Screw	Wrench
TCAQR 20	TS 40A100L	T-1508/5	TCAQR 27/34	TS 50125IL	T 10/20
TCAQL 20	TS 40A100	T-1508/5	TCAQL 27/34	TS 50125I	T 10/20

TCAQR/L 20-TB



Cartridges for external grooving with high pressure coolant



COOLBURST

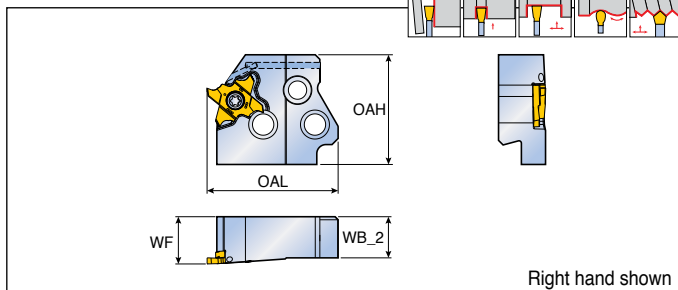

Designation	Dimension (mm)				Holder	Insert
	OAL	WF	WB_2	OAH		
TCAQR/L 20-TB	43	15.5	13.5	36	TCAHR/L-TB, TCAHPL/R-TB C...TCAHN-TB, C...TCAHPN-TB B52-B55	TQ...20 B147-B148

TCAQR/L 27-TB



Cartridges for external grooving with high pressure coolant



COOLBURST

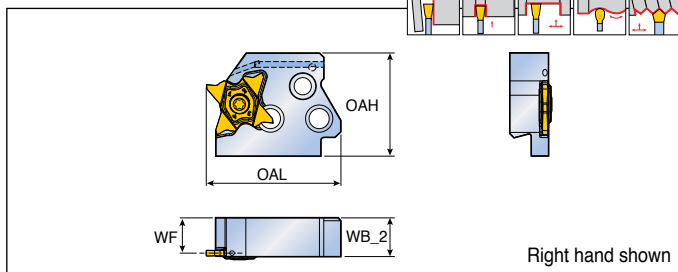

Designation	Dimension (mm)				Holder	Insert
	OAL	WF	WB_2	OAH		
TCAQR/L 27-TB	47	12.3	13.5	36	TCAHR/L-TB, TCAHPL/R-TB C...TCAHN-TB, C...TCAHPN-TB B52-B55	TQ...27 B149-B157

Spare parts

Designation	Screw	Wrench	Designation	Screw	Wrench
TCAQR 20-TB	TS 40A100L	T-1508/5	TCAQR 27-TB	TS 50125IL	T 10/20
TCAQL 20-TB	TS 40A100	T-1508/5	TCAQL 27-TB	TS 50125I	T 10/20

Parallel type holders for cartridge

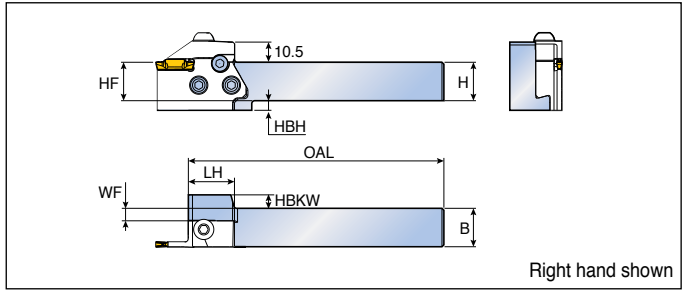

Designation	Dimension (mm)								Cartridge
	H	HF	B	OAL	WF	HBH	HBKW	LH	
TCAHR/L 2020	20	20	20	133	6.5	5	7	24	TCAER/L, TCAFL/R TCAQR/L B47, B49, B50
2525	25	25	25	133	11.5	-	2	24	
3232	32	32	32	153	18.5	-	-	24	

• Cartridge should be ordered separately

TCAHR/L-TB

Parallel type holders for cartridge with high pressure coolant

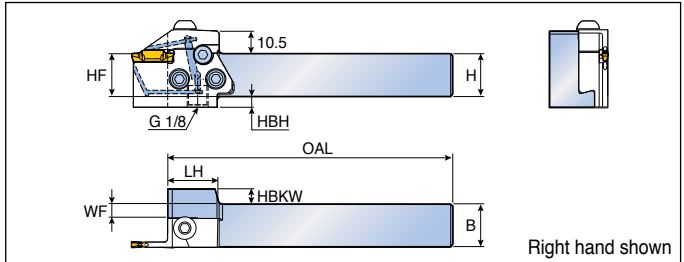

Designation	Dimension (mm)								Cartridge
	H	HF	B	OAL	WF	HBH	HBKW	LH	
TCAHR/L 2020-TB	20	20	20	133	6.5	5	7	24	TCAER/L-TB TCAQR/L-TB B48, B51
2525-TB	25	25	25	133	11.5	-	2	24	

- Cartridge should be ordered separately
- Please refer to B106 page for COOL-BURST accessories

Spare parts

Designation	Screw	Security Screw	Sealing Screw	O-Ring	Wrench	
TCAHR/L	TS 60190I	SH M5X0.8X16	-	-	L-W 4	-
TCAHR/L-TB	TS 60190I	SH M5X0.8X16	SS M4X0.7X4-NL	O-RING ID5X1T	L-W 4	L-W 2

TCAHPR/L

Perpendicular type holders for cartridge

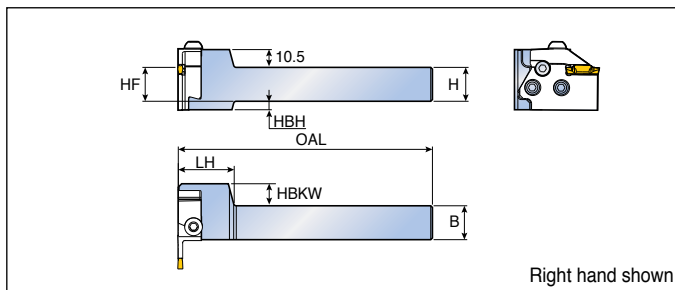

Designation	Dimension (mm)							Cartridge
	H	HF	B	OAL	HBH	HBKW	LH	
TCAHPR/L 2020	20	20	20	150	5	13	33	TCAEL/R, TCAFR/L TCAQL/R B47, B49, B50
2525	25	25	25	150	-	8	33	
3232	32	32	32	170	-	1	33	

• Cartridge should be ordered separately

TCAHPR/L-TB

Perpendicular type holders for cartridge with high pressure coolant

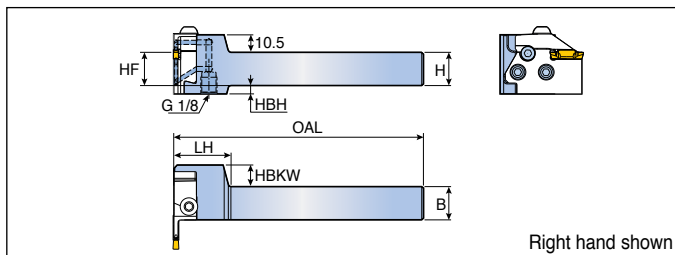

Designation	Dimension (mm)							Cartridge
	H	HF	B	OAL	HBH	HBKW	LH	
TCAHPR/L 2020-TB	20	20	20	150	5	13	33	TCAEL/R-TB TCAQL/R-TB B48, B51
2525-TB	25	25	25	150	-	8	33	

- Cartridge should be ordered separately
- Please refer to B106 page for COOL-BURST accessories

Spare parts

Designation	Screw	Security Screw	Sealing Screw	O-Ring	Wrench	
TCAHPR/L	TS 60190I	SH M5X0.8X16	-	-	L-W 4	-
TCAHPR/L-TB	TS 60190I	SH M5X0.8X16	SS M4X0.7X4-NL	O-RING ID5X1T	L-W 4	L-W 2

C-TCAHN

Parallel type C-Adapters

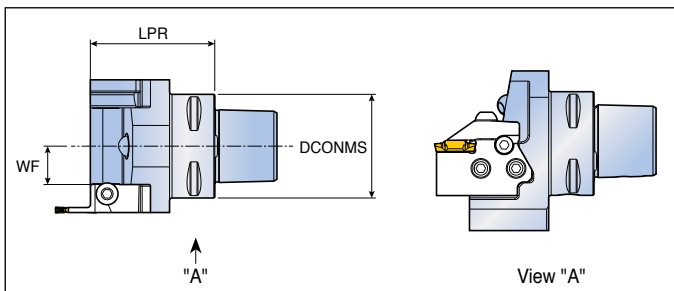

Designation	Dimension (mm)			Cartridge
	DCONMS	LPR	WF	
C4-TCAHN	40	60	18.7	TCAER/L, TCAFR/L
C5-TCAHN	50	60	18.5	TCAQR/L
C6-TCAHN	63	60	19	TCAER/L, TCAFR/L, TCAQR/L B47, B49, B50

• Cartridge should be ordered separately

C-TCAHN-TB

Parallel type C-Adapters with high pressure coolant

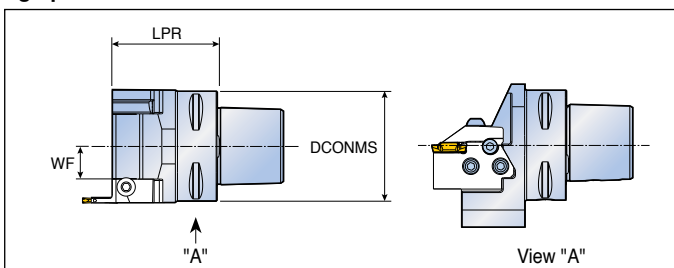

Designation	Dimension (mm)			Cartridge
	DCONMS	LPR	WF	
C4-TCAHN-TB	40	55	11.5	TCAER/L-TB
C5-TCAHN-TB	50	58	13.7	TCAQR/L-TB
C6-TCAHN-TB	63	60	18.7	TCAER/L-TB, TCAQR/L-TB B48, B51

• Cartridge should be ordered separately

Spare parts

Designation	Screw	Security Screw	Sealing Screw	Nozzle	O-Ring	Wrench
C-TCAHN	TS 60190I	SH M5X0.8X16	-	NZ 125	-	L-W 4
C-TCAHN-TB	TS 60190I	SH M5X0.8X16	SS M4X0.7X4-NL	-	O-RING ID5X1T	L-W 4 / L-W 2

C-TCAHPN

Perpendicular type C-Adapters

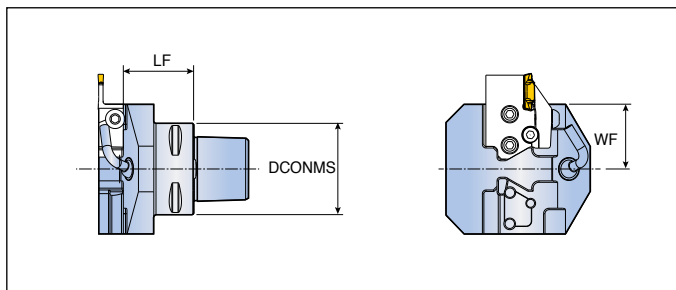

Designation	Dimension (mm)			Cartridge
	DCONMS	LF	WF	
C4-TCAHPN	40	40.5	34	TCAER/L, TCAFR/L
C5-TCAHPN	50	38.5	35.5	TCAQR/L
C6-TCAHPN	63	38.5	36	B47, B49, B51

• Cartridge should be ordered separately

C-TCAHPN-TB

Perpendicular type C-Adapters with high pressure coolant

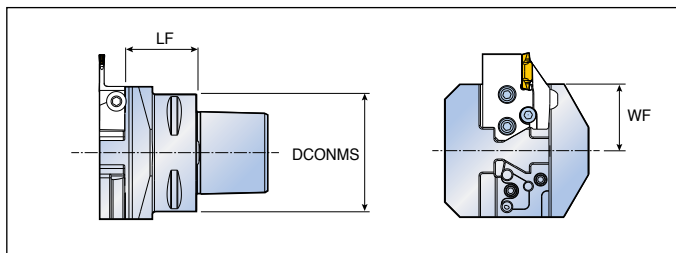

Designation	Dimension (mm)			Cartridge
	DCONMS	LF	WF	
C4-TCAHPN-TB	40	36.5	34	TCAER/L-TB
C5-TCAHPN-TB	50	36.5	35	TCAQR/L-TB
C6-TCAHPN-TB	63	38.5	35.5	B48, B51

• Cartridge should be ordered separately

Spare parts

Designation	Screw	Security Screw	Sealing Screw	Nozzle	O-Ring	Pipe	Wrench
C-TCAHPN	TS 60190I	SH M5X0.8X16	-	NZ 125	-	NZP 5	L-W 4
C-TCAHPN-TB	TS 60190I	SH M5X0.8X16	SS M4X0.7X4-NL	-	O-RING ID5X1T	-	L-W 4 / L-W 2

Cartridge and Holder Selection

Parallel type

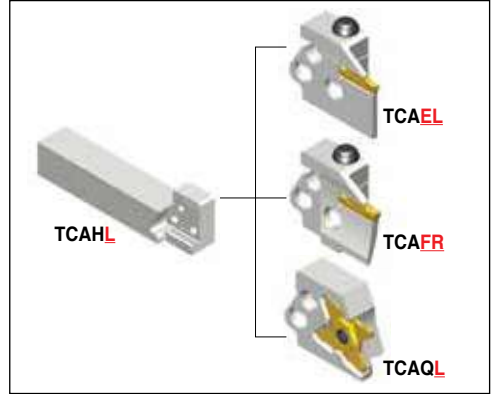
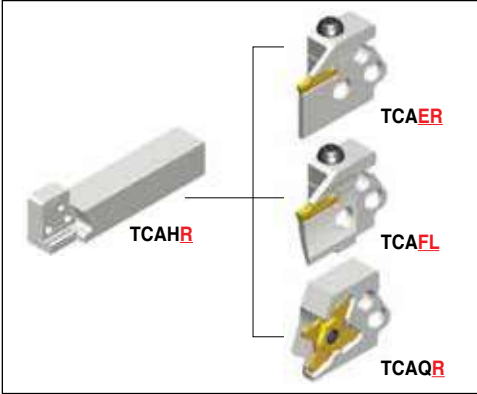

Perpendicular type

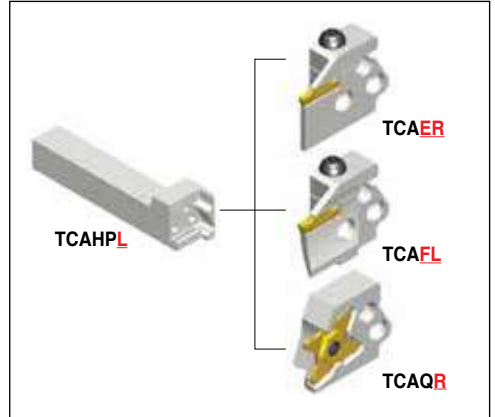
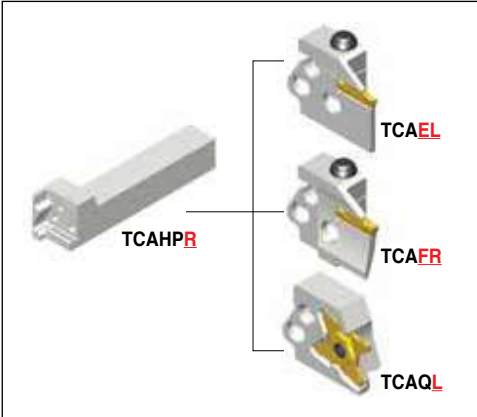

C-ADAPTER

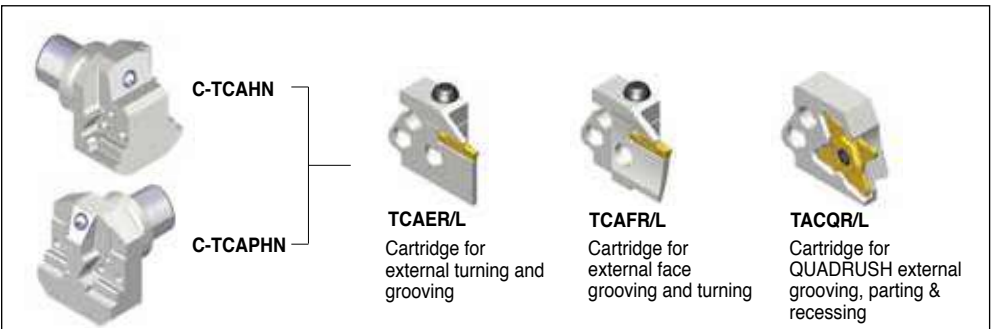

Cartridge and Holder Selection

Parallel type with high pressure coolant

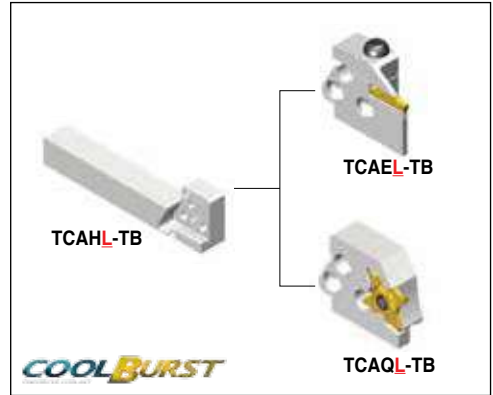
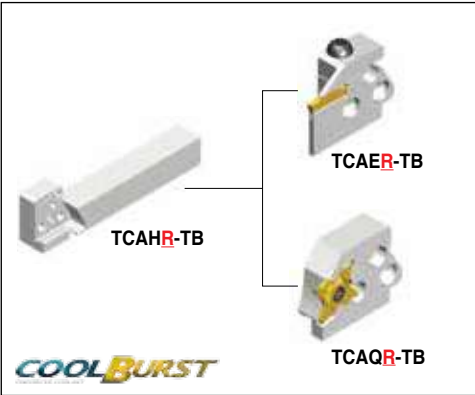

Perpendicular type with high pressure coolant

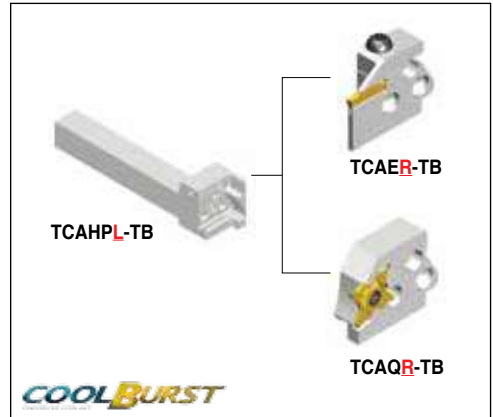
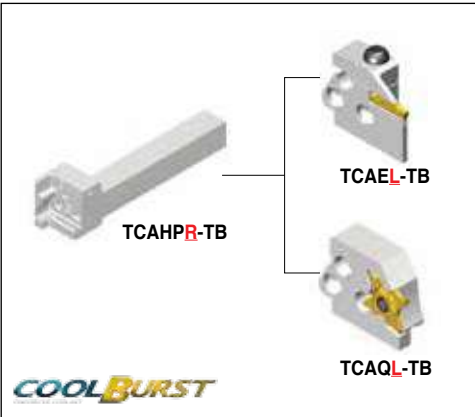

C-ADAPTER with high pressure coolant

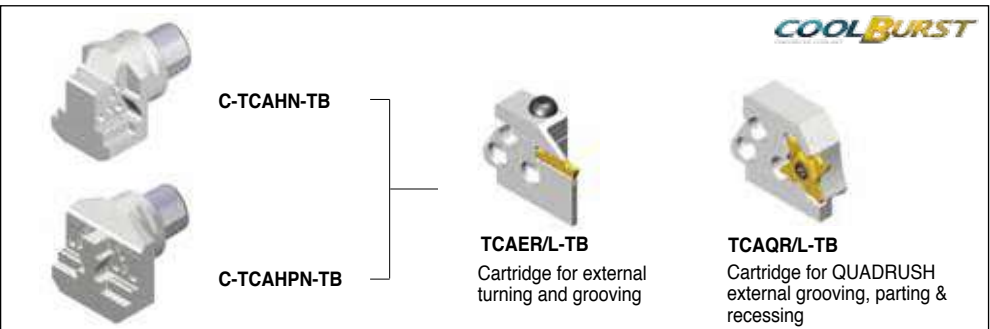

QE1 TTER

Modular heads for external turning and grooving

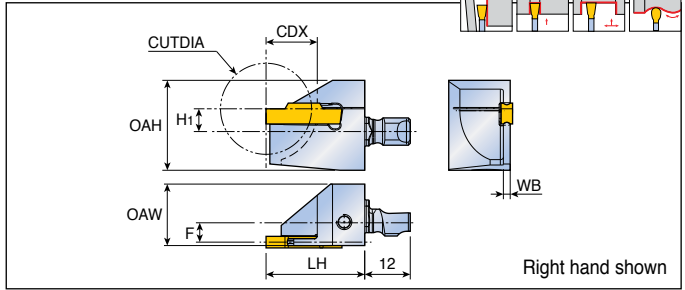

Designation	Insert seat size	Dimension (mm)								Shank	Insert
		OAH	LH	OAW	WB	CDX	CUTDIA	H ₁	F		
QE1 TTER 2-16-32	2	23.7	26.0	16.2	1.8	16.0	32.0	6.0	6.1	QE1 S12N-TB	TDC / J / T
2-12-24	2	23.7	26.0	16.2	1.8	12.0	24.0	6.0	6.1	QE1 S16R-TB	TDXU / XT / XY
3-16-32	3	23.7	26.0	16.2	2.4	16.0	32.0	6.0	5.8	B61, B62	TSC / J
3-12-24	3	23.7	26.0	16.2	2.4	12.0	24.0	6.0	5.8		TDUF / TDV
											B113-B121

QE1 TTEL

Modular heads for external turning and grooving

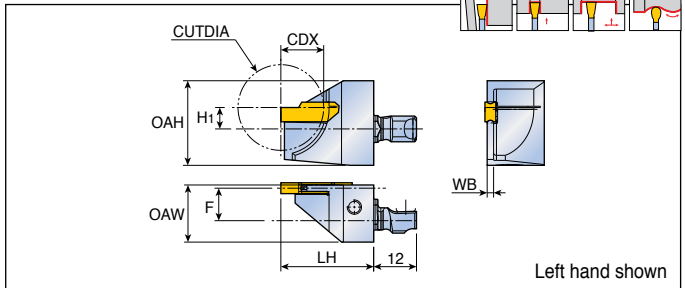

Designation	Insert seat size	Dimension (mm)								Shank	Insert
		OAH	LH	OAW	WB	CDX	CUTDIA	H ₁	F		
QE1 TTEL 2-16-32	2	23.7	26.0	16.0	1.8	16.0	32.0	6.0	8.1	QE1 S12N-TB	TDC / J / T
2-12-24	2	23.7	26.0	16.0	1.8	12.0	24.0	6.0	8.1	QE1 S16R-TB	TDXU / XT / XY
3-16-32	3	23.7	26.0	16.0	2.4	16.0	32.0	6.0	7.8	B61, B62	TSC / J
3-12-24	3	23.7	26.0	16.0	2.4	12.0	24.0	6.0	7.8		TDUF / TDV
											B113-B121

Spare parts

Designation	Screw	Wrench		
	QE1 TTER/L	SH M4X0.7X16	L-W 3	

QE1 TTER-TB

Modular heads for external turning and grooving with high pressure coolant



COOLBURST

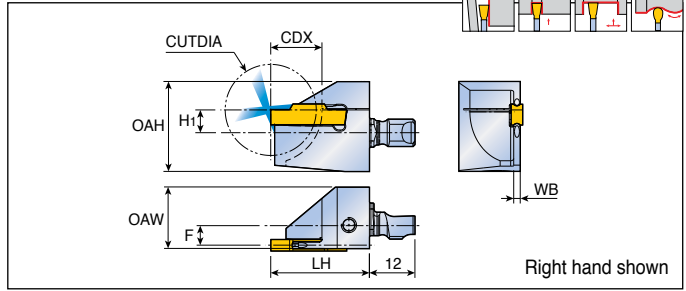

Designation	Insert seat size	Dimension (mm)									Shank	Insert
		OAH	LH	OAW	WB	CDX	CUTDIA	H ₁	F			
QE1 TTER 2-16-32-TB	2	23.7	26.0	16.2	1.8	16.0	32.0	6.0	6.1	QE1 S12N-TB	TDC / J / T	
2-12-24-TB	2	23.7	26.0	16.2	1.8	12.0	24.0	6.0	6.1	QE1 S16R-TB	TDXU / XT / XY	
3-16-32-TB	3	23.7	26.0	16.2	2.4	16.0	32.0	6.0	5.8	B61, B62	TSC / J	
3-12-24-TB	3	23.7	26.0	16.2	2.4	12.0	24.0	6.0	5.8		TDUF / TDV	
											B113-B121	

QE1 TTEL-TB

Modular heads for external turning and grooving with high pressure coolant



COOLBURST

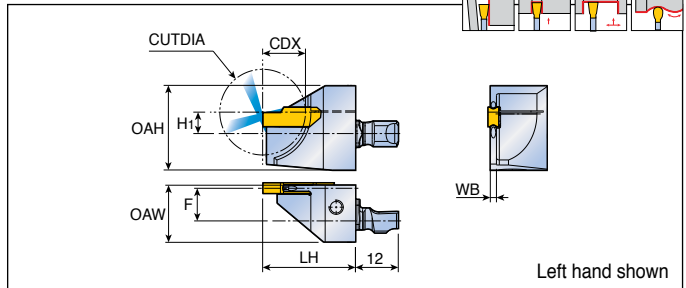

Designation	Insert seat size	Dimension (mm)									Shank	Insert
		OAH	LH	OAW	WB	CDX	CUTDIA	H ₁	F			
QE1 TTEL 2-16-32-TB	2	23.7	26.0	16.0	1.8	16.0	32.0	6.0	8.1	QE1 S12N-TB	TDC / J / T	
2-12-24-TB	2	23.7	26.0	16.0	1.8	12.0	24.0	6.0	8.1	QE1 S16R-TB	TDXU / XT / XY	
3-16-32-TB	3	23.7	26.0	16.0	2.4	16.0	32.0	6.0	7.8	B61, B62	TSC / J	
3-12-24-TB	3	23.7	26.0	16.0	2.4	12.0	24.0	6.0	7.8		TDUF / TDV	
											B113-B121	

Spare parts

Designation	Screw	Wrench		
QE1 TTER/L-TB	SH M4X0.7X16	L-W 3		

QE1 TQHR

Modular heads for parting and grooving

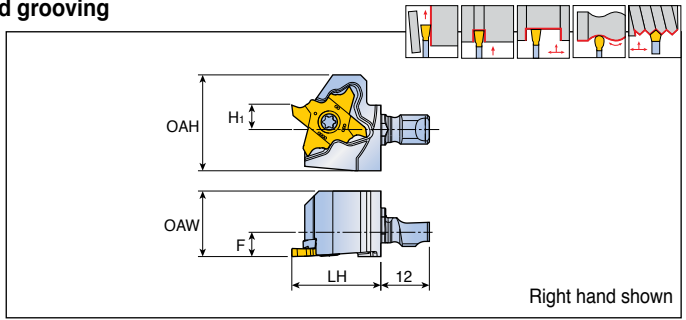

Designation	Dimension (mm)					Shank	Insert
	OAH	LH	OAW	H ₁	F		
QE1 TQHR 20	23.7	22.0	16.2	6.0	7.0	QE1 S12N-TB QE1 S16R-TB B61, B62	TQS 20 TQJ 20 B147-B148

QE1 TQHR-TB

Modular heads for parting and grooving with high pressure coolant



COOLBURST

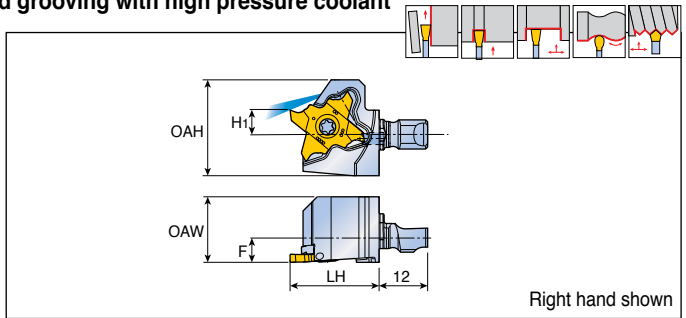

Designation	Dimension (mm)					Shank	Insert
	OAH	LH	OAW	H ₁	F		
QE1 TQHR 20-TB	23.7	22.0	16.2	6.0	7.0	QE1 S12N-TB QE1 S16R-TB B61, B62	TQS 20 TQJ 20 B147-B148

Spare parts

Designation	Screw	Wrench		
	QE1 TQHR(-TB)	 TS 40A100L	 T-1508/5	

TTER/L-SH



Parting and grooving holders for Swiss automatic lathes

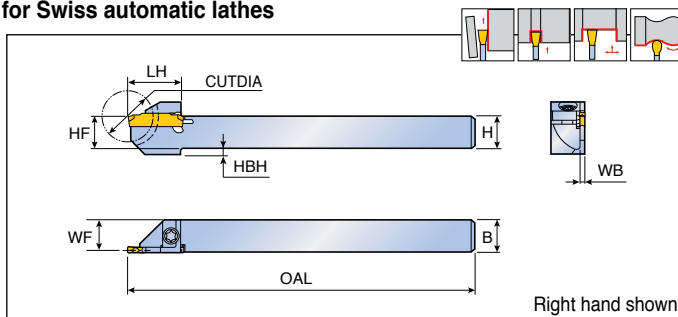

Designation	Insert seat size	Dimension (mm)								Insert
		H(HF)	B	OAL	LH	WF	WB	HBH	CUTDIA	
TTER/L 10-20-1.4SH	1 *	10	10	125	18	9.5	1.0	-	20	TDC / J / T TD XU / XT / XY TSC / J TDUF / TDV B113-B123
12-24-1.4SH	1 *	12	12	125	19.5	11.5	1.0	-	24	
14-24-1.4SH	1 *	14	14	125	19.5	13.5	1.0	-	24	
16-32-1.4SH	1 *	16	16	125	24	15.5	1.0	-	32	
10-20-2SH	2	10	10	125	19	9.1	1.8	2	20	
12-24-2SH	2	12	12	125	19	11.1	1.8	2	24	
14-24-2SH	2	14	14	125	19	13.1	1.8	-	24	
16-32-2SH	2	16	16	125	24	15.1	1.8	-	32	
12-24-3SH	3	12	12	125	19	10.8	2.4	2	24	
16-32-3SH	3	16	16	125	24	14.8	2.4	-	32	
16-38-3SH	3	16	16	125	27	14.8	2.4	-	38	
20-45-3SH	3	20	20	125	30.5	18.8	2.4	-	45	

* TDJ 1.4 insert only

Spare parts

Designation	Screw	Wrench		
TTER/L- SH	TS 40A115I	T 15		

TTER/L-SH-TB

Side lock holders with high pressure coolant for Swiss automatic lathes

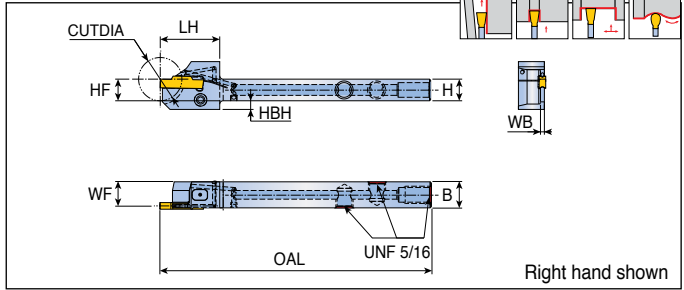

Designation	Insert seat size	Dimension (mm)								Insert
		H(HF)	B	OAL	LH	WF	WB	HBH	CUTDIA	
TTER/L 12-24-2SH-TB	2	12	12	125	27.5	11.1	1.8	2	24	TDC / J / T / A
16-32-2SH-TB	2	16	16	125	31.5	15.1	1.8	-	32	TDXU / XT / XY
12-24-3SH-TB	3	12	12	125	27.5	10.8	2.4	2	24	TSC / J
16-32-3SH-TB	3	16	16	125	31.5	14.8	2.4	-	32	TDFU / TDV
16-38-3SH-TB	3	16	16	125	34.5	14.8	2.4	-	38	B113-B123
20-45-3SH-TB	3	20	20	125	38	18.8	2.4	-	45	

• Please refer to B106 page for COOL-BURST accessories

Spare parts

Designation	Pin	Clamping screw	Pin plug	Inlet plug	Wrench	
TTER/L...SH-TB	PIN-SH-TB-L21	SS M5-24145	SS M5x3.5 ULTEM 2300	PLG 5/16 UNF	L-W 2.5F	L-W 5/32

TTER/L-D

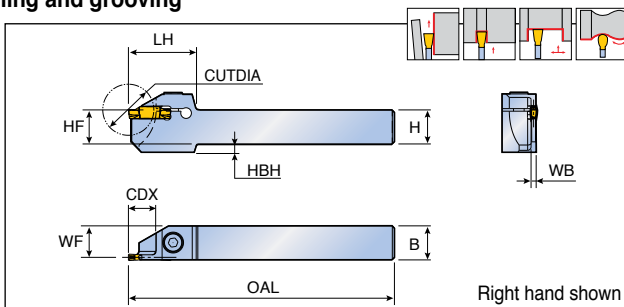

Reinforced holders for external turning and grooving



Designation	Insert seat size	Dimension (mm)									Insert	
		H(HF)	B	OAL	LH	WF	WB	HBH	CDX	CUTDIA		
TTER/L 1010-1.4T15-D40	1 *	10	10	125	32	9.5	1.0	6	15	40	TDC / J / T	
1212-1.4T15-D40	1 *	12	12	125	32	11.5	1.0	4	15	40	TDXU / XT / XY	
1616-1.4T20-D45	1 *	16	16	125	38	15.5	1.0	4	20	45	TSC / J	
2020-1.4T20-D45	1 *	20	20	125	38	19.5	1.0	-	20	45	TDUF / TDV	
1010-2T15-D40	2	10	10	125	32	9.1	1.8	6	15	40	 B113-B123	
1212-2T15-D40	2	12	12	125	32	11.1	1.8	4	15	40		
1616-2T20-D45	2	16	16	125	38	15.1	1.8	4	20	45		
2020-2T20-D45	2	20	20	125	38	19.1	1.8	-	20	45		
2525-2T20-D45	2	25	25	150	38	24.1	1.8	-	20	45		
1212-3T15-D40	3	12	12	125	32	10.8	2.4	4	15	40		
1616-3T20-D45	3	16	16	125	38	14.8	2.4	4	20	45		
2020-3T20-D45	3	20	20	125	38	18.8	2.4	-	20	45		
2525-3T20-D45	3	25	25	150	38	23.8	2.4	-	20	45		
2525-3T25-D60	3	25	25	150	43	23.8	2.4	-	25	60		

• * TDJ 1.4 insert only

Spare parts

Designation	Screw	Wrench		
				
TTER/L-D	SH M5x0.8x16	L-W 4		

Machining depth for diameter of workpiece

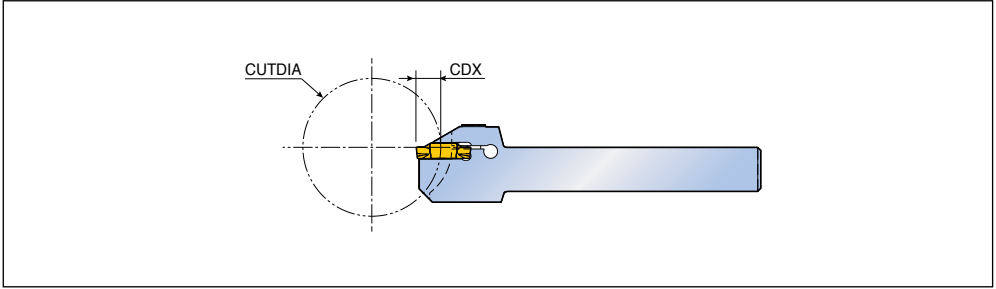

Designation	CUTDIA	CDX												
		1	2	3	4	5	6	7	8	9	10	11	12	13
TTER/L 1010-1.4T15-D40	CUTDIA					∞						269	120	79
1212-1.4T15-D40						∞						269	120	79
1616-1.4T20-D45						∞								432
2020-1.4T20-D45						∞								432
1010-2T15-D40						∞						269	120	79
1212-2T15-D40						∞						269	120	79
1616-2T20-D45						∞								432
2020-2T20-D45						∞								432
2525-2T20-D45						∞				1468	339	193	136	106
1212-3T15-D40						∞						269	120	79
1616-3T20-D45						∞								432
2020-3T20-D45						∞								432
2525-3T20-D45						∞				1468	339	193	136	106
2525-3T25-D60						∞								

Designation	CUTDIA	CDX												
		14	15	16	17	18	19	20	21	22	23	24	25	
TTER/L 1010-1.4T15-D40	CUTDIA	59	40											
1212-1.4T15-D40		59	40											
1616-1.4T20-D45		193	125	94	76	64	57	45						
2020-1.4T20-D45		193	125	94	76	64	57	45						
1010-2T15-D40		59	40											
1212-2T15-D40		59	40											
1616-2T20-D45		193	125	94	76	64	57	45						
2020-2T20-D45		193	125	94	76	64	57	45						
2525-2T20-D45		87	75	67	60	56	52	45						
1212-3T15-D40		59	40											
1616-3T20-D45		193	125	94	76	64	57	45						
2020-3T20-D45		193	125	94	76	64	57	45						
2525-3T20-D45		87	75	67	60	56	52	45						
2525-3T25-D60					1810	418	237	167	130	107	91	81	73	60

Holders for external turning and grooving

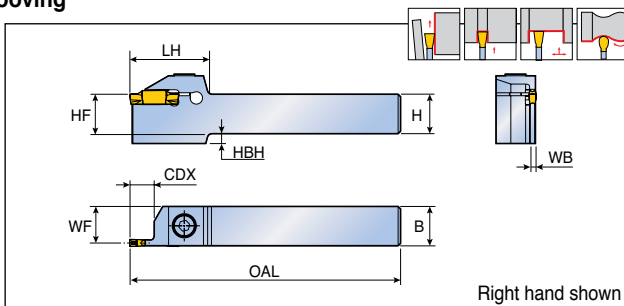

Designation	Insert seat size	Dimension (mm)								Insert
		H(HF)	B	OAL	LH	WF	WB	HBH	CDX	
TTER/L 1616-2T08	2	16	16	110	30.0	15.1	1.8	4	8	TDC / J / T / A
2020-2T08	2	20	20	125	30.0	19.1	1.8	-	8	TDXU / XT / XY
2525-2T08	2	25	25	150	30.0	24.1	1.8	-	8	TSC / J / A
1616-2	2	16	16	110	32.0	15.1	1.8	4	12	TDUF / TDV
2020-2	2	20	20	125	32.0	19.1	1.8	-	12	
2525-2	2	25	25	150	32.0	24.1	1.8	-	12	B113-B123,B126
1616-2T17	2	16	16	110	37.0	15.1	1.8	4	17	
2020-2T17	2	20	20	125	37.0	19.1	1.8	-	17	
2525-2T17	2	25	25	150	37.0	24.1	1.8	-	17	
TTER/L 1616-3T09	3	16	16	110	30.0	14.8	2.4	4	9	
2020-3T09	3	20	20	125	30.0	18.8	2.4	-	9	
2525-3T09	3	25	25	150	30.0	23.8	2.4	-	9	
1616-3	3	16	16	110	32.0	14.8	2.4	4	12	
2020-3	3	20	20	125	32.0	18.8	2.4	-	12	
2525-3	3	25	25	150	32.0	23.8	2.4	-	12	
1616-3T20	3	16	16	110	38.5	14.8	2.4	-	20	
2020-3T20	3	20	20	125	38.5	18.8	2.4	-	20	
2525-3T20	3	25	25	150	38.5	23.8	2.4	-	20	
2525-3T25	3	25	25	150	44.5	23.8	2.4	-	25	
3232-3T20	3	32	32	170	38.5	30.8	2.4	-	20	
TTER/L 1616-4T10	4	16	16	110	32.0	14.5	3.0	4	10	
2020-4T10	4	20	20	125	32.0	18.5	3.0	-	10	
2525-4T10	4	25	25	150	32.0	23.5	3.0	-	10	
1616-4	4	16	16	110	33.0	14.5	3.0	4	15	
2020-4	4	20	20	125	33.0	18.5	3.0	-	15	
2525-4	4	25	25	150	33.0	23.5	3.0	-	15	
1616-4T25	4	16	16	110	45.0	14.5	3.0	-	25	
2020-4T25	4	20	20	125	45.0	18.5	3.0	-	25	
2525-4T25	4	25	25	150	45.0	23.5	3.0	-	25	
2525-4T30	4	25	25	150	51.0	23.5	3.0	-	30	
3232-4T25	4	32	32	170	45.0	30.5	3.0	-	25	
TTER/L 2020-5T12	5	20	20	125	35.0	18.1	3.9	-	12	
2525-5T12	5	25	25	150	35.0	23.1	3.9	-	12	
2020-5	5	20	20	125	37.0	18.1	3.9	-	20	
2525-5	5	25	25	150	37.0	23.1	3.9	-	20	
2525-5T32	5	25	25	150	56.0	23.0	3.9	-	32	
3232-5T20	5	32	32	170	39.0	30.0	3.9	-	20	
3232-5T32	5	32	32	170	56.0	30.0	3.9	-	32	

Holders for external turning and grooving

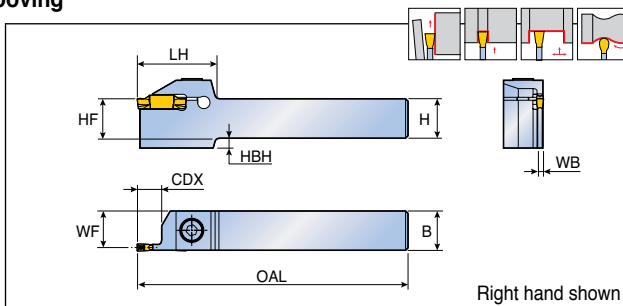
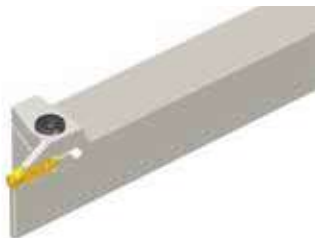

Designation	Insert seat size	Dimension (mm)								Insert
		H(HF)	B	OAL	LH	WF	WB	HBH	CDX	
TTER/L 2020-6T12	6	20	20	125	37	17.6	4.9	-	12	TDC / J / T / A
2525-6T12	6	25	25	150	37	22.6	4.9	7	12	TDXU / XT / XY
2020-6	6	20	20	125	41	17.6	4.9	-	20	TSC / J / A
2525-6	6	25	25	150	41	22.6	4.9	7	20	TDUF / TDV
2525-6T32	6	25	25	150	56	22.5	4.9	7	32	 B113-B123, B126
3232-6T20	6	32	32	170	41	29.5	4.9	-	20	
3232-6T25	6	32	32	170	46	29.5	4.9	-	25	
3232-6T32	6	32	32	170	56	29.5	4.9	-	32	
TTER/L 2525-8T16	8	25	25	150	40	22.1	5.9	7	16	
2525-8	8	25	25	150	47	22.1	5.9	7	25	
3232-8	8	32	32	170	47	29.1	5.9	-	25	
2525-8T36	8	25	25	150	60	22.1	5.9	7	36	
3232-8T36	8	32	32	170	60	29.1	5.9	-	36	
TTER/L 2525-10T25	10	25	25	150	50	21.1	7.9	7	25	
3232-10T25	10	32	32	170	50	28.1	7.9	-	25	
4040-10T25	10	40	40	200	50	36.1	7.9	-	25	

Spare parts

Designation	Screw	Wrench		
TTER/L 1616-2/3	SH M5x0.8x16	L-W 4		
TTER/L 2020-2/3	SH M5x0.8x20	L-W 4		
TTER/L 2525-2/3	SH M5x0.8x25	L-W 4		
TTER/L 3232-3	SH M5x0.8x25	L-W 4		
TTER/L 1616-4/5	SH M6x1x16	L-W 5		
TTER/L 2020-4/5	SH M6x1x20	L-W 5		
TTER/L 2525-4/5	SH M6x1x25	L-W 5		
TTER/L 3232-4/5	SH M6x1x25	L-W 5		
TTER/L 2020-6	SH M8x1.25x20	L-W 6		
TTER/L 2525-6/8	SH M8x1.25x25	L-W 6		
TTER/L 3232-6/8/10	SH M8x1.25x25	L-W 6		
TTER/L 4040-10	SH M8x1.25x25	L-W 6		

TTER/L-TB

Holders for turning and grooving with high pressure coolant

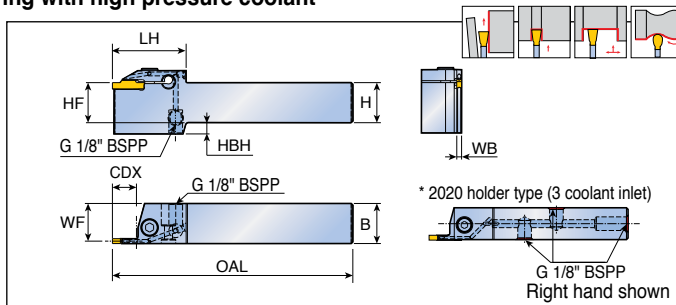

Designation	Insert seat size	Dimension (mm)								Insert
		H(HF)	B	OAL	LH	WF	WB	HBH	CDX	
TTER/L 2020-2T12-TB	2	20	20	125	43	19.1	1.8	-	12	TDC / J / T / A
2525-2T12-TB	2	25	25	150	43	24.1	1.8	-	12	TDXU / XT / XY
2020-3-TB	3	20	20	125	43	18.8	2.4	-	12	TSC / J / A
2020-4-TB	4	20	20	125	46	18.5	3.0	-	15	TDUF / TDV
2525-3-TB	3	25	25	150	43	23.8	2.4	-	12	B113-B123, B126
2525-3T25-TB	3	25	25	150	51	23.8	2.4	-	25	
2525-4-TB	4	25	25	150	46	23.5	3.0	-	15	
2525-5-TB	5	25	25	150	49	23.1	3.9	-	20	
2525-6-TB	6	25	25	150	52	22.6	4.9	7	20	
2525-8-TB	8	25	25	150	58	22.1	5.9	7	25	

• Please refer to B106 page for COOL-BURST accessories

Spare parts

Designation	Screw	Plug		Wrench
TTER/L 2020-2T12-TB	SH M5x0.8x20	PLG G1/8-L6.5	-	L-W 4, L-W 5
TTER/L 2525-2T12-TB	SH M5x0.8x20	-	PLG G1/8-T8.0-L12.3	L-W 4, L-W 5
TTER/L 2020-3-TB	SH M5x0.8x20	PLG G1/8-L6.5	-	L-W 4, L-W 5
TTER/L 2020-4-TB	SH M6x1.0x20	PLG G1/8-L6.5	-	L-W 5
TTER/L 2525-3-TB	SH M5x0.8x20	-	PLG G1/8-T8.0-L12.3	L-W 4, L-W 5
TTER/L 2525-4 / 5-TB	SH M6x1.0x20	-	PLG G1/8-T8.0-L12.3	L-W 5
TTER/L 2525-6 / 8-TB	SH M8x1.25x20	-	PLG G1/8-T8.0-L12.3	L-W 5, L-W 6

Holders for external turning and grooving

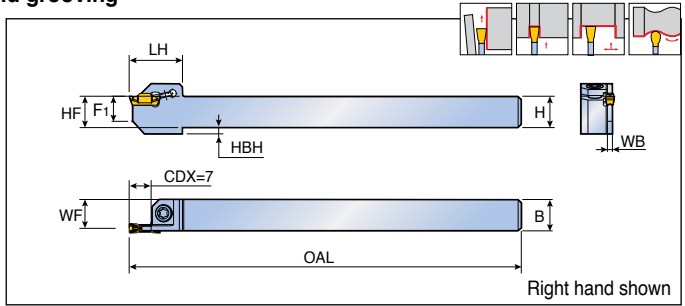

Designation	Insert seat size	Dimension (mm)								Insert
		H(HF)	B	OAL	LH	WF	WB	F1	HBH	
TTSER/L 1010-2T7	2	10	10	125	17	9.2	1.6	8	2	TDIM / TDIP B125
1212-2T7	2	12	12	125	17	11.2	1.6	8	-	
1616-2T7	2	16	16	125	20	15.2	1.6	11	-	
2020-2T7	2	20	20	125	20	19.2	1.6	14	-	
2525-2T7	2	25	25	125	20	24.2	1.6	18	-	
1010-3T7	3	10	10	125	17	8.8	2.4	8	2	
1212-3T7	3	12	12	125	17	10.8	2.4	8	-	
1616-3T7	3	16	16	125	20	14.8	2.4	11	-	
2020-3T7	3	20	20	125	20	18.8	2.4	14	-	
2525-3T7	3	25	25	125	20	23.8	2.4	18	-	

Spare parts

Designation	Screw	Wrench		
TTSER/L	TS 400971	T 15		

Holders for deep face grooving

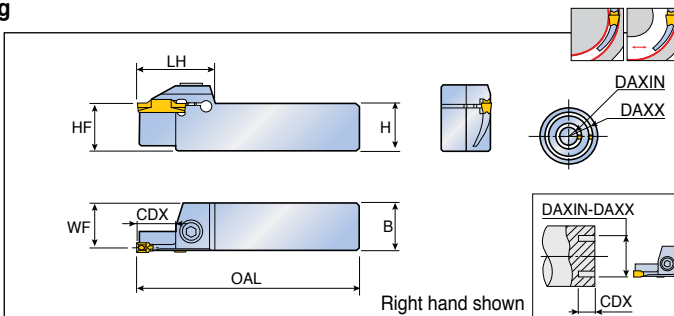
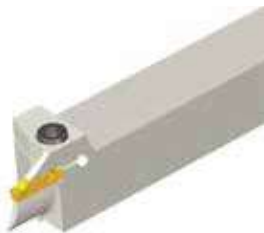

Designation	Insert seat size	Dimension (mm)								Insert	
		H(HF)	B	OAL	LH	WF	CDX	DAXIN	DAXX		
TTFR/L 25-30-3	3	25	25	150	32	24.0	10	24	35	TDC / J / T TDXU / XT / XY / FT TSC / J TDUF / TDV B113-B121,B123	
25-35-3	3	25	25	150	32	24.0	10	29	40		
25-40-3	3	25	25	150	32	24.0	10	34	50		
25-50-3	3	25	25	150	32	24.0	15	44	60		
25-60-3	3	25	25	150	32	24.0	15	54	85		
25-30-4	4	25	25	150	33	23.6	12	22	40		
25-40-4	4	25	25	150	33	23.6	15	32	50		
25-50-4	4	25	25	150	33	23.6	15	42	60		
25-60-4	4	25	25	150	33	23.6	15	52	85		
25-60-5	5	25	25	150	41	23.1	20	50	80		
25-80-5	5	25	25	150	41	23.1	20	70	110		
25-110-5	5	25	25	150	41	23.1	20	110	150		
25-150-5	5	25	25	150	41	23.1	20	140	200		
25-60-6	6	25	25	150	41	22.6	20	48	85		
25-85-6	6	25	25	150	41	22.6	20	73	150		
25-150-6	6	25	25	150	41	22.6	20	138	250		
25-250-6	6	25	25	150	41	22.6	20	250	∞		

• Please check insert min. dia for face grooving [B74](#) page

Spare parts

Designation	Screw	Wrench		
TTFR/L...-3	SH M5x0.8x25	L-W 4		
TTFR/L...-4	SH M6x1x25	L-W 5		
TTFR/L...-5	SH M8X1.25X25	L-W 5		
TTFR/L...-6	SH M8X1.25X25	L-W 5		

Holders for deep face grooving along shaft

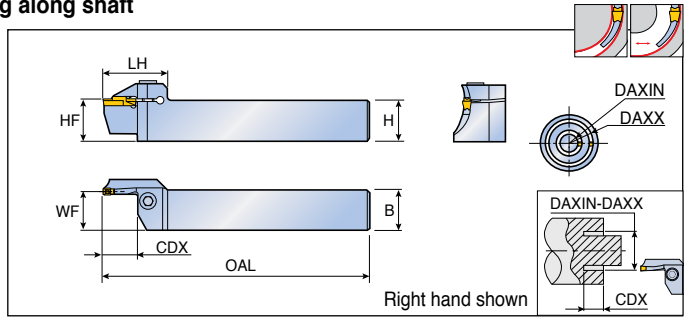

Designation	Insert seat size	Dimension (mm)								Insert
		H(HF)	B	OAL	LH	WF	CDX	DAXIN	DAXX	
TTFR/L 20-21-30-3T10 RN	3	20	20	140	31	19.0	10	21	30	TDC / J / T
20-24-35-3T10 RN	3	20	20	140	31	19.0	10	24	35	TDXU / XT / XY
20-29-40-3T10 RN	3	20	20	140	31	19.0	10	29	40	TDFT
20-34-50-3T10 RN	3	20	20	140	31	19.0	10	34	50	TSC / J
20-44-70-3T15 RN	3	20	20	140	35	19.0	15	44	70	TDUF / TDV
20-64-100-3T15 RN	3	20	20	140	35	19.0	15	64	100	
25-30-3 RN	3	25	25	150	35	24.0	10	24	35	B113-B121,B123
25-35-3 RN	3	25	25	150	35	24.0	10	29	40	
25-40-3 RN	3	25	25	150	35	24.0	10	34	50	
25-50-3 RN	3	25	25	150	35	24.0	15	44	70	
25-70-3 RN	3	25	25	150	35	24.0	15	64	100	
20-19-30-4T10 RN	4	20	20	140	31	18.6	10	19	30	
20-22-36-4T10 RN	4	20	20	140	31	18.6	10	22	36	
20-28-42-4T16 RN	4	20	20	140	36	18.6	16	28	42	
20-34-50-4T16 RN	4	20	20	140	36	18.6	16	34	50	
20-42-70-4T16 RN	4	20	20	140	36	18.6	16	42	70	
20-62-120-4T16 RN	4	20	20	140	36	18.6	16	62	120	
20-112-200-4T16 RN	4	20	20	140	36	18.6	16	112	200	
25-30-4 RN	4	25	25	150	35	23.6	10	22	36	
25-36-4 RN	4	25	25	150	39	23.6	20	28	42	
25-42-4 RN	4	25	25	150	39	23.6	20	34	50	
25-50-4 RN	4	25	25	150	39	23.6	20	42	70	
25-70-4 RN	4	25	25	150	39	23.6	20	62	120	
25-120-4 RN	4	25	25	150	39	23.6	20	112	200	
25-200-4 RN	4	25	25	150	39	23.6	20	200	∞	
25-60-5T15 RN	5	25	25	150	41	23.1	15	50	80	
25-60-5 RN	5	25	25	150	49	23.1	25	50	80	
25-80-5T15 RN	5	25	25	150	41	23.1	15	70	110	
25-80-5 RN	5	25	25	150	49	23.1	25	70	110	
25-110-5 RN	5	25	25	150	49	23.1	25	100	150	
25-150-5 RN	5	25	25	150	49	23.1	25	140	200	
25-200-5 RN	5	25	25	150	49	23.1	25	200	∞	

• Please check insert min. dia for face grooving B74 page

Holders for deep face grooving along shaft

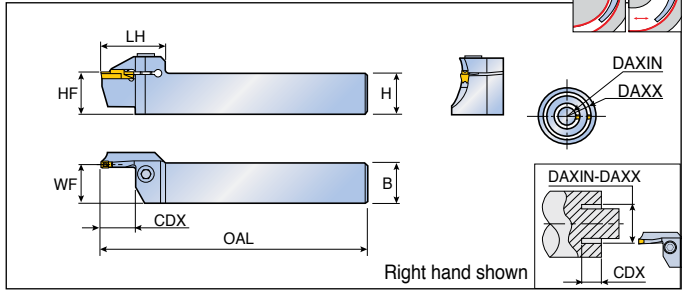

Designation	Insert seat size	Dimension (mm)								Insert
		H(HF)	B	OAL	LH	WF	CDX	DAXIN	DAXX	
TTFR/L 25-60-6 RN	6	25	25	150	49	22.6	25	48	70	TDC / J / T
25-70-6 RN	6	25	25	150	49	22.6	25	58	100	TDXU / XT / XY / FT
25-100-6 RN	6	25	25	150	49	22.6	25	88	180	TSC / J
25-180-6 RN	6	25	25	150	49	22.6	25	168	400	TDUF / TDV
25-400-6 RN	6	25	25	150	49	22.6	25	400	∞	B113-B121,B123

• Please check insert min. dia for face grooving [B74](#) page

Insert initial min. Dia (Dmin) for face grooving

Machining	Insert	Size (mm)	Min. dia. (mm)	Insert	Size (mm)	Min. dia. (mm)
Facing Min. dia. of face machining 	TDJ/C TDUF / TDV	3	54	TDT RU TDT RS	3	41
		4	34		4	36
		5	49		5	54
		6	46		6	54
	TDT	3	44	TDXU TDXT TDXY TDFT	3	18
		4	42		4	18
		5	50		5	20
		6	48		6	18

Spare parts

Designation	Screw	Wrench		
TTFR/L 20...RN	SH M6x1x20	L-W 5		
TTFR/L 25...3/4 RN	SH M6x1x25	L-W 5		
TTFR/L 25...5/6 RN	SH M8x1.25x25	L-W 6		

Perpendicular type holders for deep face grooving

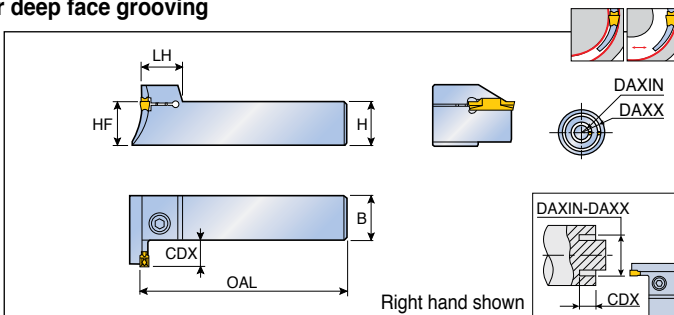

Designation	Insert seat size	Dimension (mm)							Insert
		H(HF)	B	OAL	LH	CDX	DAXIN	DAXX	
TTFPR/L 25-30-3	3	25	25	150	18.0	10	24	35	TDC / J / T
25-35-3	3	25	25	150	18.0	10	29	40	TDXU / XT / XY / FT
25-40-3	3	25	25	150	18.0	10	34	50	TSC / J
25-50-3	3	25	25	150	18.0	15	44	60	TDFU / TDV
25-60-3	3	25	25	150	18.0	15	54	85	B113-B121,B123
25-30-4	4	25	25	150	18.5	12	22	40	
25-40-4	4	25	25	150	18.5	15	32	50	
25-50-4	4	25	25	150	18.5	15	42	60	
25-60-4	4	25	25	150	18.5	15	52	85	
25-60-5	5	25	25	150	22.0	20	50	80	
25-80-5	5	25	25	150	22.0	20	70	110	
25-110-5	5	25	25	150	22.0	20	100	150	
25-150-5	5	25	25	150	22.0	20	140	200	
25-200-5	5	25	25	150	22.0	20	200	∞	
25-60-6	6	25	25	150	22.0	20	48	85	
25-85-6	6	25	25	150	22.0	20	73	150	
25-150-6	6	25	25	150	22.0	20	138	250	
25-250-6	6	25	25	150	22.0	20	250	∞	

• Please check insert min. dia for face grooving B74 page

Spare parts

Designation	Screw	Wrench		
TTFPR/L...-3	SH M5x0.8x25	L-W 4		
TTFPR/L...-4	SH M6x1x25	L-W 5		
TTFPR/L...-5	SH M8x1.25x25	L-W 6		
TTFPR/L...-6	SH M8x1.25x25	L-W 6		

Internal boring bars for shallow face grooving

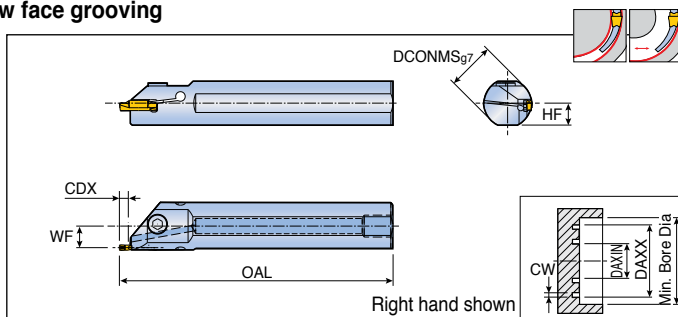

Designation	Insert seat size	Dimension (mm)					Insert
		DCONMS	OAL	WF	HF	CDX	
TGIFR/L 25-4C-T5.5	3, 4	25	200	11.3	11.5	5.5	TDC / J / T
32-4C-T5.5	3, 4	32	250	14.8	15.0	5.5	TDXU / XT / XY / FT
25-6C-T5.5	5, 6	25	200	10.3	11.5	5.5	TSC / J
32-6C-T5.5	5, 6	32	250	13.8	15.0	5.5	TDUF / TDV
							B113-B121, B123

• Please check insert min. dia for face grooving B74 page

CW	Min. Bore Dia		DAXIN				DAXX
	DCONMS ø25	DCONMS ø32	TDC/J/U/F/V	TDFT / TDXU / TDXT	TDT	TDT-RU/RS	
3	26.3	33.3	54	18	44	41	∞
4	26.8	33.8	34	18	42	36	
5	26.3	33.3	49	20	50	54	
6	26.8	33.8	46	18	48	54	

TGIFR/L Application

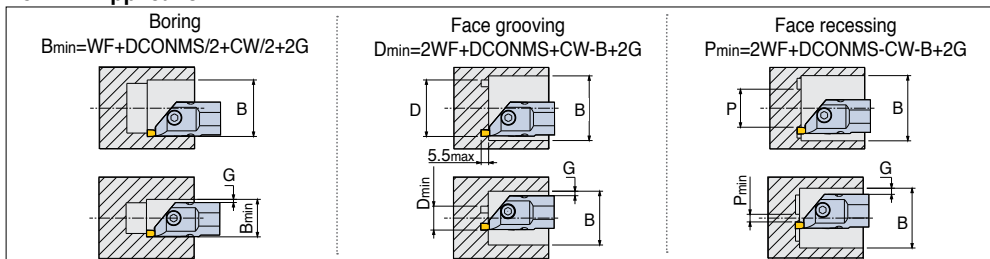

Spare parts

Designation	Screw	Wrench	Seal	
TGIFR/L 25	SH M6x1x16	L-W 5	PL 25 (R1/8")	
TGIFR/L 32	SH M6x1x16	L-W 5	PL 32 (R1/8")	

Internal boring bars for face grooving

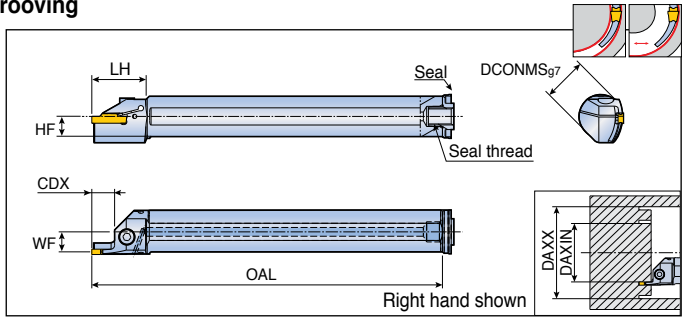

Designation	Insert seat size	Dimension (mm)									Insert
		DCONMS	OAL	LH	WF	HF	CDX	DAXIN	DAXX		
TTFIR/L 25-3T12 20-33	3	25	200	31	11.5	11.5	12	20	33	TDC / J / T	
25-3T12 26-39	3	25	200	31	11.5	11.5	12	26	39	TDXU / XT / XY	
25-3T12 33-48	3	25	200	31	11.5	11.5	12	33	48	TDFT	
25-3T12 42-60	3	25	200	31	11.5	11.5	12	42	60	TSC / J	
25-3T12 54-85	3	25	200	31	11.5	11.5	12	54	85	TDUF / TDV	
25-3T12 79-150	3	25	200	31	11.5	11.5	12	79	150		
25-4T12 18-34	4	25	200	31	11.0	11.5	12	18	34	B113-B121, B123	
25-4T12 26-42	4	25	200	31	11.0	11.5	12	26	42		
25-4T12 34-55	4	25	200	31	11.0	11.5	12	34	55		
32-4T12 47-70	4	32	250	31	14.5	15.0	12	47	70		
32-4T12 62-100	4	32	250	31	14.5	15.0	12	62	100		
32-4T12 92-180	4	32	250	31	14.5	15.0	12	92	180		

• Please check insert min. dia for face grooving [B74](#) page

Spare parts

Designation	Screw	Wrench	Seal	
TTFIR/L 25	SH M5x0.8x16	L-W 4	PL 25 (R1/8")	
TTFIR/L 32	SH M5x0.8x16	L-W 4	PL 32 (R1/8")	

TTIR/L-C

Internal boring bars for turning and grooving with coolant hole

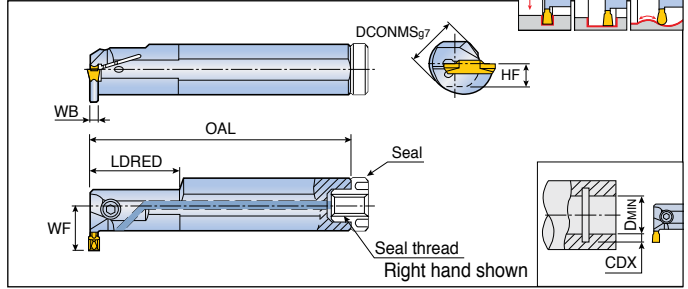

Designation	Insert seat size	Dimension (mm)								Insert
		DCONMS	OAL	LDRED	WF	HF	WB	CDX	Dmin	
TTIR/L 16-2C	2	16	125	-	16.5	7.5	1.8	8.5	25	TDC / J / T
20-2C	2	20	160	40	15.8	9.0	1.6	6.0	25	TDXU / XT / XY / IT
25-2C	2	25	200	40	17.5	11.5	1.6	5.0	25	TSC / J
32-2C-T8	2	32	250	40	24.8	14.0	1.8	8.0	36	TDUF / TDV
20-3C	3	20	160	40	15.8	9.0	2.1	6.0	25	B113-B124
25-3C	3	25	200	40	17.5	11.5	2.1	5.1	25	
25-3C-T8	3	25	200	40	21.5	11.5	2.4	8	32	
32-3C	3	32	250	60	20.8	14.0	2.1	4.7	31	
32-3C-T10	3	32	250	60	27.0	15.0	2.4	10	40	
40-3C-T12	3	40	300	65	33.0	19.0	2.4	12	50	
20-4C	4	20	160	40	15.8	9.0	2.9	6.0	25	
25-4C	4	25	200	40	17.5	11.5	2.9	5.2	25	
25-4C-T8	4	25	200	40	21.5	11.5	3.0	8	32	
32-4C	4	32	250	60	20.8	14.0	2.9	4.7	31	
32-4C-T10	4	32	250	60	27.0	15.0	3.0	10	40	
40-4C-T12	4	40	300	65	33.0	19.0	3.0	12	50	
50-4C-T14	4	50	350	70	40.0	23.5	3.0	14	60	
25-5C	5	25	200	40	17.3	11.5	3.9	5.2	31	
32-5C	5	32	250	60	20.8	14.0	3.9	4.7	31	
32-5C-T10	5	32	250	60	27.0	15.0	3.9	10	40	
40-5C-T12	5	40	300	65	33.0	19.0	3.9	12	50	
50-5C-T14	5	50	350	70	40.0	23.5	3.9	14	60	
32-6C	6	32	250	60	20.8	14.0	4.9	4.7	31	
32-6C-T10	6	32	250	60	27.0	15.0	4.9	10	40	
40-6C-T12	6	40	300	65	33.0	19.0	4.9	12	50	
50-6C-T14	6	50	350	70	40.0	23.5	4.9	14	60	
32-8C	8	32	250	60	21.3	14.5	5.9	5.5	37	
40-8C	8	40	300	65	25.8	19.0	5.9	5.8	42	

• Please check insert min. dia for internal grooving B80 page

Internal boring bars for turning and grooving

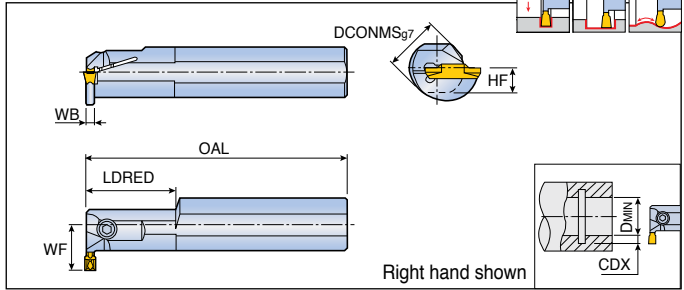

Designation	Insert seat size	Dimension (mm)								Insert
		DCONMS	OAL	LDRED	WF	HF	WB	CDX	DMIN	
TTIR/L 16-2	2	16	125	-	16.5	7.5	1.8	8.5	25	TDC / J / T TD XU / XT / XY / IT TSC / J TDUF / TDV B113-B124
20-2	2	20	160	40	15.8	9.0	1.6	6.0	25	
25-2	2	25	200	40	17.5	11.5	1.6	5.0	25	
32-2	2	32	250	60	20.8	14.0	1.5	4.7	31	
20-3	3	20	160	40	15.8	9.0	2.1	6.0	25	
25-3	3	25	200	40	17.5	11.5	2.1	5.1	25	
32-3	3	32	250	60	20.8	14.0	2.1	4.7	31	
20-4	4	20	160	40	15.8	9.0	2.9	6.0	25	
25-4	4	25	200	40	17.5	11.5	2.9	5.2	25	
32-4	4	32	250	60	20.8	14.0	2.9	4.7	31	

- Without "C" on the description: non-coolant hole type
- Please check insert min. dia for internal grooving B80 page

Machining	TDJ/C/UF/V		TDT		TDT RU/RS		TD XU / TDIT / TDXT / TDXY	
	Size (mm)	Min. dia. (mm)	Size (mm)	Min. dia. (mm)	Size (mm)	Min. dia. (mm)	Size (mm)	Min. dia. (mm)
Internal grooving Min. dia. of internal machining 	2	40	3	40	2	41	2	24
	3	50	4	40	3	38	3	24
	4	50	5	50	4	38	4	21
	5	60	6	50	5	43	5	30
	6	60	8	62	6	46	6	31
	8	70			8	56	8	33

Spare parts

Designation	Screw 	Wrench 	Seal *
TTIR/L 16-2	SH M5x0.8x10	L-W 4	PL 16 (M6)
TTIR/L 20-2/3/4	SH M5x0.8x12	L-W 4	PL 20 (M6)
TTIR/L 25-2/3/4	SH M5x0.8x16	L-W 4	PL 25 (R1/8")
TTIR/L 32-2/3/4	SH M5x0.8x16	L-W 4	PL 32 (R1/8")
TTIR/L 40-3/4	SH M5x0.8x16	L-W 4	PL 40 (R1/8")
TTIR/L 50-4	SH M5x0.8x20	L-W 4	PL 40 (R1/8")
TTIR/L 25-5/6	SH M6x1x16	L-W 5	PL 25 (R1/8")
TTIR/L 32-5/6	SH M6x1x20	L-W 5	PL 32 (R1/8")
TTIR/L 40/50-5/6	SH M6x1x25	L-W 5	PL 40 (R1/8")

* For through coolant type only

TTIR/L-TB

Internal boring bars for turning and grooving with high pressure coolant

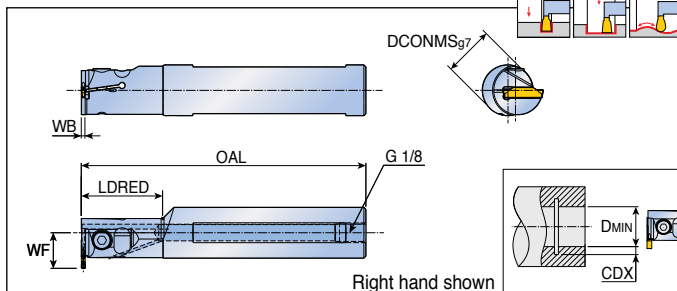

Designation	Insert seat size	Dimension (mm)							Insert
		DCONMS	OAL	LDRED	WF	WB	CDX	DMIN	
TTIR/L 20-2T06-TB	2	20	120	40	17	1.8	6	27	TDC / J / T
25-2T06-TB	2	25	150	40	19.5	1.8	6	29	TDXU / XT / XY
20-3T06-TB	3	20	120	40	17	2.4	6	27	TSC / J
25-3T06-TB	3	25	150	40	19.5	2.4	6	29	TDUF / TDV
32-3T10-TB	3	32	150	60	27	2.4	10	40	B113-B124
TTIR 20-4T06-TB	4	20	120	40	17	3	6	27	
25-4T06-TB	4	25	150	40	19.5	3	6	29	
32-4T10-TB	4	32	150	60	27	3	10	40	

- Please refer to B106 page for COOL-BURST accessories
- Please check insert min. dia for internal grooving B80 page

Spare parts

Designation	Screw	Wrench		
TTIR/L-20-TB	SH M5X0.8X12	L-W 4		
TTIR/L-25/32-TB	SH M5X0.8X16	L-W 4		

Internal boring bars for turning and grooving on small diameter

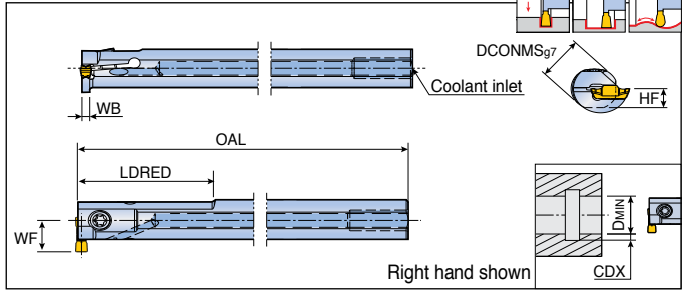

Designation	Insert seat size	Dimension (mm)								Coolant inlet	Insert
		DCONMS	OAL	LDRED	WF	HF	WB	CDX	DMIN		
TTSIR/L 10-12.5-2	2	10	125	25	7.5	4.5	1.6	2.4	12.5	Ø4	TDIM / TDIP B125
12-14-2	2	12	125	35	9.1	5.5	1.6	2.6	14.0	Ø6	
16-12.5-2	2	16	150	20	10.5	7.5	1.6	2.4	12.5	-	
16-14-2	2	16	150	25	11.0	7.5	1.6	2.6	14.0	-	
16-16-2	2	16	150	40	11.0	7.5	1.6	3.0	16.0	-	
12-14-3	3	12	125	35	9.1	5.5	2.0	2.6	14.0	Ø6	
16-12.5-3	3	16	150	20	10.5	7.5	2.0	2.4	12.5	-	
16-14-3	3	16	150	25	11.0	7.5	2.0	2.6	14.0	-	
16-16-3	3	16	150	40	11.0	7.5	2.0	3.0	16.0	-	
20-20-3	3	20	150	40	14.0	9.0	2.0	4.0	20.0	-	

Spare parts

Designation	Screw	Wrench	Seal	
TTSIR/L 10/12	TS 40093I	T 15	-	
TTSIR/L 16-12/14	TS 40093I	T 15	PL 16 (M6)	
TTSIR/L 16-16	TS 50125I	T 20	PL 16 (M6)	
TTSIR/L 20	TS 50125I	T 20	PL 20 (M6)	

Internal boring bars for shallow grooving on small diameter

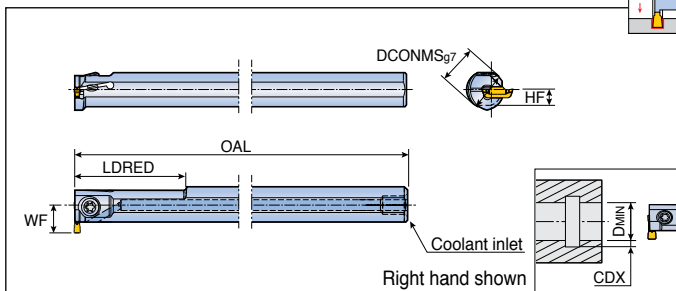

Designation	Insert seat size	Dimension (mm)								Coolant inlet	Insert
		DCONMS	OAL	LDRED	WF	HF	CDX	DMIN			
TGSIR/L 10-13-2	2, 3	10	125	25	7.6	5	2.5	12.5	Ø4	TDIM / TDIP	
12-14-2	2, 3	12	125	32	9.0	6	2.5	14.0	Ø6	B125	
16-13-2	2, 3	16	150	20	10.6	8	2.5	13.0	-		
16-14-2	2, 3	16	150	25	10.9	8	2.5	14.0	-		
16-16-2	2, 3	16	150	40	10.5	8	2.5	16.0	-		

Spare parts

Designation	Screw	Wrench	Seal	
TGSIR/L 10/12	TS 40093I	T 15	-	
TGSIR/L 16	TS 40093I	T 15	PL 16 (M6)	

Holders for external wide grooving and profiling

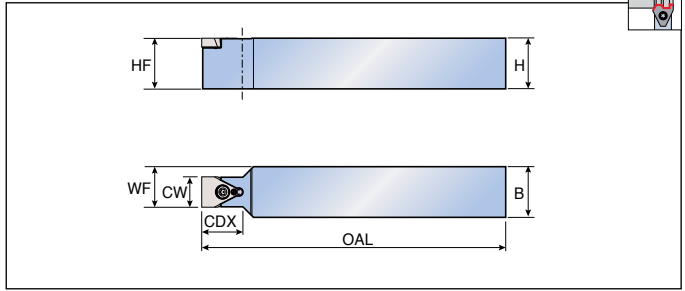

Designation	Dimension (mm)							Insert ⁽¹⁾
	H	HF	B	OAL	WF	CDX	CW	
TTLEN 1212 K10	12	12	12	125	11.0	20	10	TGUX B128
1616 K10	16	16	16	125	13.0	20	10	
2020 M10	20	20	20	150	15.0	20	10	
2525 M10	25	25	25	150	17.5	20	10	
1616 K15	16	16	16	125	15.5	20	15	
2020 M15	20	20	20	150	17.5	20	15	
2525 M15	25	25	25	150	20.0	20	15	
2020 K20	20	20	20	125	20.0	35	20	
2525 M20	25	25	25	150	22.5	35	20	
3232 P20	32	32	32	170	26.0	35	20	
2020 K25	20	20	20	125	22.5	35	25	
2525 M25	25	25	25	150	25.0	35	25	
3232 P25	32	32	32	170	28.5	35	25	

⁽¹⁾ Designation of final insert will be different to the semi finished blank

Spare parts

Designation	Screw	Wrench		
TTLEN ...K10/K15/M10/M15	TS 40B100I	T 15		
TTLEN ...K20/M20/P20	TS 45120I	T 20		
TTLEN ...K25/M25/P25	TS 45120I	T 20		

TQHR/L-20-TB



Holders for parting and grooving for Swiss type automatic lathes with high pressure coolant

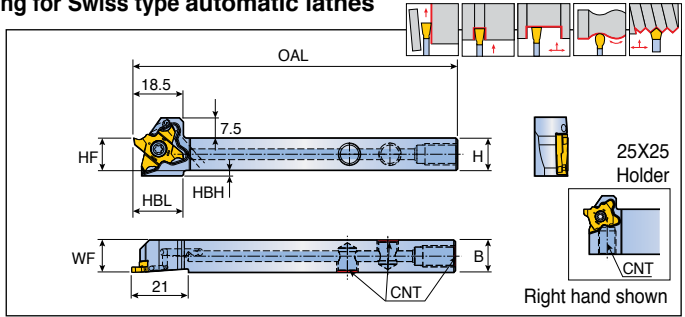

Designation	Dimension (mm)							CNT	Insert
	H	HF	B	WF	OAL	HBL	HBH		
TQHR/L 12-20-TB	12	12	12	12	120	18.5	2	UNF 5/16	TQS 20 TQJ 20 B147-B148
16-20-TB	16	16	16	16	120	-	-	UNF 5/16	
20-20-TB	20	20	20	20	120	-	-	G 1/8	
25-20-TB	25	25	25	25.3	135	-	-	G 1/8	

• Please refer to B106 page for COOL-BURST accessories

Spare parts

Designation	Screw	Plug	Wrench	
TQHR/L 12/16-20-TB	TS 40A100L ⁽¹⁾ TS 40A100 ⁽²⁾	PLG 5/16 UNF	T-1508/5	L-W 5/32
TQHR/L 20-20-TB		PLG G1/8-L6.5	T-1508/5	L-W 5
TQHR/L 25-20-TB		-	T-1508/5	-

• ⁽¹⁾ For TQHR • ⁽²⁾ For TQHL

TQBR/L-27

Blades for parting and grooving

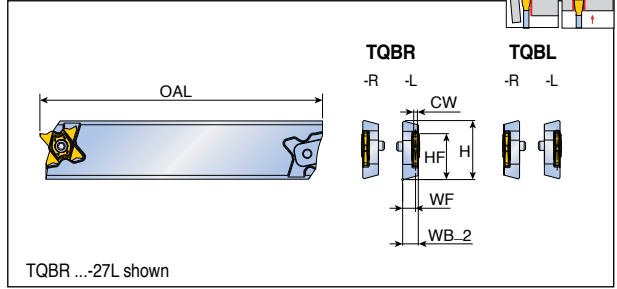

Designation	Dimension (mm)						Block	Insert
	H	HF	OAL	WF *	WB_2	CW range		
TQBR/L 26-27R	26	21.4	150	7	8.5	$0.5 \leq CW < 5.3$	TTBN/U...-26	TQ. 27
26-27L	26	21.4	150	7	8.5	$0.5 \leq CW < 5.3$	TTBN/U...-26	
32-27R	32	24.9	150	7	8.5	$0.5 \leq CW < 5.3$	TTBN/U...-32	B149-B157
32-27L	32	24.9	150	7	8.5	$0.5 \leq CW < 5.3$	TTBN/U...-32	B44-B45

* : To the center of inserts up to 3.2mm width

Spare parts

Designation	Screw	Wrench		
TQBR/L 26-27R	TS 50125I	T 10/20		
TQBR/L 26-27L	TS 50125IL	T 10/20		
TQBR/L 32-27R	TS 50125I	T 10/20		
TQBR/L 32-27L	TS 50125IL	T 10/20		

TQHR/L-27



Holders for parting and grooving

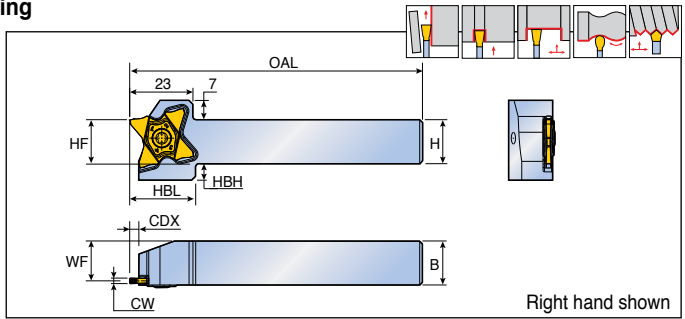

Designation	Dimension (mm)								Insert
	H	HF	B	OAL	WF	HBL	HBH	CW range	
TQHR/L 10-27	10	10	10	120	8.5	24	9	0.5 ≤ CW < 5.3	TQ.. 27
12-27	12	12	12	120	10.5	24	8	0.5 ≤ CW < 5.3	B149-B157
16-27	16	16	16	120	14.5	24	6	0.5 ≤ CW < 5.3	
20-27	20	20	20	120	18.5	24	2	0.5 ≤ CW < 5.3	
25-27	25	25	25	135	23.5	-	-	0.5 ≤ CW < 5.3	TQS 27 Special
16-27-8⁽¹⁾	16	16	16	120	14.0	24	6	5.3 ≤ CW ≤ 8.2	
20-27-8⁽¹⁾	20	20	20	120	18.0	24	2	5.3 ≤ CW ≤ 8.2	
25-27-8⁽¹⁾	25	25	25	135	23.0	-	-	5.3 ≤ CW ≤ 8.2	

• ⁽¹⁾ Only for TQS wider inserts from 5.3mm-8.2mm width

Spare parts

Designation	Screw	Wrench		
TQHR/L 10/12/16/20/25	TS 50125I ⁽¹⁾	T 10/20		
	TS 50125IL ⁽²⁾	T 10/20		
TQHR/L 16/20/25-27-8	TS 50170I-IC ⁽³⁾	T 15		
	TS 50170IL-IC ⁽⁴⁾	T 15		

• ⁽¹⁾⁽³⁾ For left holder • ⁽²⁾⁽⁴⁾ For right holder

TQHR/L-27-TB



Holders for parting and grooving with high pressure coolant



COOLBURST

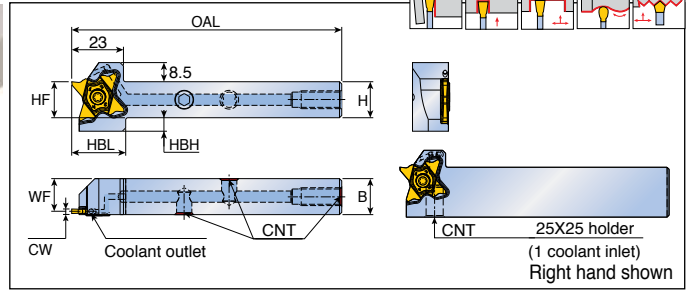

Designation	Dimension (mm)							CNT	Insert
	H(HF)	B	OAL	WF	HBL	HBH	CW range		
TQHR/L 12-27-TB	12	12	120	10.5	24	8	0.5 ≤ CW < 5.3	UNF 5/16	TQ. 27
16-27-TB	16	16	120	14.5	24	6	0.5 ≤ CW < 5.3	UNF 5/16	B149-B157
20-27-TB	20	20	120	18.5	24	2	0.5 ≤ CW < 5.3	G1/8 BSPP	
25-27-TB	25	25	135	23.5	-	-	0.5 ≤ CW < 5.3	G1/8 BSPP	

Please refer to B106 page for COOL-BURST accessories

Spare parts

Designation	Screw	Plug	Wrench	
TQHR/L 12-27-TB	TS 50125I ⁽¹⁾ TS 50125IL ⁽²⁾	PLG 5/16 UNF	T 10/20	L-W 5/32
TQHR/L 16-27-TB		PLG 5/16 UNF	T 10/20	L-W 5/32
TQHR/L 20-27-TB		PLG G1/8-L6.5	T 10/20	L-W 5
TQHR/L 25-27-TB		-	T 10/20	-

⁽¹⁾ For TQHL ⁽²⁾ For TQHR

TQHPR/L-27



Perpendicular type holders for parting and grooving

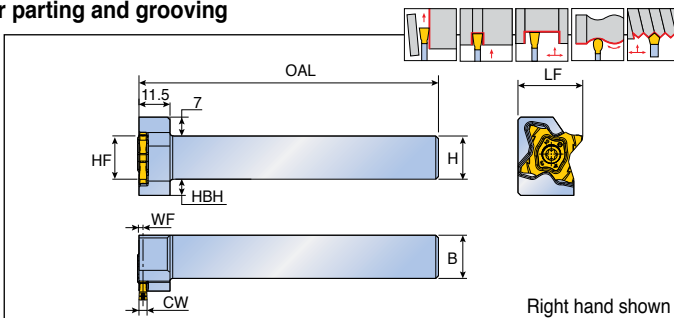

Designation	Dimension (mm)								Insert
	H	HF	B	WF	OAL	LF	HBH	CW range	
TQHPR/L 16-27	16	16	16	1.5	120	24	6	$0.5 \leq CW < 5.3$	TQ. 27
20-27	20	20	20	1.5	120	28	2	$0.5 \leq CW < 5.3$	B149-B157
25-27	25	25	25	1.5	135	33	-	$0.5 \leq CW < 5.3$	
20-27-8⁽¹⁾	20	20	20	2.0	120	28	2	$5.3 \leq CW \leq 8.2$	TQS 27 Special
25-27-8⁽¹⁾	25	25	25	2.0	135	33	-	$5.3 \leq CW \leq 8.2$	

⁽¹⁾ Only for TQS wider inserts from 5.3mm-8.2mm width

Spare parts

Designation	Screw	Wrench		
TQHPR/L 16/20/25	TS 50125I ⁽¹⁾	T 20		
	TS 50125IL ⁽²⁾	T 20		
TQHPR/L 16/20/25-8	TS 50170I-IC ⁽³⁾	T 15		
	TS 50170IL-IC ⁽⁴⁾	T 15		

⁽¹⁾⁽³⁾ For right holder ⁽²⁾⁽⁴⁾ For left holder

TQHR/L-34

Holders for parting and grooving

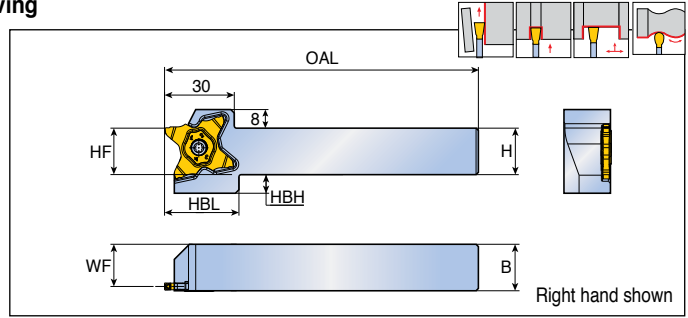

Designation	Dimension (mm)							Insert
	H	HF	B	WF	OAL	HBL	HBH	
TQHR/L 16-34	16	16	16	14.2	135	32	12	TQC 34
20-34	20	20	20	18.2	135	32	8	B157-B159
25-34	25	25	25	23.2	135	32	3	
32-34	32	32	32	30.2	135	-	-	

Spare parts

Designation	Screw	Wrench		
	TQHR/L-34	 TS 50125I ⁽¹⁾ TS 50125IL ⁽²⁾	 T 10/20	

• ⁽¹⁾ For left holder, ⁽²⁾ For right holder

TQHR/L-34-TB



HOLDERS for parting and grooving with high pressure coolant



COOLBURST

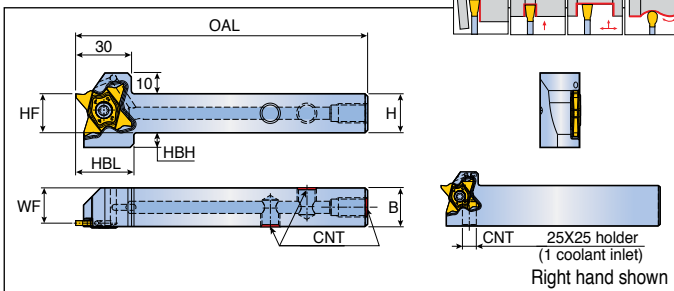

Designation	Dimension (mm)							CNT	Insert
	H	HF	B	WF	OAL	HBL	HBH		
TQHR/L 16-34-TB	16	16	16	14.2	135	32	12	UNF 5/16	TQC 34
20-34-TB	20	20	20	18.2	135	32	8	G 1/8	B157-B159
25-34-TB	25	25	25	23.2	135	32	3	G 1/8	

• Please refer to B106 page for COOL-BURST accessories

Spare parts

Designation	Screw	Plug	Wrench	
TQHR/L 16-34-TB	TS 50125I ⁽¹⁾ TS 50125IL ⁽²⁾	PLG 5/16 UNF	T 10/20	L-W 5/32
TQHR/L 20-34-TB		PLG G1/8-L6.5	T 10/20	L-W 5
TQHR/L 25-34-TB		-	T 10/20	-

• ⁽¹⁾ For left holder, ⁽²⁾ For right holder

TQHPR/L-34



Perpendicular type holders for parting and grooving

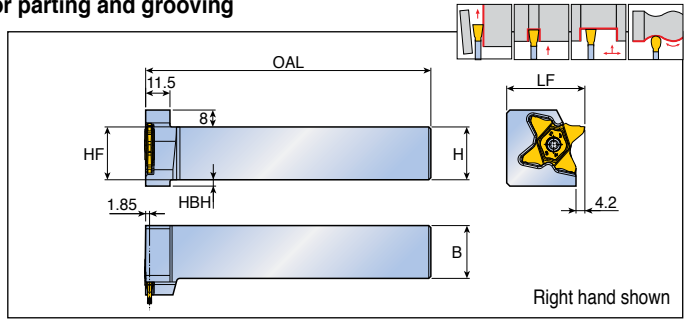

Designation	Dimension (mm)						Insert
	H	HF	B	OAL	LF	HBH	
TQHPR/L 20-34	20	20	20	135	32	8	TQC 34
25-34	25	25	25	135	37	3	 B157-B159

Spare parts

Designation	Screw	Wrench		
	 TS 50125I ⁽¹⁾ TS 50125IL ⁽²⁾	 T 10/20		

• ⁽¹⁾ For right holder, ⁽²⁾ For left holder

TMIHN



Internal boring bars for shallow grooving with coolant hole on small diameter

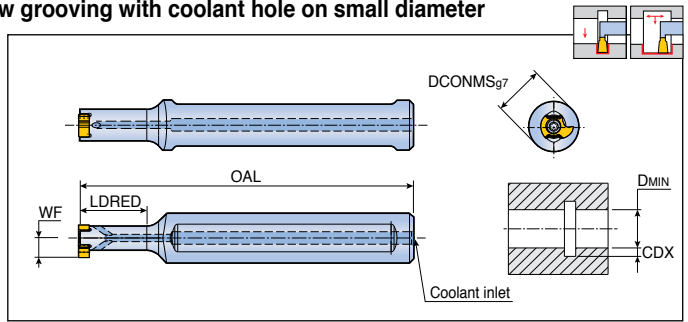

Designation	Dimension (mm)					Coolant inlet	Insert
	DCONMS	OAL	LDRED	WF	DMIN		
TMIHN 12-16-8	12	80	16	4.7	10	Ø3	TMIS 8 B161

• CDX: Refer to insert dimension

TMIHN-C



Internal carbide boring bars for shallow grooving with coolant hole on small diameter

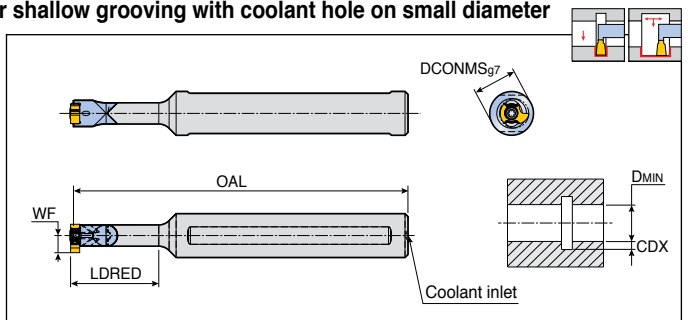

Designation	Dimension (mm)					Coolant inlet	Insert
	DCONMS	OAL	LDRED	WF	DMIN		
TMIHN 12C-24-8	12	92	24	4.7	10	Ø2	TMIS 8
12C-32-8	12	100	32	4.7	10	Ø2	B161

• CDX: Refer to insert dimension

Spare parts

Designation	Screw	Wrench		
TMIHN	TS 220521/HG	T 7		
TMIHN -C	TS 220521/HG	T 7		

Hose

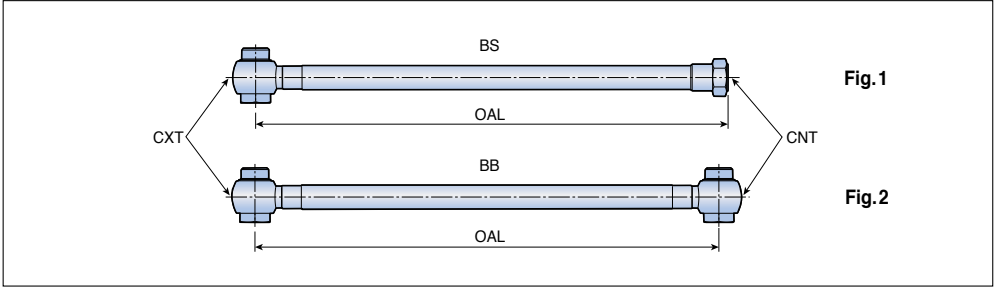

Designation	Dimension				Max.pressure (Bar)	Fig.
	OAL (mm)	CXT	CNT			
TB HOSE G1/8-7/16-200BS	200	G1/8"-28 BSPP	7/16"-20 UNF (Flare 37°)		260	1
G1/8-7/16-250BS	250	G1/8"-28 BSPP	7/16"-20 UNF (Flare 37°)		260	1
G1/8-G1/8-200BB	200	G1/8"-28 BSPP	G1/8"-28 BSPP		260	2
G1/8-G1/8-250BB	250	G1/8"-28 BSPP	G1/8"-28 BSPP		260	2
5/16-7/16-200BS	200	5/16"-24 UNF	7/16"-20 UNF (Flare 37°)		200	1
5/16-G1/8-200BS	200	5/16"-24 UNF	G1/8"-28 BSPP		200	1

• Hose is ordered separately

Adapter

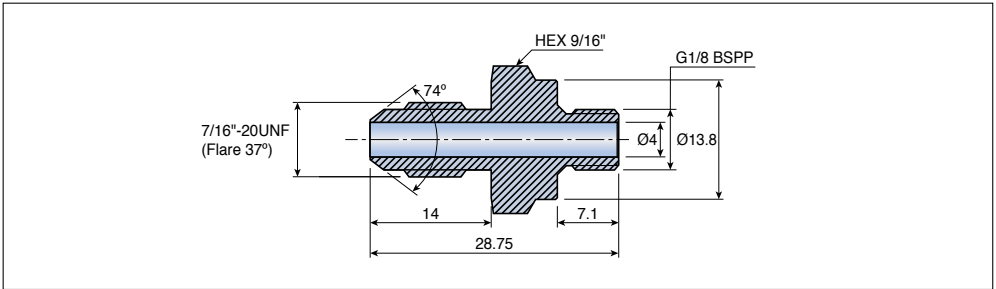

Designation
TB NIPPLE G1/8-7/16 UNF

• Adapter is ordered separately

Seal washer

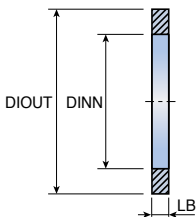

Designation	Dimension (mm)		
	DIOUT	DINN	LB
TB COPPER SEAL 1/8"	15	10	1
SEAL 5/16"	12	8	1

- Seal washer is ordered separately

Connector

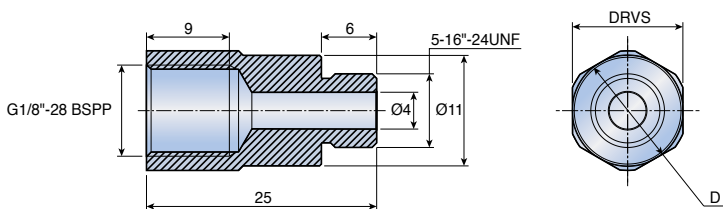

Designation	Dimension (mm)	
	D	DRVS
TB CONECTOR 5/16"-G1/8"	13	12
5/16"-G1/8"-12	12	11

- Connector is ordered separately

Parting & Grooving Inserts and Solid Bars





1 TaeguTec

2 Cutting edge type

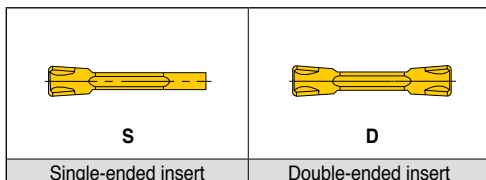

3 Chip breaker type

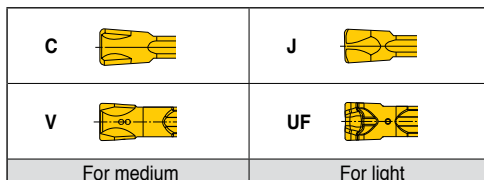

4 Width of insert

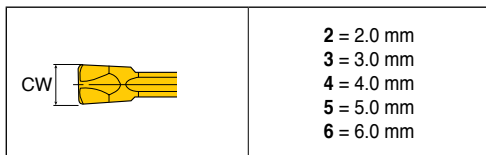

5 Lead angle

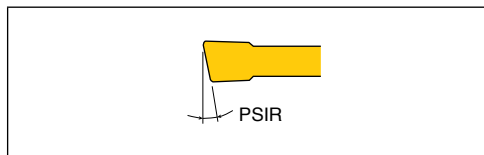

6 Hand of insert

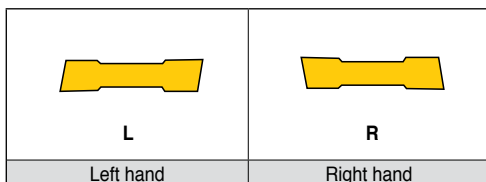

7 Corner type

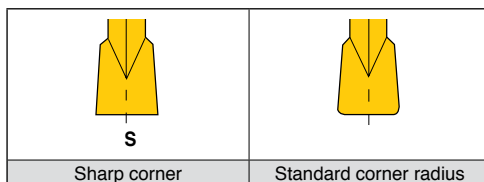

Insert Designation System



Turning, grooving and face machining

T D (F) T 3.00 E - 0.40 R

1 2 3 4 5 6 7 8

1 TaeguTec





2 Cutting edge type

S 	D 
Single-ended insert	Double-ended insert

3 Application type

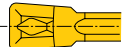
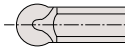
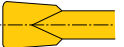
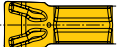
F Face turning and grooving
I Internal turning and grooving
X Universal

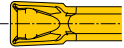
4 Chip breaker type

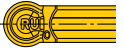
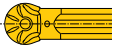
T 	A 	G 	M 	P 
For steel, high-temp. alloy and cast iron	For aluminum	Without chip breaker	Pressed for small diameter	Ground for small diameter
XU 	XY 	RU 	RS 	
Universal chip breaker (General)	Universal chip breaker (Roughing)	General profiling	Precision profiling	

5 Width of insert (mm)

CW 	<input type="checkbox"/> Precision insert
	<input type="checkbox"/> Pressed insert



6 Application type

E	For turning and grooving
No designation	For precision grooving

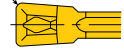
7 Corner radius (mm)

RE 	<input type="checkbox"/> Precision insert
	<input type="checkbox"/> Pressed insert

8 Hand of insert - For face machining

L 	R 
Left hand insert on left hand holder	Right hand insert on right hand holder

Single-ended inserts for parting and deep grooving with C-Type chip breaker

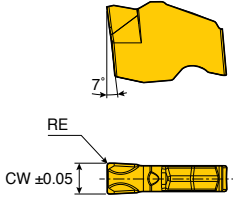

Size	Dimension (mm)			
	CW	RE		
1.6	1.6	0.2		
2	2.0	0.2		
3	3.0	0.2		

Insert	Designation	Insert seat size	Feed (mm/rev)	Cermet		Coated				Uncoated		
				CT3000		TT7505	TT6080	TT5100	TT9080	TT7220	TT8020	K10
	SFC 1.6	1	0.05-0.15						●	●		
	2	2	0.08-0.20						●	●	●	
	3	3	0.10-0.25						●	●	●	

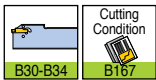

●: Standard items

SFJ

Single-ended inserts for parting and deep grooving with J-Type chip breaker

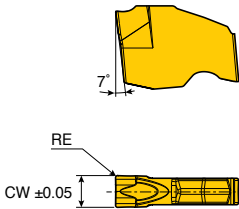

Size	Dimension (mm)			
	CW	RE		
2	2.0	0.2		
3	3.0	0.2		

Insert	Designation	Insert seat size	Feed (mm/rev)	Cermet		Coated				Uncoated		
				CT3000		TT7505	TT6080	TT5100	TT9080	TT7220	TT8020	K10
	SFJ 2	2	0.05-0.15						●	●	●	
	3	3	0.08-0.20						●	●	●	

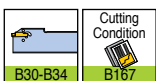

●: Standard items

Double-ended inserts for parting and grooving with C-Type chip breaker

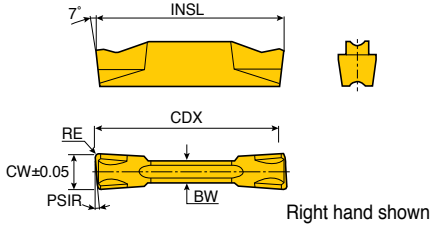

Size	Dimension (mm)					
	CW	RE	BW	INSL	PSIR	CDX
2 (.R/L)	2.0	0.20	1.7	20.0	0-15	19
2 RS/LS	2.0	0.02	1.7	19.6	15	19
3 (.R/L)	3.0	0.20	2.4	20.0	0-15	19
3 RS/LS	3.0	0.02	2.4	19.6	6-15	19
3.18	3.18	0.20	2.4	20.0	-	19
4 (.R/L)	4.0	0.30	3.0	20.0	0-15	19
5 (.R/L)	5.0	0.30	4.0	25.0	0-4	24
6	6.0	0.30	5.0	25.0	-	24
8	8.0	0.40	6.0	30.0	-	29

Insert	Designation	Insert seat size	Feed (mm/rev)	Cermet		Coated				Uncoated		
				CT3000		TT7505	TT6080	TT5100	TT9080	TT7220	TT8020	K10
	TDC 2	2	0.05-0.18	●					●	●	●	●
	2-6R/L	2	0.04-0.14						●	●	●	●
	2-8R/L	2	0.04-0.14							●	●	
	2-15R/L	2	0.04-0.12						●	●	●	
	2-15RS/LS	2	0.02-0.12						●	●	●	
	3	3	0.07-0.25	●			●		●	●	●	●
	3-6R/L	3	0.06-0.18						●	●	●	●
	3-6RS/LS	3	0.03-0.18						●	●		
	3-15R/L	3	0.06-0.16						●	●	●	
	3-15RS/LS	3	0.03-0.16							●	●	
	3.18	3	0.07-0.25						●		●	
	4	4	0.08-0.30	●					●	●	●	●
	4-4R/L	4	0.06-0.24						●	●	●	●
	4-15R/L	4	0.06-0.22							●	●	
	5	5	0.09-0.35						●	●	●	●
	5-4R/L	5	0.07-0.28						●	●	●	●
	6	6	0.12-0.40						●	●	●	●
	8	8	0.14-0.43						●		●	



●: Standard items

Single-ended inserts for parting and deep grooving with J-Type chip breaker

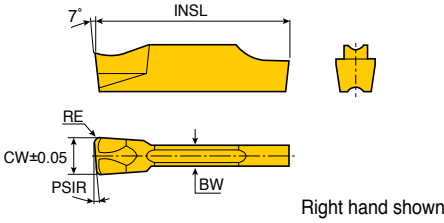

Size	Dimension (mm)				
	CW	RE	BW	INSL	PSIR
2 (.R/L)	2.0	0.20	1.7	19.8	0-15
2 RS/LS	2.0	0.02	1.7	19.6	15
3 (.R/L)	3.0	0.20	2.4	19.6	0-15
3 RS/LS	3.0	0.02	2.4	19.4	6-15
4 (.R/L)	4.0	0.30	3.0	19.7	0-15
5 (.R/L)	5.0	0.30	4.0	24.6	-
6	6.0	0.30	5.0	24.5	-

Insert	Designation	Insert seat size	Feed (mm/rev)	Cermet		Coated				Uncoated		
				CT3000		TT7505	TT6080	TT5100	TT9080	TT7220	TT8020	K10
	TSJ 2	2	0.04-0.12						●	●	●	●
	2-6R/L	2	0.03-0.08							●	●	●
	2-15R/L	2	0.03-0.08							●	●	
	2-15RS/LS	2	0.03-0.08								●	
	2-8R	2	0.03-0.07								●	
	3	3	0.04-0.16						●	●	●	●
	3-6R/L	3	0.03-0.12						●	●	●	●
	3-6RS	3	0.03-0.10						●	●	●	
	3-15R/L	3	0.03-0.12							●	●	
	3-15RS/LS	3	0.03-0.10								●	
	4	4	0.05-0.18						●	●	●	●
	4-4R/L	4	0.05-0.14							●	●	
	4-15R/L	4	0.05-0.12								●	
	5	5	0.05-0.20						●	●	●	●
	6	6	0.05-0.22						●	●	●	●

●: Standard items



TDF

Double-ended inserts for parting and grooving with UF-Type chip breaker

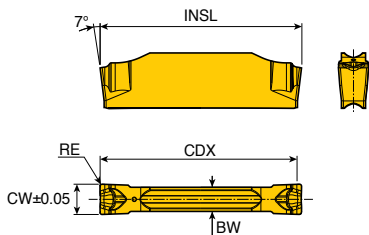

Size	Dimension (mm)				
	CW	RE	BW	INSL	CDX
2	2.0	0.2	1.5	20	19
3	3.0	0.2	2.4	20	19

Insert	Designation	Insert seat size	Feed (mm/rev)	Material							
				Cermet		Coated				Uncoated	
				CT3000	TT7505	TT6080	TT5100	TT9080	TT7220	TT8020	K10
	TDF 2	2	0.03-0.11					●			
	3	3	0.04-0.13					●			



● Standard items

TDV

Double-ended inserts for parting and grooving with V-Type chip breaker

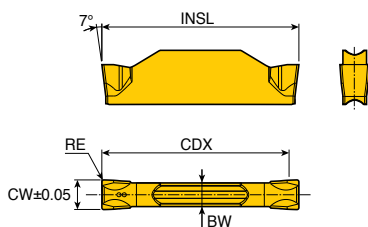

Size	Dimension (mm)				
	CW	RE	BW	INSL	CDX
2	2.0	0.2	1.7	20	19
3	3.0	0.2	2.4	20	19
4	4.0	0.3	3.0	20	19

Insert	Designation	Insert seat size	Feed (mm/rev)	Material							
				Cermet		Coated				Uncoated	
				CT3000	TT7505	TT6080	TT5100	TT9080	TT7220	TT8020	K10
	TDV 2	2	0.04-0.12					●	●		
	3	3	0.06-0.18					●	●		
	4	4	0.08-0.20					●	●		



● Standard items

Double-ended inserts for grooving, turning, face grooving and parting

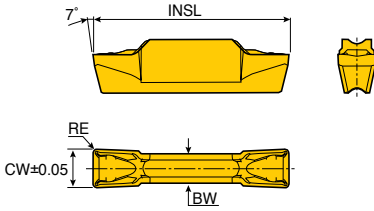

Size	Dimension (mm)			
	CW	RE	BW	INSL
2E-0.3	2.0	0.3	1.7	20.0
3E-0.3	3.0	0.3	2.2	20.0
4E-0.4	4.0	0.4	3.0	20.0
4E-0.8	4.0	0.8	3.0	20.0
5E-0.4	5.0	0.4	4.0	25.0
5E-0.8	5.0	0.8	4.0	25.0
6E-0.4	6.0	0.4	5.0	25.0
6E-0.8	6.0	0.8	5.0	25.0
8E-0.8	8.0	0.8	6.0	30.0

Insert	Designation	Insert seat size	Turning		Grooving	Cermet							Coated		Uncoated	
			ap (mm)	Feed (mm/rev)	Feed (mm/rev)	CT3000	TT7505	TT6080	TT3010	TT5100	TT9080	TT7220	TT8020	K10		
	TDXU 2E-0.3	2	0.4-1.2	0.12-0.18	0.03-0.20	●	●	●	●	●	●	●	●	●	●	●
	3E-0.3	3	0.4-1.8	0.15-0.19	0.07-0.22	●	●	●	●	●	●	●	●	●	●	●
	4E-0.4	4	0.5-2.4	0.18-0.24	0.08-0.27	●	●	●	●	●	●	●	●	●	●	●
	4E-0.8	4	1.0-2.4	0.18-0.24	0.08-0.27	●	●	●	●	●	●	●	●	●	●	●
	5E-0.4	5	0.5-3.0	0.20-0.30	0.10-0.30	●	●	●	●	●	●	●	●	●	●	●
	5E-0.8	5	1.0-3.0	0.23-0.35	0.10-0.30	●	●	●	●	●	●	●	●	●	●	●
	6E-0.4	6	0.5-3.6	0.22-0.36	0.13-0.40	●	●	●	●	●	●	●	●	●	●	●
	6E-0.8	6	1.0-3.6	0.24-0.42	0.13-0.40	●	●	●	●	●	●	●	●	●	●	●
8E-0.8	8	1.0-4.8	0.30-0.56	0.14-0.50	●	●	●	●	●	●	●	●	●	●	●	



●: Standard items

TDXT

Double-ended inserts for grooving, turning and face grooving

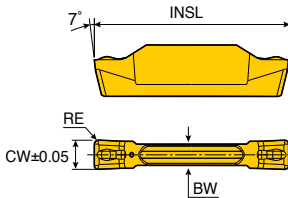

Size	Dimension (mm)			
	CW	RE	BW	INSL
3E-0.4	3.0	0.4	2.2	20.0
4E-0.4	4.0	0.4	3.0	20.0
5E-0.4	5.0	0.4	4.0	25.0
6E-0.8	6.0	0.8	5.0	25.0
8E-0.8	8.0	0.8	6.0	30.0

Insert	Designation	Insert seat size	Turning		Grooving	Cermet							Coated		Uncoated	
			ap (mm)	Feed (mm/rev)	Feed (mm/rev)	CT3000	TT7505	TT6080	TT5100	TT9080	TT7220	TT8020	K10			
	TDXT 3E-0.4	3	0.5-1.8	0.15-0.22	0.06-0.15	●	●	●	●	●	●	●	●	●	●	●
	4E-0.4	4	0.5-2.4	0.18-0.30	0.07-0.20	●	●	●	●	●	●	●	●	●	●	●
	5E-0.4	5	0.5-3.0	0.20-0.35	0.08-0.23	●	●	●	●	●	●	●	●	●	●	●
	6E-0.8	6	1.0-3.6	0.24-0.42	0.12-0.30	●	●	●	●	●	●	●	●	●	●	●
	8E-0.8	8	1.0-4.8	0.30-0.56	0.15-0.35	●	●	●	●	●	●	●	●	●	●	●



● Non-standard grade production available at the customer's request

●: Standard items

Precision double-ended inserts for external grooving only

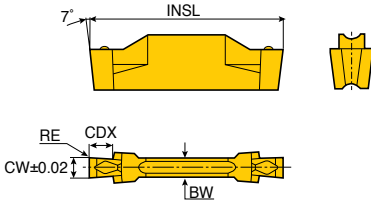

Size	Dimension (mm)				
	CW	RE	BW	INSL	CDX
1.00	1.00	0.00	2.2	20.0	2.5
1.30	1.30	0.00	2.2	20.0	2.5
1.60	1.60	0.10	2.2	20.0	2.5
1.85	1.85	0.10	2.2	20.0	3.5
2.15	2.15	0.15	2.2	20.0	3.5

Insert	Designation	Insert seat size	Grooving	Cermet	Coated					Uncoated	
			Feed (mm/rev)	CT3000	TT7505	TT6080	TT5100	TT9080	TT7220	TT8020	K10
	TDT 1.00-0.00*	2	0.02-0.04					●	●	●	
	1.30-0.00*	2	0.02-0.05					●	●	●	
	1.60-0.10*	2	0.03-0.07					●	●	●	
	1.85-0.10*	2	0.03-0.09					●	●	●	
	2.15-0.15	2	0.03-0.10					●	●	●	

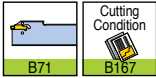

*: Only for grooving. Please use TGFR/L ...-4 holder

●: Standard items

TDT-E

Double-ended inserts for turning and grooving

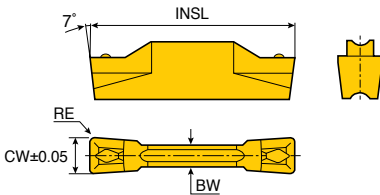

Size	Dimension (mm)			
	CW	RE	BW	INSL
3	3.0	0.4	2.2	20.0
4	4.0	0.4	3.0	20.0
6	6.0	0.8	5.0	25.0

Insert	Designation	Insert seat size	Turning	Grooving	Cermet	Ceramic	Coated					Uncoated		
			ap (mm)	Feed (mm/rev)	Feed (mm/rev)	CT3000	AB30	TT7505	TT6080	TT5100	TT9080	TT7220	TT8020	K10
	TDT 3E-0.4	3	0.5-1.8	0.15-0.22	0.07-0.15	●		●	●	●	●	●	●	●
	4E-0.4	4	0.5-2.4	0.18-0.30	0.09-0.18	●		●	●	●	●	●	●	●
	4E-0.4T CE⁽¹⁾	4	0.5-2.4	0.18-0.30	0.09-0.35		●							
	6E-0.8T CE⁽¹⁾	6	1.0-3.6	0.24-0.42	0.13-0.40		●							



⁽¹⁾This insert is a pressed ceramic insert

●: Standard items

Precision double-ended inserts for turning and grooving

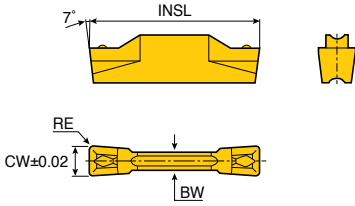

Size	Dimension (mm)			
	CW	RE	BW	INSL
2.65 / 3.00 / 3.15	2.65-3.15	0.15-0.40	2.2	20.0
4.00 / 4.15	4.00-4.15	0.15-0.80	3.0	20.0
4.78 / 5.00 / 5.15	4.78-5.15	0.15-0.80	4.0	25.0
6.00	6.00	0.80-1.20	5.0	25.0
8.00	8.00	0.80-1.20	6.0	30.0
10.00	10.00	0.80-2.00	8.0	30.0

Insert	Designation	Insert seat size	Turning		Grooving	Cermet						Coated		Uncoated
			ap (mm)	Feed (mm/rev)	Feed (mm/rev)	CT3000	TT7505	TT6080	TT5100	TT9080	TT7220	TT8020	K10	
	TDT 2.65E-0.15	3	0.2-1.8	0.10-0.18	0.05-0.12			●	●	●	●		●	
	3.00E-0.20	3	0.3-2.0	0.12-0.20	0.07-0.13			●	●	●	●		●	
	3.00E-0.40	3	0.5-2.0	0.15-0.22	0.07-0.15			●	●	●	●		●	
	3.15E-0.15	3	0.2-2.0	0.15-0.22	0.07-0.15			●	●	●	●		●	
	4.00E-0.40	4	0.5-2.4	0.18-0.30	0.09-0.18			●	●	●	●		●	
	4.00E-0.80	4	1.0-2.4	0.18-0.30	0.09-0.18			●	●	●	●	●	●	
	4.15E-0.15	4	0.5-2.4	0.18-0.30	0.09-0.18			●	●					
	4.78E-0.55	5	0.7-2.8	0.20-0.35	0.10-0.20			●	●	●				
	5.00E-0.40	5	0.5-2.3	0.20-0.35	0.11-0.20			●	●	●	●		●	
	5.00E-0.80	5	1.0-3.0	0.23-0.35	0.11-0.21			●	●	●	●		●	
	5.15E-0.15	5	0.2-3.0	0.23-0.35	0.11-0.21			●	●					
	6.00E-0.80	6	1.0-3.6	0.24-0.42	0.13-0.30			●	●	●	●		●	
	6.00E-1.20	6	1.3-3.6	0.24-0.42	0.13-0.30			●	●	●	●		●	
	8.00E-0.80	8	1.0-4.8	0.30-0.56	0.15-0.40			●	●	●	●		●	
	8.00E-1.20	8	1.3-4.8	0.30-0.56	0.15-0.40			●	●	●	●		●	
	10.00E-0.80	10	1.0-6.0	0.35-0.65	0.20-0.45			●	●					
10.00E-1.20	10	1.0-6.0	0.40-0.80	0.20-0.45			●	●						
10.00E-2.00	10	1.0-6.0	0.35-0.80	0.20-0.45			●	●						



●: Standard items

TDT-E (Full-Radius)

Precision double-ended inserts for external turning, grooving and profiling

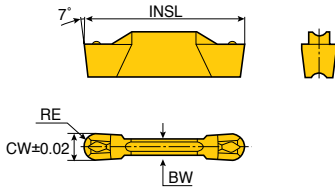

Size	Dimension (mm)			
	CW	RE	BW	INSL
3	3.00	1.50	2.2	20.0
4	4.00	2.00	3.0	20.0
4.78	4.78	2.39	4.0	25.0
5	5.00	2.50	4.0	25.0
6	6.00	3.00	5.0	25.0
8	8.00	4.00	6.0	30.0
10	10.00	5.00	8.0	30.0

Insert	Designation	Insert seat size	Turning		Grooving	Cermet		Coated			Uncoated	
			ap (mm)	Feed (mm/rev)	Feed (mm/rev)	CT3000	TT7505	TT6080	TT15100	TT9080	TT7220	TT8020
	TDT 3.00E-1.50	3	0.0-1.5	0.15-0.28	0.08-0.18			●	●	●	●	
	4.00E-2.00	4	0.0-2.0	0.18-0.35	0.10-0.20			●	●	●	●	
	4.78E-2.39	5	0.0-2.4	0.20-0.42	0.12-0.23			●	●	●		
	5.00E-2.50	5	0.0-2.5	0.20-0.42	0.12-0.23			●	●	●		●
	6.00E-3.00	6	0.0-3.0	0.25-0.54	0.15-0.27			●	●	●		●
	8.00E-4.00	8	0.0-4.0	0.30-0.67	0.18-0.35			●	●	●		
	10.00E-5.00	10	0.0-5.0	0.35-0.80	0.22-0.40			●	●			



●: Standard items

TDT-RS (Full-Radius)

Precision double-ended inserts for external turning, grooving and profiling

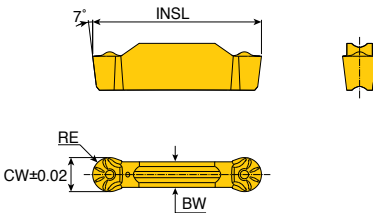

Size	Dimension (mm)			
	CW	RE	BW	INSL
2	2.0	1.0	1.7	20.0
3	3.0	1.5	2.4	20.0
4	4.0	2.0	3.0	20.0
5	5.0	2.5	4.0	25.0
6	6.0	3.0	5.0	25.0

Insert	Designation	Insert seat size	Turning		Grooving	Cermet		Coated			Uncoated	
			ap (mm)	Feed (mm/rev)	Feed (mm/rev)	CT3000	TT7505	TT6080	TT15100	TT3010	TT9080	TT7220
	TDT 2.00E-1.00-RS	2	0.0-1.0	0.10-0.22	0.08-0.15							●
	3.00E-1.50-RS	3	0.0-1.5	0.15-0.28	0.09-0.18				●	●		●
	4.00E-2.00-RS	4	0.0-2.0	0.18-0.35	0.10-0.20				●	●		●
	5.00E-2.50-RS	5	0.0-2.5	0.25-0.54	0.13-0.23				●	●		●
	6.00E-3.00-RS	6	0.0-3.0	0.30-0.67	0.15-0.27				●	●		●



●: Standard items

TDT-RU (Full-Radius)

Double-ended inserts for external turning, grooving and profiling

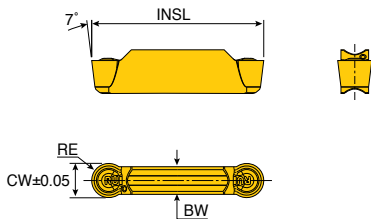

Size	Dimension (mm)			
	CW	RE	BW	INSL
2	2.0	1.0	1.7	20.0
3	3.0	1.5	2.2	20.0
4	4.0	2.0	3.0	20.0
5	5.0	2.5	4.0	25.0
6	6.0	3.0	5.0	25.0
8	8.0	4.0	6.0	30.0

Insert	Designation	Insert seat size	Turning		Grooving	Cermet		Coated				Uncoated	
			ap (mm)	Feed (mm/rev)	Feed (mm/rev)	CT3000	TT7505	TT6080	TT15100	TT3010	TT9080	TT7220	TT8020
	TDT 2E-1.0-RU	2	0.0-1.0	0.10-0.25	0.05-0.15			●	●	●	●	●	●
	3E-1.5-RU	3	0.0-1.5	0.15-0.28	0.08-0.18	●		●	●	●	●	●	●
	4E-2.0-RU	4	0.0-2.0	0.18-0.35	0.10-0.20	●		●	●	●	●	●	●
	5E-2.5-RU	5	0.0-2.5	0.20-0.42	0.12-0.23	●		●	●	●	●	●	●
	6E-3.0-RU	6	0.0-3.0	0.25-0.54	0.15-0.27	●		●	●	●	●	●	●
	8E-4.0-RU	8	0.0-4.0	0.30-0.67	0.18-0.35			●	●	●	●	●	●



●: Standard items

TDFT-E

Double-ended inserts for face grooving

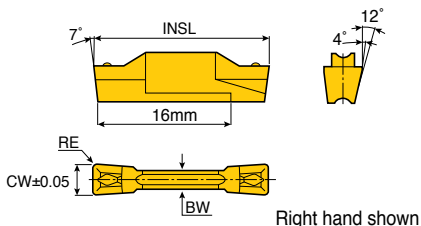

Size	Dimension (mm)			
	CW	RE	BW	INSL
3E	3.0	0.40	2.2	20.0
4E	4.0	0.40	3.0	20.0

Insert	Designation	Insert seat size	Turning		Grooving	Cermet		Coated				Uncoated
			ap (mm)	Feed (mm/rev)	Feed (mm/rev)	CT3000	TT7505	TT6080	TT15100	TT9080	TT7220	TT8020
	TDFT 3E-0.4R/L	3	0.5-2.0	0.15-0.22	0.07-0.15				●	●		●
	4E-0.4R/L	4	0.5-2.4	0.18-0.30	0.09-0.18				●	●		●



● Apply R insert on R tool and L insert on L tool

●: Standard items

Precision double-ended inserts for internal turning and grooving

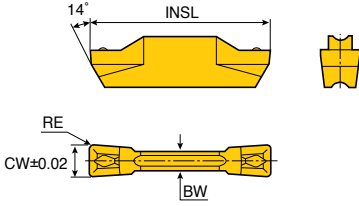

Size	Dimension (mm)			
	CW	RE	BW	INSL
3	3.00	0.40	2.2	20.0
4	4.00	0.40-0.80	3.0	20.0
5	5.00	0.40-0.80	4.0	25.0
6	6.00	0.80-1.20	5.0	25.0
8	8.00	1.20	6.0	30.0

Insert	Designation	Insert seat size	Turning		Grooving	Cermet	Coated					Uncoated
			ap (mm)	Feed (mm/rev)	Feed (mm/rev)		CT3000	TT7505	TT6080	TT5100	TT9080	
	TDIT 3.00E-0.40	3	0.5-1.8	0.15-0.22	0.07-0.15				●	●		●
	4.00E-0.40	4	0.5-2.4	0.18-0.30	0.09-0.18				●	●		●
	4.00E-0.80	4	1.0-2.4	0.18-0.30	0.09-0.18				●	●		●
	5.00E-0.40	5	0.5-2.3	0.20-0.35	0.11-0.20				●	●		●
	5.00E-0.80	5	1.0-3.0	0.23-0.35	0.11-0.21				●	●		●
	6.00E-0.80	6	1.0-3.6	0.24-0.42	0.13-0.30				●	●		●
	6.00E-1.20	6	1.3-3.6	0.24-0.42	0.13-0.30				●	●		●
	8.00E-0.80	8	1.0-4.8	0.30-0.56	0.15-0.40				●	●		●
	8.00E-1.20	8	1.3-4.8	0.30-0.56	0.15-0.40				●	●		●



●: Standard items

TDIT-E (Full-Radius)

Precision double-ended inserts for internal turning, grooving, profiling and undercutting

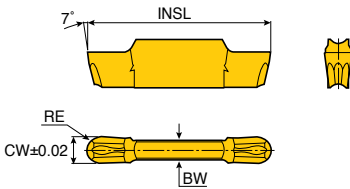

Size	Dimension (mm)			
	CW	RE	BW	INSL
3	3.00	1.50	2.2	20.0
4	4.00	2.00	3.0	20.0
5	5.00	2.50	4.0	25.0
6	6.00	3.00	5.0	25.0

Insert	Designation	Insert seat size	Turning		Grooving	Cermet	Coated					Uncoated
			ap (mm)	Feed (mm/rev)	Feed (mm/rev)		CT3000	TT7505	TT6080	TT5100	TT9080	
	TDIT 3.00E-1.50	3	0.0-1.5	0.15-0.28	0.08-0.18				●	●		●
	4.00E-2.00	4	0.0-2.0	0.18-0.35	0.10-0.20				●	●		●
	5.00E-2.50	5	0.0-2.5	0.20-0.42	0.12-0.23				●	●		●
	6.00E-3.00	6	0.0-3.0	0.25-0.54	0.15-0.27				●	●		●



●: Standard items

Double-ended inserts for internal turning and grooving on small diameter

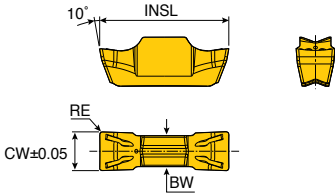

Size	Dimension (mm)			
	CW	RE	BW	INSL
2	2.0	0.15	1.6	10
3	3.0	0.20	2.4	10

Insert	Designation	Insert seat size	Turning		Grooving	Cermet	Coated				Uncoated	
			ap (mm)	Feed (mm/rev)	Feed (mm/rev)	CT3000	TT7505	TT6080	TT5100	TT9080	TT7220	TT8020
	TDIM 2E-0.15	2	0.2-0.6	0.05-0.08	0.03-0.05					●		
	3E-0.2	3	0.3-1.3	0.10-0.14	0.05-0.09					●		

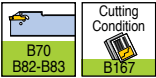

• Used holder TTSER/L, TTSIR/L, TGSIR/L

●: Standard items

TDIP

Precision double-ended inserts for internal turning and grooving on small diameter

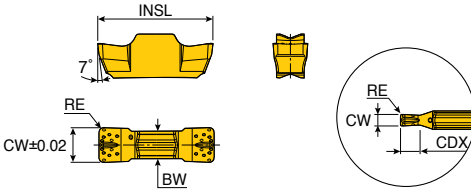

Size	Dimension (mm)				
	CW	RE	BW	INSL	CDX
1.00	1.00	0.10-0.50	1.6	10	1.6
1.20	1.20	0.00	1.6	10	1.8
1.40	1.40	0.00	1.6	10	2.0
1.50	1.50	0.10	1.6	10	2.0
2.00	2.00	0.10-1.00	1.6	10	-
2.15	2.15	0.15	1.6	10	-
2.50	2.50	0.20	2.4	10	-
3.00	3.00	0.20-1.50	2.4	10	-

Insert	Designation	Insert seat size	Turning		Grooving	Cermet	Coated				Uncoated	
			ap (mm)	Feed (mm/rev)	Feed (mm/rev)	CT3000	TT7505	TT6080	TT5100	TT9080	TT7220	TT8020
	TDIP 1.00-0.10*	2	-	-	0.01-0.03					●		
	1.00-0.50*	2	-	-	0.01-0.04					●		
	1.20-0.00*	2	-	-	0.01-0.03					●		
	1.40-0.00*	2	-	-	0.02-0.04					●		
	1.50-0.10*	2	-	-	0.02-0.04					●		
	2.00E-0.10	2	0.2-0.6	0.05-0.07	0.03-0.05					●		
	2.00E-0.20	2	0.2-0.6	0.05-0.07	0.03-0.05					●		
	2.00E-1.00	2	0.0-0.6	0.08-0.12	0.04-0.07					●		
	2.15E-0.15	2	0.2-0.6	0.06-0.08	0.04-0.06					●		
	2.50E-0.20	3	0.2-1.1	0.07-0.09	0.04-0.07					●		
	3.00E-0.20	3	0.3-1.3	0.11-0.14	0.05-0.09					●		
3.00E-1.50	3	0.0-1.5	0.13-0.20	0.05-0.11					●			

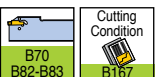

• * Only for grooving: Please use TGSIR/L holder

●: Standard items

Inserts for aluminum wheel machining

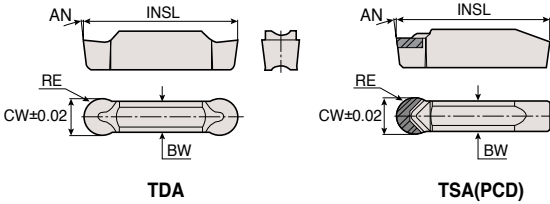

Size	Dimension (mm)				
	CW	RE	BW	INSL	AN
3	3.00	1.5	2.4	20.0	7
4	4.00	2.0	3.0	20.0	7
5	5.00	2.5	4.0	25.0	7
6	6.00	3.0	5.0	25.0	7
8	8.00	4.0	6.0	30.0	10

Insert	Designation	Insert seat size	Turning		Grooving	PCD		Coated				Uncoated	
			ap (mm)	Feed (mm/rev)	Feed (mm/rev)	KP300	TT7505	TT6080	TT15100	TT9080	TT7220	TT8020	K10
 TDA	TDA 3.00-1.50	3	0.0-1.5	0.15-0.30	0.08-0.16								●
	4.00-2.00	4	0.0-2.0	0.20-0.43	0.10-0.22								●
	5.00-2.50	5	0.0-2.5	0.20-0.48	0.10-0.25								●
	6.00-3.00	6	0.0-3.0	0.21-0.58	0.11-0.29								●
	8.00-4.00	8	0.0-4.0	0.24-0.67	0.14-0.38								●
 TSA	TSA 6.00-3.00	6	0.0-3.0	0.26-0.72	0.13-0.36	●							
	8.00-4.00	8	0.0-4.0	0.24-0.67	0.14-0.38	●							



● : Standard items

TSG-HF

Single-ended CBN inserts for high feed turning

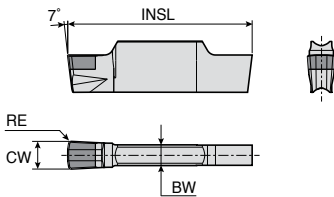

Size	Dimension (mm)					
	CW	RE	BW	INSL		
3	3.0	0.3	2.2	20		
5	5.0	0.3	4.0	25		

Insert	Designation	Insert seat size	ap (mm)	Feed (mm/rev)	CBN
					TB2015
	TSG 3.0-0.3-HF	3	0.08-0.12	0.40-0.80	●
	5.0-0.3-HF	5	0.08-0.12	0.40-1.20	●



● : Standard items

Double-ended inserts for face grooving and turning

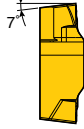
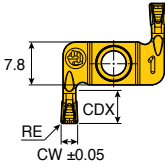
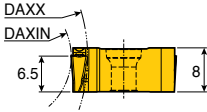

Right hand shown

Size	Dimension (mm)				
	CW	RE	CDX	DAXIN	DAXX
3	3	0.3	6	24	N.L.
4	4	0.4	6	32	N.L.

Insert	Designation	Turning		Grooving	Cermet		Coated				Uncoated	
		ap (mm)	Feed (mm/rev)	Feed (mm/rev)	CT3000	TT7505	TT6080	TT5100	TT9080	TT7220	TT8020	K10
	TDFX 3E-0.3-D24R/L	0.4-1.8	0.15-0.20	0.07-0.20					●			
	4E-0.4-D32R/L	0.5-2.4	0.15-0.24	0.09-0.25					●			

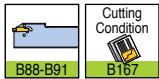

● N.L.: No limit

●: Standard items

TDX

Double-ended threading inserts with 60° partial profile

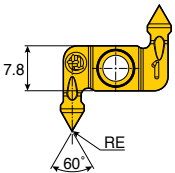

Right hand shown

Size	Dimension (mm)				
	RE	TPN	TPX	TPIX	TPIN
4	0.05	0.45	3.5	56	8

Insert	Designation	Cermet		Coated				Uncoated	
		CT3000	TT7505	TT6080	TT5100	TT9080	TT7220	TT8020	K10
	TDX 4MT-0.05-R/L					●			



- TPN : Thread pitch minimum (mm)
- TPX : Thread pitch maximum (mm)
- TPIX : Thread per inch maximum
- TPIN : Thread per inch minimum

●: Standard items

MIN	T	R	04	040	005	D010
1	7	2	3	4	5	6

1 TOP-MICRO series

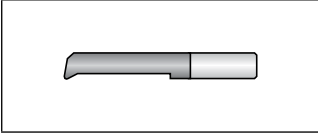

2 Hand of tool

R Right-hand
L Left-hand

3 Shank dia.

04 4.0mm
07 7.0mm

4 Max. depth

050 5.0mm
140 14.0mm

5 Corner radius

010 0.10mm
020 0.20mm

6 Min. bore dia.

D010 1.0mm

7 Application type

T	Turning and chamfering
B	Back turning
P	Turning and profiling
U	Undercutting and chamfering
C	Turning and 45° chamfering
G	Grooving and turning
S	Grooving along shaft
F	Face grooving
R	Full radius for internal boring and profiling
I	ISO full profile internal threading
SL	Sleeve for MINS

Sleeves for direct connection for coolant

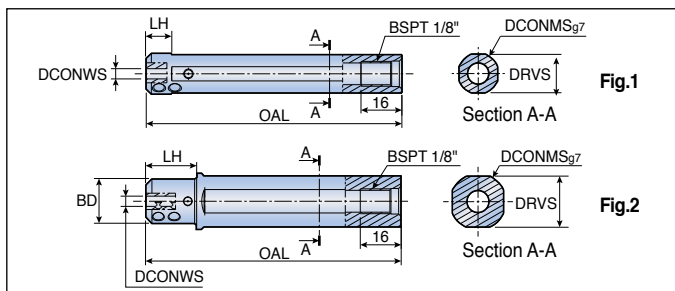

Designation	Dimension (mm)						Fig.
	DCONMS	DCONWS	BD	OAL	LH	DRVS	
MINS 16-4-L100C	16.00	4.00	-	100.00	10.00	15.00	1
16-7-L100C	16.00	7.00	-	100.00	10.00	15.00	1
20-4-L100C	20.00	4.00	17.50	100.00	20.00	18.00	2
20-7-L100C	20.00	7.00	17.50	100.00	20.00	18.00	2
22-4-L100C	22.00	4.00	17.50	100.00	20.00	20.00	2
22-7-L100C	22.00	7.00	17.50	100.00	20.00	20.00	2
25-4-L100C	25.00	4.00	18.00	100.00	23.00	23.00	2
25-7-L100C	25.00	7.00	18.00	100.00	23.00	23.00	2

• All sleeves applicable for Citizen Swiss type machine

Spare parts

Designation	Set screw	Wrench		
MINS ...-L100C	SS M5x0.8x6-MG	L-W 2.5		

Mini carbide bars for internal turning and chamfering

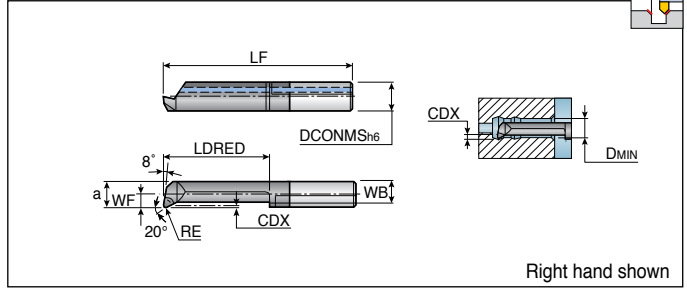

Designation	Dimension (mm)									R/L	Grade TT9030
	DCONMS	WF	a	WB	LF	LDRED	RE	CDX	DMIN		
MINTR07-090015D050	7.00	0.90	4.40	3.65	25.00	10.00	0.15	0.50	5.00	R	●
140015D050	7.00	0.90	4.40	3.65	30.00	15.00	0.15	0.50	5.00	R	●
190015D050	7.00	0.90	4.40	3.65	35.00	20.00	0.15	0.50	5.00	R	●
240015D050	7.00	0.90	4.40	3.65	40.00	25.00	0.15	0.50	5.00	R	●
290015D050	7.00	0.90	4.40	3.65	45.00	30.00	0.15	0.50	5.00	R	●
340015D050	7.00	0.90	4.40	3.65	50.00	35.00	0.15	0.50	5.00	R	●
140015D060	7.00	1.80	5.30	4.40	30.00	15.00	0.15	0.50	6.00	R	●
210015D060	7.00	1.80	5.30	4.40	37.00	22.00	0.15	0.50	6.00	R	●
240015D060	7.00	1.80	5.30	4.40	40.00	25.00	0.15	0.50	6.00	R	●
290015D060	7.00	1.80	5.30	4.40	45.00	30.00	0.15	0.50	6.00	R	●
340015D060	7.00	1.80	5.30	4.40	50.00	35.00	0.15	0.50	6.00	R	●
410015D060	7.00	1.80	5.30	4.40	57.00	42.00	0.15	0.50	6.00	R	●
190015D068	7.00	2.80	6.30	5.40	35.00	20.00	0.15	0.60	6.80	R	●
240015D068	7.00	2.80	6.30	5.40	40.00	25.00	0.15	0.60	6.80	R	●
290015D068	7.00	2.80	6.30	5.40	45.00	30.00	0.15	0.60	6.80	R	●
340015D070	7.00	2.80	6.30	5.40	50.00	35.00	0.15	0.60	7.00	R	●
390015D070	7.00	2.80	6.30	5.40	55.00	40.00	0.15	0.60	7.00	R	●
440015D070	7.00	2.80	6.30	5.40	60.00	45.00	0.15	0.60	7.00	R	●
490015D070	7.00	2.80	6.30	5.40	65.00	50.00	0.15	0.60	7.00	R	●
MINTL07-090015D050	7.00	0.90	4.40	3.65	25.00	10.00	0.15	0.50	5.00	L	●
140015D050	7.00	0.90	4.40	3.65	30.00	15.00	0.15	0.50	5.00	L	●
190015D050	7.00	0.90	4.40	3.65	35.00	20.00	0.15	0.50	5.00	L	●
240015D050	7.00	0.90	4.40	3.65	40.00	25.00	0.15	0.50	5.00	L	●
290015D050	7.00	0.90	4.40	3.65	45.00	30.00	0.15	0.50	5.00	L	●
140015D060	7.00	1.80	5.30	4.40	30.00	15.00	0.15	0.50	6.00	L	●
210015D060	7.00	1.80	5.30	4.40	37.00	22.00	0.15	0.50	6.00	L	●
240015D060	7.00	1.80	5.30	4.40	40.00	25.00	0.15	0.50	6.00	L	●
290015D060	7.00	1.80	5.30	4.40	45.00	30.00	0.15	0.50	6.00	L	●
190015D068	7.00	2.80	6.30	5.40	35.00	20.00	0.15	0.60	6.80	L	●
290015D068	7.00	2.80	6.30	5.40	45.00	30.00	0.15	0.60	6.80	L	●
340015D070	7.00	2.80	6.30	5.40	50.00	35.00	0.15	0.60	7.00	L	●

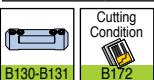

●: Standard items

MINP R 04/07



Mini carbide bars for internal turning and profiling

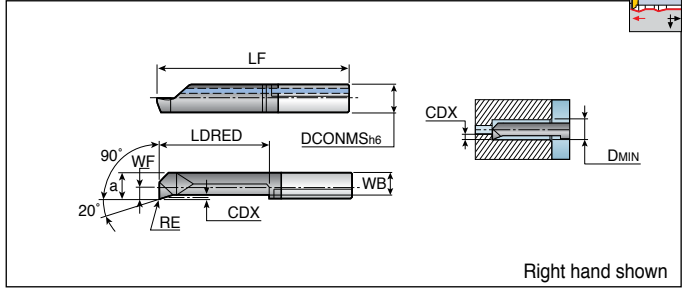

Designation	Dimension (mm)									R/L	Grade TT9030
	DCONMS	WF	a	WB	LF	LDRED	RE	CDX	DMIN		
MINPR04-090010D028	4.00	0.90	2.60	2.20	25.50	10.50	0.10	0.20	2.80	R	●
150010D028	4.00	0.90	2.60	2.20	31.50	16.50	0.10	0.20	2.80	R	●
090010D040	4.00	1.50	3.50	2.90	25.50	10.50	0.10	0.30	4.00	R	●
150010D040	4.00	1.50	3.50	2.90	31.50	16.50	0.10	0.30	4.00	R	●
MINPR07-140015D050	7.00	0.90	4.40	3.65	30.00	15.00	0.15	0.50	5.00	R	●
190015D050	7.00	0.90	4.40	3.65	35.00	20.00	0.15	0.50	5.00	R	●

●: Standard items

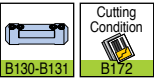

MINC R 07



Mini carbide bars for internal turning and 45° chamfering

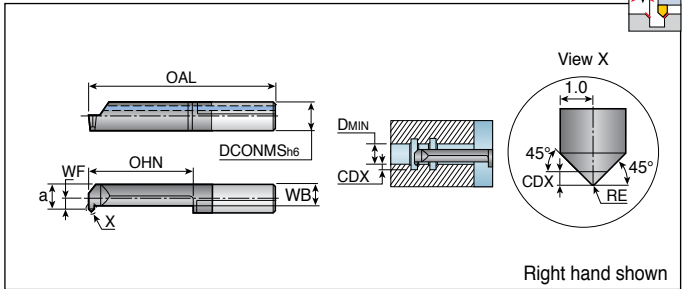

Designation	Dimension (mm)									R/L	Grade TT9030
	DCONMS	WF	a	WB	OAL	OHN	RE	CDX	DMIN		
MINCR07-140020D050	7.00	0.90	4.40	3.20	30.00	15.00	0.20	0.70	5.00	R	●
190020D050	7.00	0.90	4.40	3.20	35.00	20.00	0.20	0.70	5.00	R	●
190020D068	7.00	2.80	6.30	3.80	35.00	20.00	0.20	0.70	6.80	R	●

●: Standard items

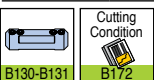

MING R/L 07



Mini carbide bars for grooving and turning

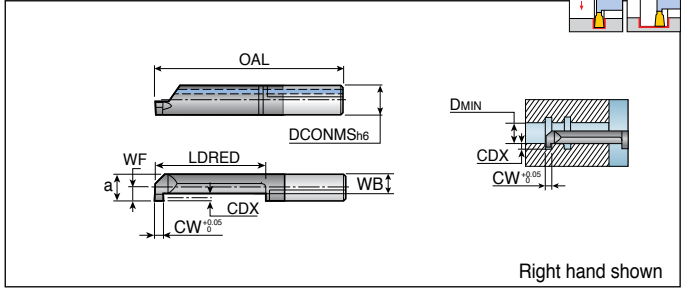

Designation	Dimension (mm)									R/L	Grade TT9030
	DCONMS	CW	WF	a	WB	OAL	LDRED	CDX	DMIN		
MINGR07- 090100D050	7.00	1.00	0.90	4.40	3.00	25.00	10.00	1.00	5.00	R	●
140100D050	7.00	1.00	0.90	4.40	3.00	30.00	15.00	1.00	5.00	R	●
090150D050	7.00	1.50	0.90	4.40	3.00	25.00	10.00	1.00	5.00	R	●
140150D050	7.00	1.50	0.90	4.40	3.00	30.00	15.00	1.00	5.00	R	●
090200D050	7.00	2.00	0.90	4.40	3.00	25.00	10.00	1.00	5.00	R	●
190200D050	7.00	2.00	0.90	4.40	3.00	35.00	20.00	1.00	5.00	R	●
090100D060	7.00	1.00	1.80	5.30	3.10	25.00	10.00	1.80	6.00	R	●
140100D060	7.00	1.00	1.80	5.30	3.10	30.00	15.00	1.80	6.00	R	●
210100D060	7.00	1.00	1.80	5.30	3.10	37.00	22.00	1.80	6.00	R	●
290100D060	7.00	1.00	1.80	5.30	3.10	45.00	30.00	1.80	6.00	R	●
090150D060	7.00	1.50	1.80	5.30	3.10	25.00	10.00	1.80	6.00	R	●
140150D060	7.00	1.50	1.80	5.30	3.10	30.00	15.00	1.80	6.00	R	●
210150D060	7.00	1.50	1.80	5.30	3.10	37.00	22.00	1.80	6.00	R	●
240150D060	7.00	1.50	1.80	5.30	3.10	40.00	25.00	1.80	6.00	R	●
290150D060	7.00	1.50	1.80	5.30	3.10	45.00	30.00	1.80	6.00	R	●
090200D060	7.00	2.00	1.80	5.30	3.10	25.00	10.00	1.80	6.00	R	●
140200D060	7.00	2.00	1.80	5.30	3.10	30.00	15.00	1.80	6.00	R	●
210200D060	7.00	2.00	1.80	5.30	3.10	37.00	22.00	1.80	6.00	R	●
240200D060	7.00	2.00	1.80	5.30	3.10	40.00	25.00	1.80	6.00	R	●
290200D060	7.00	2.00	1.80	5.30	3.10	45.00	30.00	1.80	6.00	R	●
090100D068	7.00	1.00	2.70	6.20	3.30	25.00	10.00	2.50	6.80	R	●
140100D068	7.00	1.00	2.70	6.20	3.30	30.00	15.00	2.50	6.80	R	●
210100D068	7.00	1.00	2.70	6.20	3.30	37.00	22.00	2.50	6.80	R	●
090150D068	7.00	1.50	2.70	6.20	3.30	25.00	10.00	2.50	6.80	R	●
140150D068	7.00	1.50	2.70	6.20	3.30	30.00	15.00	2.50	6.80	R	●
210150D068	7.00	1.50	2.70	6.20	3.30	37.00	22.00	2.50	6.80	R	●
290150D068	7.00	1.50	2.70	6.20	3.30	45.00	30.00	2.50	6.80	R	●
090200D068	7.00	2.00	2.70	6.20	3.30	25.00	10.00	2.50	6.80	R	●
140200D068	7.00	2.00	2.70	6.20	3.30	30.00	15.00	2.50	6.80	R	●
210200D068	7.00	2.00	2.70	6.20	3.30	37.00	22.00	2.50	6.80	R	●
290200D068	7.00	2.00	2.70	6.20	3.30	45.00	29.00	2.50	6.80	R	●
MINGL07- 090100D060	7.00	1.00	1.80	5.30	3.10	25.00	10.00	1.80	6.00	L	●
090150D060	7.00	1.50	1.80	5.30	3.10	25.00	10.00	1.80	6.00	L	●
140200D068	7.00	2.00	2.70	6.20	3.30	30.00	15.00	2.50	6.80	L	●

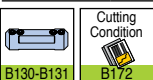

• The corner radius is less than 0.1mm

●: Standard items

MINS R 07



Mini carbide bars for grooving along shaft

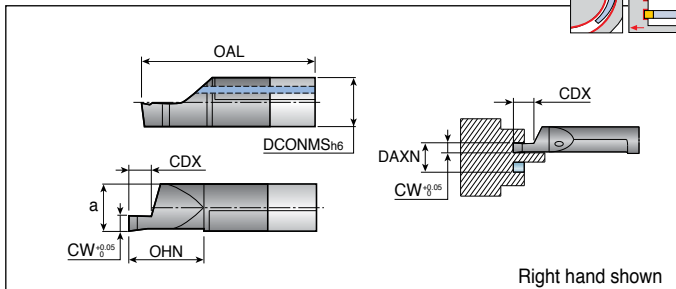

Designation	Dimension (mm)							R/L	Grade TT9030
	DCONMS	CW	a	OAL	OHN	CDX	DAXN		
MINSR07-200200D060	7.00	2.00	5.20	36.00	21.00	4.00	6.00	R	●

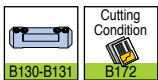

• The corner radius is less than 0.1mm

●: Standard items

MINR R 07



Mini carbide bars, full radius for internal turning and profiling

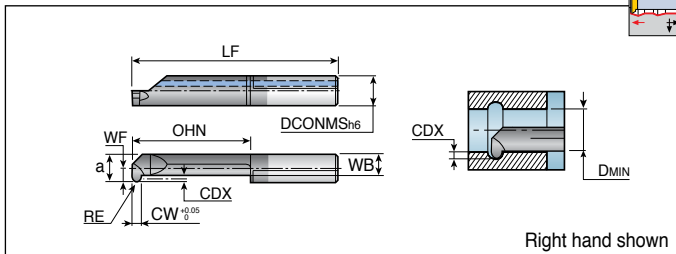

Designation	Dimension (mm)										R/L	Grade TT9030
	DCONMS	CW	WF	a	WB	RE	LF	OHN	CDX	DMIN		
MINRR07-190050D050	7.00	1.00	0.90	4.40	3.10	0.50	35.00	20.00	1.00	5.00	R	●
240050D060	7.00	1.00	1.80	5.30	3.20	0.50	40.00	25.00	1.80	6.00	R	●
290050D068	7.00	1.00	2.80	6.30	3.55	0.50	45.00	30.00	2.50	6.80	R	●

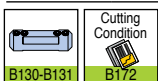

●: Standard items

TV **E** **R** **4** **07** **010** **45**
1 2 3 4 5 6 7

1 TaeguTec TOP-CUT series

2 Application type

E External turning
R Reverse turning
B Back turning
T Threading
P Parting

3 Hand of tool

R Right-hand
L Left-hand

4 Insert thickness

4 3.97mm

5 Width of insert

07 0.7mm
10 1.0mm
12 1.2mm
15 1.5mm
18 1.8mm
20 2.0mm

6 Corner radius

000 0mm
003 0.03mm
005 0.05mm
010 0.10mm
015 0.15mm

7 CDX (TVPR/L only)

45 4.5mm
50 5.0mm
60 6.0mm

General turning inserts

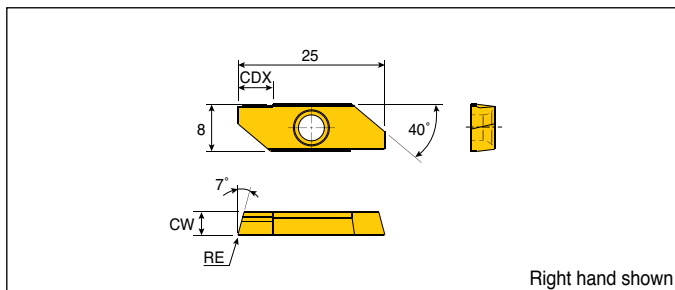

Designation	ap (mm)	Feed (mm/rev)	Dimension (mm)			Grade (TT9010)	
			CW	RE	CDX	R	L
TVER/L 40003	0.1-5.5	0.01-0.15	3.97	0.03	5.5	●	
40010	0.1-5.5	0.01-0.15	3.97	0.10	5.5	●	



●: Standard items

TVRR/L

Reverse turning inserts

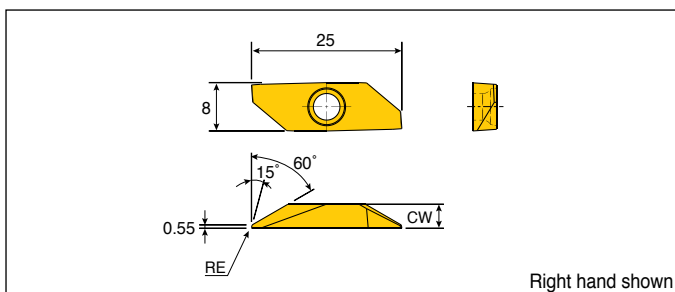

Designation	ap (mm)	Feed (mm/rev)	Dimension (mm)			Grade (TT9010)	
			CW	RE	CDX	R	L
TVRR/L 40003-60	0.1-5.5	0.01-0.15	3.97	0.03	5.5	●	
40010-60	0.1-5.5	0.01-0.15	3.97	0.10	5.5	●	



●: Standard items

Back turning inserts

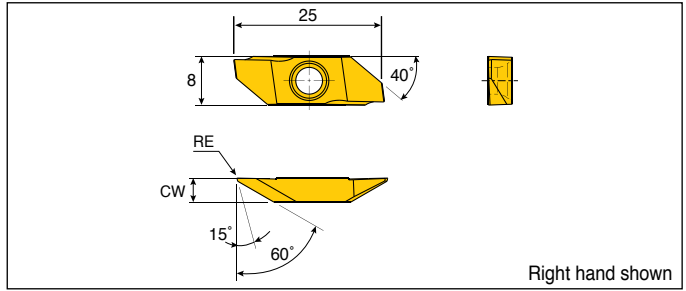

Designation	ap (mm)	Feed (mm/rev)	Dimension (mm)			Grade (TT9010)	
			CW	RE	CDX	R	L
TVBR/L 40003	0.1-5.5	0.01-0.15	3.97	0.03	5.5	●	●
40005	0.1-5.5	0.01-0.15	3.97	0.05	5.5	●	●
40010	0.1-5.5	0.01-0.15	3.97	0.10	5.5	●	●
40015	0.1-5.5	0.01-0.15	3.97	0.15	5.5	●	●
40005-H⁽¹⁾	0.1-5.5	0.01-0.15	3.97	0.05	5.5	●	●
40015-H⁽¹⁾	0.1-5.5	0.01-0.15	3.97	0.15	5.5	●	●



● ⁽¹⁾ With honed edges

●: Standard items

TVTR/L

Threading inserts

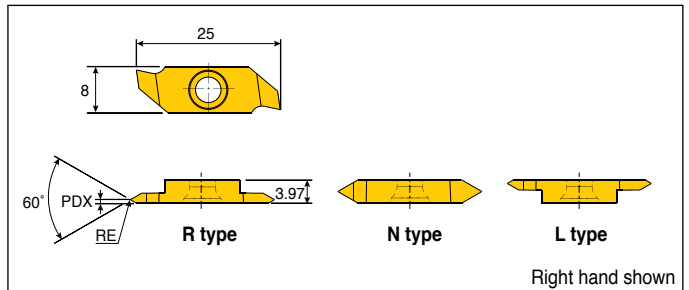

Designation	Dimension (mm)				Grade (TT9010)	
	TPN	TPX	PDX	RE	R	L
TVTR/L 41203-R	0.5	1.0	0.6	0.03	●	
40003-N	0.5	2.0	2.1	0.03	●	
41203-L	0.5	1.0	0.6	0.03		



● TVTR 41203-R/L → pitch range: 0.5 - 1.0mm

● TVTR 40003-N → pitch range: 0.5 - 2.0mm

● TPN: Thread pitch minimum (mm), TPX: Thread pitch maximum (mm)

●: Standard items

T **Q** **J** - **27** - **3** - **0.2** - **6** - **R**

1 2 3 4 5 6 7 8

1 TaeguTec

2 QUAD-RUSH

3 Chip breaker type

C	J	S
For medium	For light	For light & tailor made

4 Circular circumference of the insert

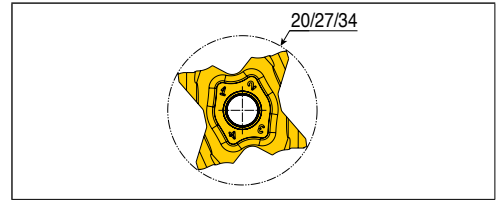

5 Width of insert

	<p>1.00 = 1.0 mm</p> <p>1.50 = 1.5 mm</p> <p>2.53 = 2.53 mm</p> <p>3.18 = 3.18 mm</p>
--	---

6 Corner radius

	<p>0.10 = 0.1 mm</p> <p>0.20 = 0.2 mm</p> <p>0.30 = 0.3 mm</p> <p>0.40 = 0.4 mm</p>
--	---

7 Lead angle

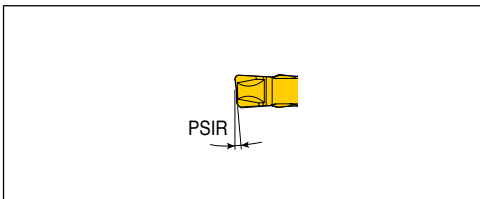

8 Hand of insert

L	R
Left-hand	Right-hand

TQJ 20



Precision grooving and parting inserts with J-Type chip breaker

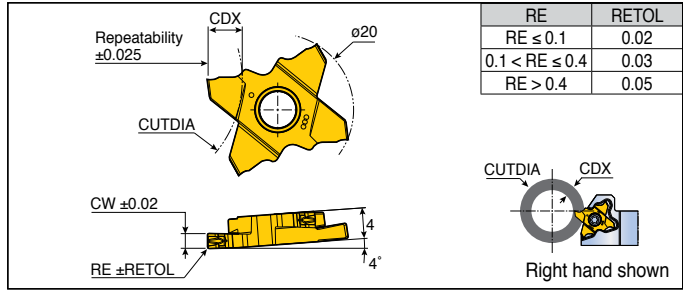

RE	RETOL
RE ≤ 0.1	0.02
0.1 < RE ≤ 0.4	0.03
RE > 0.4	0.05

Designation	Feed (mm/rev)	CW	RE	CDX	CUTDIA					Grade
					CDX ≤ 2.7	CDX ≤ 3.5	CDX ≤ 4.0	CDX ≤ 4.5	CDX ≤ 5.0	
TQJ 20-1.00-0.10-R/L	0.03-0.07	1.00	0.10	2.7	N.L.	-	-	-	-	●
20-1.50-0.20-R/L	0.03-0.08	1.50	0.20	5.0	N.L.	70	50	30	16	●
20-2.00-0.20-R/L	0.04-0.10	2.00	0.20	5.0	N.L.	70	50	30	16	●

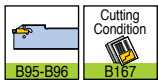

• N.L.: No limit

●: Standard items

TQS 20



Precision grooving and parting inserts with ground chip breaker

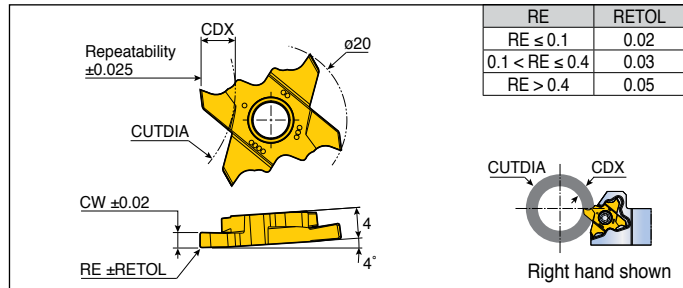

RE	RETOL
RE ≤ 0.1	0.02
0.1 < RE ≤ 0.4	0.03
RE > 0.4	0.05

Designation	Feed (mm/rev)	CW	RE	CDX	CUTDIA					Grade	
					CDX ≤ 2.2	CDX ≤ 2.7	CDX ≤ 3.5	CDX ≤ 4.0	CDX ≤ 4.5		CDX ≤ 5.0
TQS 20-0.50-0.05-R/L	0.03-0.07	0.50	0.05	2.2	N.L.	-	-	-	-	-	●
20-1.00-0.10-R/L	0.03-0.07	1.00	0.10	2.7	N.L.	N.L.	-	-	-	-	●
20-1.50-0.10-R/L	0.03-0.10	1.50	0.10	5.0	N.L.	N.L.	70	50	30	16	●
20-2.00-0.10-R/L	0.04-0.12	2.00	0.10	5.0	N.L.	N.L.	70	50	30	16	●
20-2.00-1.00-R/L*	0.05-0.13	2.00	1.00	5.0	N.L.	N.L.	70	50	30	16	●
20-2.50-0.10-R/L	0.04-0.15	2.50	0.10	5.0	N.L.	N.L.	70	50	30	16	●
20-3.00-0.10-R/L	0.04-0.16	3.00	0.10	5.0	N.L.	N.L.	70	50	30	16	●
20-3.00-1.50-R/L*	0.04-0.16	3.00	1.50	5.0	N.L.	N.L.	70	50	30	16	●

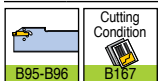

• N.L.: No limit
• *: Full radius insert

●: Standard items

TQJ 27

Precision grooving and parting inserts

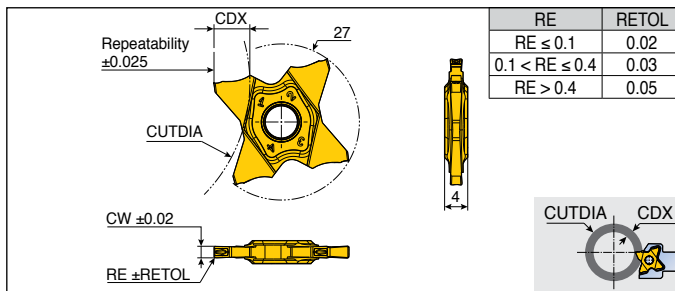

RE	RETOL
RE ≤ 0.1	0.02
0.1 < RE ≤ 0.4	0.03
RE > 0.4	0.05

Designation	Feed (mm/rev)	CW	RE	CDX	CUTDIA											Grade
					T≤3.0	T≤3.5	T≤4.0	T≤4.5	T≤5.0	T≤5.5	T≤5.7	T≤6.0	T≤6.2	T≤6.4		
TQJ 27-0.50-0.00	0.02-0.04	0.50	0.00	1.0	-	-	-	-	-	-	-	-	-	-	-	●
27-0.50-0.04	0.02-0.04	0.50	0.04	2.5	-	-	-	-	-	-	-	-	-	-	-	●
27-0.75-0.10	0.02-0.05	0.75	0.10	2.5	-	-	-	-	-	-	-	-	-	-	-	●
27-0.80-0.00	0.02-0.05	0.80	0.00	1.6	-	-	-	-	-	-	-	-	-	-	-	●
27-1.00-0.06	0.03-0.07	1.00	0.06	3.5	N.L.	600	-	-	-	-	-	-	-	-	-	●
27-1.00-0.10	0.03-0.07	1.00	0.10	3.5	N.L.	600	-	-	-	-	-	-	-	-	-	●
27-1.04-0.00	0.03-0.07	1.04	0.00	2.0	-	-	-	-	-	-	-	-	-	-	-	●
27-1.20-0.00	0.03-0.07	1.20	0.00	2.0	-	-	-	-	-	-	-	-	-	-	-	●
27-1.25-0.10	0.03-0.07	1.25	0.10	3.5	N.L.	600	-	-	-	-	-	-	-	-	-	●
27-1.25-0.20	0.03-0.07	1.25	0.20	3.5	N.L.	600	-	-	-	-	-	-	-	-	-	●
27-1.40-0.00	0.03-0.08	1.40	0.00	2.0	-	-	-	-	-	-	-	-	-	-	-	●
27-1.47-0.00	0.03-0.08	1.47	0.00	2.5	-	-	-	-	-	-	-	-	-	-	-	●
27-1.50-0.10	0.03-0.08	1.50	0.10	5.7	N.L.	600	280	180	130	50	35	-	-	-	-	●
27-1.50-0.20	0.03-0.08	1.50	0.20	5.7	N.L.	600	280	180	130	50	35	-	-	-	-	●
27-1.57-0.10	0.03-0.08	1.57	0.10	3.0	N.L.	-	-	-	-	-	-	-	-	-	-	●
27-1.57-0.15	0.03-0.08	1.57	0.15	3.0	N.L.	-	-	-	-	-	-	-	-	-	-	●
27-1.70-0.10	0.03-0.08	1.70	0.10	3.0	N.L.	-	-	-	-	-	-	-	-	-	-	●
27-1.75-0.10	0.03-0.08	1.75	0.10	3.0	N.L.	-	-	-	-	-	-	-	-	-	-	●
27-1.75-0.20	0.03-0.08	1.75	0.20	3.0	N.L.	-	-	-	-	-	-	-	-	-	-	●
27-1.78-0.18	0.04-0.10	1.78	0.18	3.0	N.L.	-	-	-	-	-	-	-	-	-	-	●
27-1.85-0.20	0.04-0.10	1.85	0.20	3.0	N.L.	-	-	-	-	-	-	-	-	-	-	●
27-1.96-0.15	0.04-0.10	1.96	0.15	3.0	N.L.	-	-	-	-	-	-	-	-	-	-	●
27-2.00-0.10	0.04-0.10	2.00	0.10	6.4	N.L.	600	280	180	130	105	85	60	50	30	-	●
27-2.00-0.20	0.04-0.10	2.00	0.20	6.4	N.L.	600	280	180	130	105	85	60	50	30	-	●
27-2.22-0.15	0.04-0.10	2.22	0.15	3.5	N.L.	600	-	-	-	-	-	-	-	-	-	●
27-2.30-0.20	0.04-0.10	2.30	0.20	3.5	N.L.	600	-	-	-	-	-	-	-	-	-	●
27-2.39-0.15	0.04-0.10	2.39	0.15	5.7	N.L.	600	280	180	130	50	35	-	-	-	-	●
27-2.47-0.20	0.04-0.10	2.47	0.20	5.7	N.L.	600	280	180	130	50	35	-	-	-	-	●
27-2.50-0.10	0.04-0.10	2.50	0.10	5.7	N.L.	600	280	180	130	50	35	-	-	-	-	●
27-2.50-0.30	0.05-0.12	2.50	0.30	5.7	N.L.	600	280	180	130	50	35	-	-	-	-	●
27-2.70-0.10	0.05-0.12	2.70	0.10	6.2	N.L.	600	280	180	135	105	95	85	78	-	-	●
27-2.87-0.20	0.05-0.12	2.87	0.20	6.2	N.L.	600	280	180	135	105	95	85	78	-	-	●

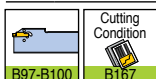

● N.L. = No limit

● Standard items

TQJ 27



Precision grooving and parting inserts

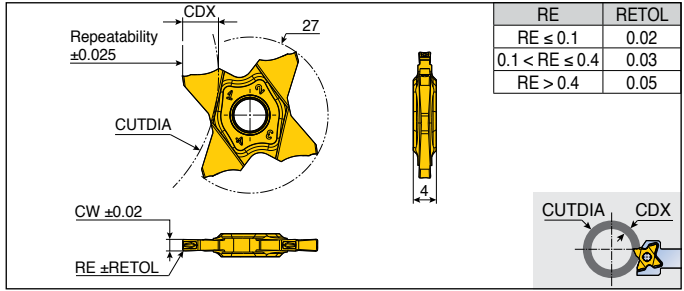

Designation	Feed (mm/rev)	CW	RE	CDX	CUTDIA										Grade
					T≤3.0	T≤3.5	T≤4.0	T≤4.5	T≤5.0	T≤5.5	T≤5.7	T≤6.0	T≤6.2	T≤6.4	
TQJ 27-3.00-0.00	0.05-0.12	3.00	0.00	6.4	N.L.	600	280	180	135	105	95	85	78	55	●
27-3.00-0.20	0.05-0.12	3.00	0.20	6.4	N.L.	600	280	180	135	105	95	85	78	55	●
27-3.00-0.30	0.05-0.12	3.00	0.30	6.4	N.L.	600	280	180	135	105	95	85	78	55	●
27-3.00-0.40	0.05-0.12	3.00	0.40	6.4	N.L.	600	280	180	135	105	95	85	78	55	●
27-3.15-0.15	0.05-0.12	3.15	0.15	6.4	N.L.	600	280	180	135	105	95	85	78	68	●
27-3.18-0.20	0.05-0.12	3.18	0.20	6.4	N.L.	600	280	180	135	105	95	85	78	68	●

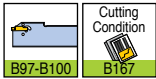

● N.L. = No limit

●: Standard items

TQJ 27



Parting inserts

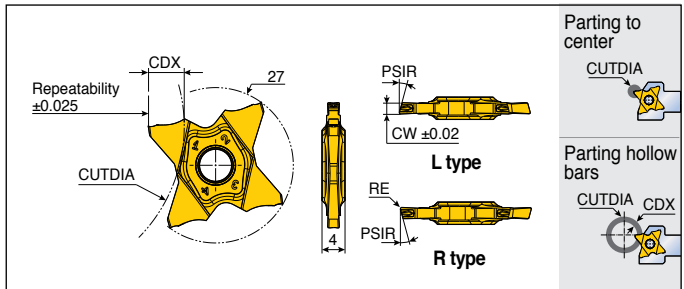

Designation	Feed (mm/rev)	CW	RE	PSIR	Parting to center		Parting hollow bars		Grade
					CUTDIA	CDX	CUTDIA	TT9080	
TQJ 27-1.00-15R/L	0.02-0.06	1.00	0.06	15°	7.0	3.5	600	●	
27-1.50-6R/L	0.02-0.06	1.50	0.06	6°	12.0	5.7	35	●	
27-1.50-15R/L	0.02-0.06	1.50	0.06	15°	12.0	5.7	35	●	
27-2.00-6R/L	0.03-0.08	2.00	0.10	6°	13.0	6.4	30	●	
27-2.00-15R/L	0.03-0.08	2.00	0.10	15°	13.0	6.4	30	●	

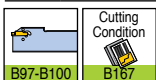

●: Standard items

TQJ 27

Full radius inserts

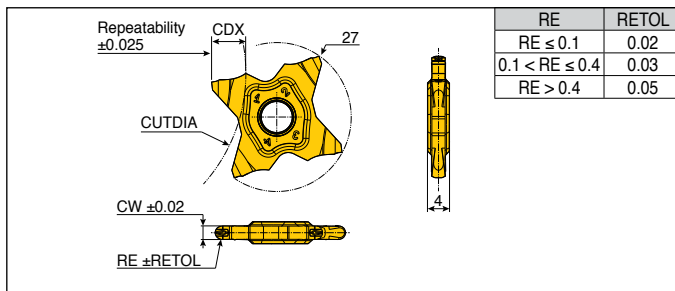

Designation	Feed (mm/rev)	CW	RE	CDX	CUTDIA										Grade	
					T≤3.0	T≤3.5	T≤4.0	T≤4.5	T≤5.0	T≤5.5	T≤5.7	T≤6.0	T≤6.2	T≤6.4		TT9080
TQJ 27-1.57-0.79	0.05-0.08	1.57	0.79	3.0	N.L.	-	-	-	-	-	-	-	-	-	-	●
27-2.00-1.00	0.05-0.11	2.00	1.00	3.5	N.L.	600	-	-	-	-	-	-	-	-	-	●
27-2.39-1.20	0.05-0.11	2.39	1.20	5.7	N.L.	600	280	180	130	50	35	-	-	-	-	●
27-3.00-1.50	0.06-0.12	3.00	1.50	6.4	N.L.	600	280	180	135	105	95	85	78	55	-	●

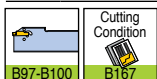

• N.L. = No limit

• Standard items

TQJ 27

DIN 471 circlip grooving and shallow grooving inserts

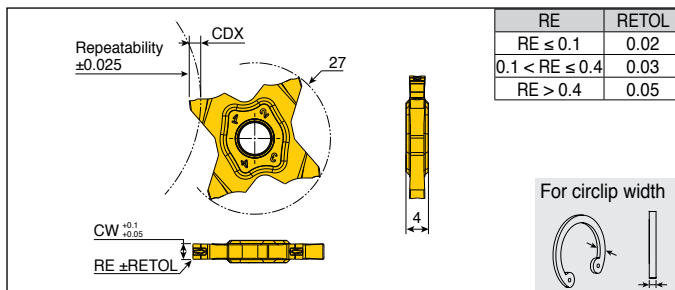

For circlip width

Designation	Feed (mm/rev)	CW	RE	CDX	For circlip width	Grade
						TT9080
TQJ 27-1.10-0.08-CG	0.03-0.07	1.10	0.08	1.50	1.10	●
27-1.30-0.08-CG	0.03-0.07	1.30	0.08	1.50	1.30	●
27-1.60-0.08-CG	0.03-0.08	1.60	0.08	2.00	1.60	●
27-1.85-0.08-CG	0.03-0.08	1.85	0.08	2.00	1.85	●
27-2.15-0.08-CG	0.04-0.10	2.15	0.08	2.50	2.15	●
27-2.65-0.15-CG	0.05-0.12	2.65	0.15	2.50	2.65	●

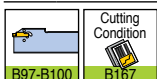

• When selecting insert, please keep in your mind insert tolerance

• Standard items

Precision grooving and parting inserts

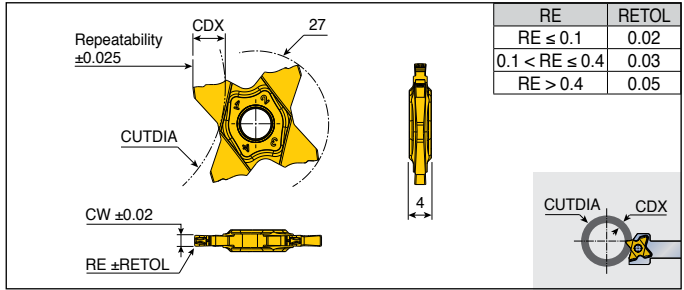

RE	RETOL
RE ≤ 0.1	0.02
0.1 < RE ≤ 0.4	0.03
RE > 0.4	0.05

Designation	Feed (mm/rev)	CW	RE	CDX	CUTDIA												Grade
					T ≤ 3.0	T ≤ 3.5	T ≤ 4.0	T ≤ 4.5	T ≤ 5.0	T ≤ 5.5	T ≤ 5.7	T ≤ 6.0	T ≤ 6.2	T ≤ 6.4	T ≤ 6.5	TT9080	
TQC 27-1.50-0.10	0.05-0.08	1.50	0.10	5.7	N.L.	600	280	180	130	50	35	-	-	-	-	●	
27-1.50-0.20	0.05-0.06	1.50	0.20	5.7	N.L.	600	280	180	130	50	35	-	-	-	-	●	
27-1.57-0.15	0.05-0.08	1.57	0.15	3.0	N.L.	-	-	-	-	-	-	-	-	-	-	●	
27-1.70-0.10	0.05-0.09	1.70	0.10	3.0	N.L.	-	-	-	-	-	-	-	-	-	-	●	
27-1.75-0.10	0.05-0.10	1.75	0.10	3.0	N.L.	-	-	-	-	-	-	-	-	-	-	●	
27-1.75-0.20	0.05-0.09	1.75	0.20	3.0	N.L.	-	-	-	-	-	-	-	-	-	-	●	
27-1.78-0.18	0.05-0.11	1.78	0.18	3.0	N.L.	-	-	-	-	-	-	-	-	-	-	●	
27-1.85-0.20	0.05-0.11	1.85	0.20	3.0	N.L.	-	-	-	-	-	-	-	-	-	-	●	
27-1.96-0.15	0.05-0.11	1.96	0.15	3.0	N.L.	-	-	-	-	-	-	-	-	-	-	●	
27-2.00-0.10	0.05-0.17	2.00	0.10	6.4	N.L.	600	280	180	130	105	85	60	50	30	-	●	
27-2.00-0.20	0.05-0.15	2.00	0.20	6.4	N.L.	600	280	180	130	105	85	60	50	30	-	●	
27-2.22-0.15	0.05-0.15	2.22	0.15	3.5	N.L.	600	-	-	-	-	-	-	-	-	-	●	
27-2.30-0.20	0.05-0.16	2.30	0.20	3.5	N.L.	600	-	-	-	-	-	-	-	-	-	●	
27-2.39-0.15	0.05-0.16	2.39	0.15	5.7	N.L.	600	280	180	130	50	35	-	-	-	-	●	
27-2.47-0.20	0.05-0.19	2.47	0.20	5.7	N.L.	600	280	180	130	50	35	-	-	-	-	●	
27-2.50-0.10	0.05-0.20	2.50	0.10	5.7	N.L.	600	280	180	130	50	35	-	-	-	-	●	
27-2.50-0.30	0.05-0.17	2.50	0.30	5.7	N.L.	600	280	180	130	50	35	-	-	-	-	●	
27-2.70-0.10	0.05-0.19	2.70	0.10	6.2	N.L.	600	280	180	135	105	95	85	78	-	-	●	
27-2.87-0.20	0.05-0.19	2.87	0.20	6.2	N.L.	600	280	180	135	105	95	85	78	-	-	●	
27-3.00-0.00	0.05-0.11	3.00	0	6.4	N.L.	600	280	180	135	105	95	85	78	55	-	●	
27-3.00-0.20	0.06-0.23	3.00	0.20	6.4	N.L.	600	280	180	135	105	95	85	78	55	-	●	
27-3.00-0.30	0.06-0.25	3.00	0.30	6.4	N.L.	600	280	180	135	105	95	85	78	55	-	●	
27-3.00-0.40	0.06-0.25	3.00	0.40	6.4	N.L.	600	280	180	135	105	95	85	78	55	-	●	
27-3.15-0.15	0.06-0.21	3.15	0.15	6.4	N.L.	600	280	180	135	105	95	85	78	68	-	●	
27-3.18-0.20	0.06-0.23	3.18	0.20	6.4	N.L.	600	280	180	135	105	95	85	78	68	-	●	
27-3.30-0.10	0.06-0.23	3.30	0.10	6.5	N.L.	600	280	180	135	105	85	65	50	40	35	●	
27-3.48-0.20	0.06-0.23	3.48	0.20	6.5	N.L.	600	280	180	135	105	85	65	50	40	35	●	
27-3.56-0.20	0.06-0.23	3.56	0.20	6.5	N.L.	600	280	180	135	105	85	65	55	40	35	●	
27-3.74-0.20	0.06-0.23	3.74	0.20	6.5	N.L.	600	280	180	135	105	85	65	55	40	35	●	
27-3.98-0.20	0.07-0.30	3.98	0.20	6.5	N.L.	600	280	180	135	105	95	85	78	40	45	●	
27-4.00-0.30	0.07-0.30	4.00	0.30	6.5	N.L.	600	280	180	135	105	95	85	78	40	45	●	
27-4.00-0.40	0.07-0.30	4.00	0.40	6.5	N.L.	600	280	180	135	105	95	85	78	40	45	●	
27-4.00-0.80	0.07-0.30	4.00	0.80	6.5	N.L.	600	280	180	135	105	95	85	78	40	45	●	
27-4.15-0.15	0.07-0.30	4.15	0.15	6.5	N.L.	600	280	180	135	105	95	85	78	40	45	●	
27-4.23-0.10	0.07-0.30	4.23	0.10	6.5	N.L.	600	280	180	135	105	95	85	78	55	65	●	

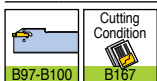

● N.L. = No limit

●: Standard items

TQC 27



Parting inserts

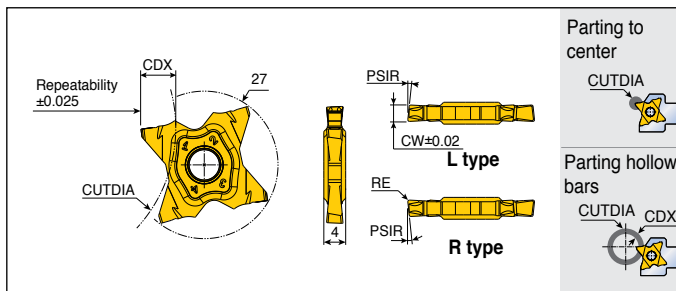

Designation	Feed (mm/rev)	CW	RE	PSIR	Parting to center			Grade
					CUTDIA	CDX	CUTDIA	
TQC 27-1.50-6R/L	0.03-0.07	1.50	0.06	6°	12.0	5.7	35	●
27-1.50-15R/L	0.03-0.07	1.50	0.06	15°	12.0	5.7	35	●
27-2.00-6R/L	0.04-0.14	2.00	0.10	6°	13.0	6.4	30	●
27-2.00-15R/L	0.04-0.14	2.00	0.10	15°	13.0	6.4	30	●

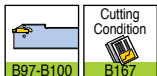

●: Standard items

TQC 27



Full radius inserts

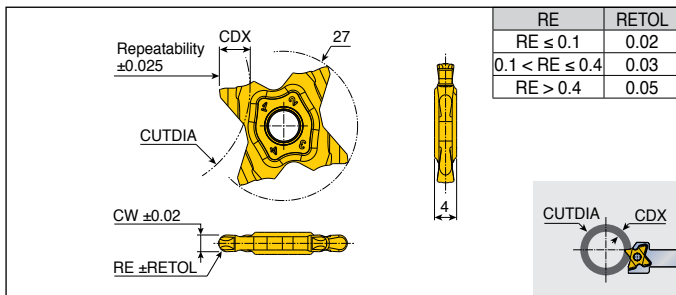

Designation	Feed (mm/rev)	CW	RE	CDX	CUTDIA										Grade		
					T≤3.0	T≤3.5	T≤4.0	T≤4.5	T≤5.0	T≤5.5	T≤5.7	T≤6.0	T≤6.2	T≤6.4			
TQC 27-1.57-0.79	0.05-0.09	1.57	0.79	3.0	N.L.	-	-	-	-	-	-	-	-	-	-	-	●
27-2.00-1.00	0.05-0.13	2.00	1.00	3.5	N.L.	600	-	-	-	-	-	-	-	-	-	-	●
27-2.39-1.20	0.06-0.17	2.39	1.20	5.7	N.L.	600	280	180	130	50	35	-	-	-	-	-	●
27-3.00-1.50	0.06-0.20	3.00	1.50	6.4	N.L.	600	280	180	135	105	95	85	78	55	-	-	●

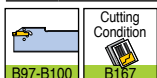

● N.L. = No limit

●: Standard items

TQS 27-MT

Partial profile 60° threading inserts

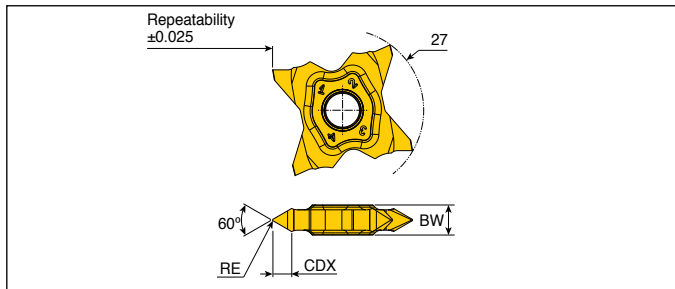

Designation	Dimension (mm)							Grade TT9080
	TPN	TPX	TPIX	TPIN	RE	BW	CDX	
TQS 27-4MT-0.05	0.45	3	48	8	0.05	4	2.8	●
27-4MT-0.14	1.11	3	23	8	0.14	4	2.7	●
27-5MT-0.15	1.25	3	20	8	0.15	5	3.1	●
27-5MT-0.20	1.63	3	16	8	0.20	5	3.1	●
27-6MT-0.25	1.94	3	13	8	0.25	6	3.6	●

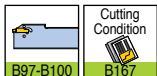

- TPN: Thread pitch minimum (mm)
- TPX: Thread pitch maximum (mm)
- TPIX: Thread per inch maximum
- TPIN: Thread per inch minimum

●: Standard items

TQS 27-WT

Partial profile 55° threading inserts

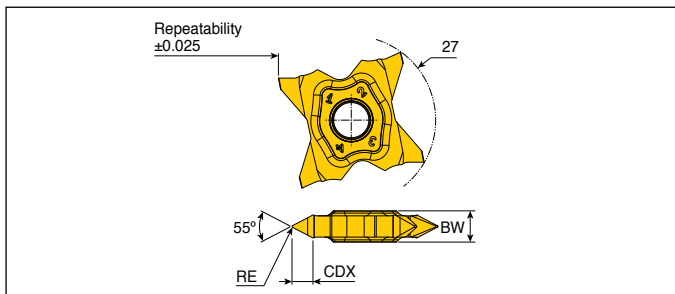

Designation	Dimension (mm)					Grade TT9080
	TPIX	TPIN	RE	BW	CDX	
TQS 27-4WT-0.05	54	10	0.05	4	2.9	●
27-5WT-0.15	19	10	0.15	5	3.3	●
27-6WT-0.25	12	9	0.25	6	3.9	●

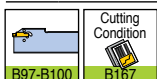

- TPIX: Thread per inch maximum
- TPIN: Thread per inch minimum

●: Standard items

TQS 27-ISO

ISO metric full profile, external threading inserts

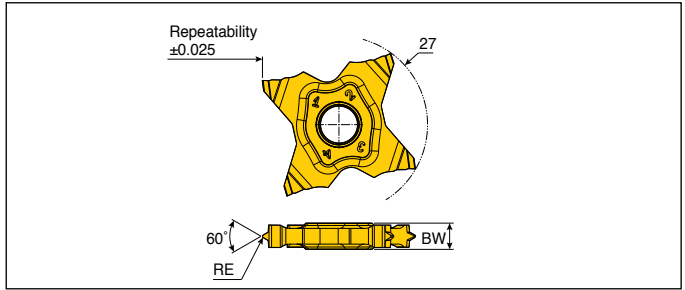

Designation	Dimension (mm)			Grade
	TP	RE	BW	TT9080
TQS 27-0.5-ISO	0.50	0.08	4	●
27-0.75-ISO	0.75	0.11	4	●
27-0.8-ISO	0.80	0.12	4	●
27-1.0-ISO	1.00	0.14	4	●
27-1.25-ISO	1.25	0.18	4	●
27-1.5-ISO	1.50	0.22	4	●
27-1.75-ISO	1.75	0.25	4	●
27-2.0-ISO	2.00	0.28	4	●

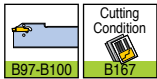

● TP: Thread pitch (mm)

●: Standard items

TQS 27-UN

American UN (UNC, UNF, UNEF) full profile, external threading inserts

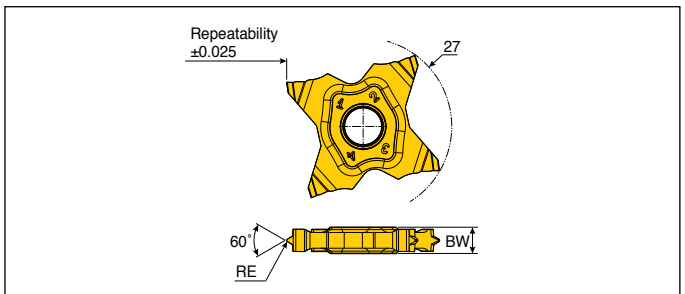

Designation	Dimension (mm)			Grade
	TPI	RE	BW	TT9080
TQS 27-24-UN	24	0.13	4	●
27-20-UN	20	0.16	4	●
27-18-UN	18	0.16	4	●
27-16-UN	16	0.21	4	●
27-14-UN	14	0.23	4	●
27-12-UN	12	0.27	4	●

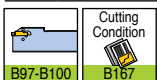

● TPI: Thread per inch

●: Standard items

TQS 27-W

Whitworth (BSW, BSF, BSP) full profile, external threading inserts

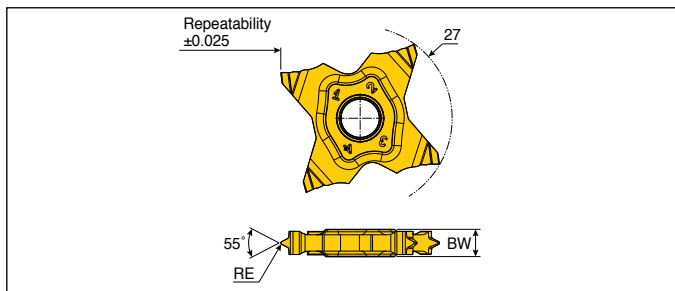

Designation	Dimension (mm)			Grade
	TPI	RE	BW	TT9080
TQS 27-28-W	28	0.09	4	●
27-19-W	19	0.15	4	●
27-18-W	18	0.16	4	●
27-16-W	16	0.19	4	●
27-14-W	14	0.21	4	●
27-12-W	12	0.25	4	●

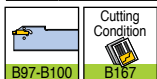

● TPI: Thread per inch

● Standard items

TQC 34

Parting inserts

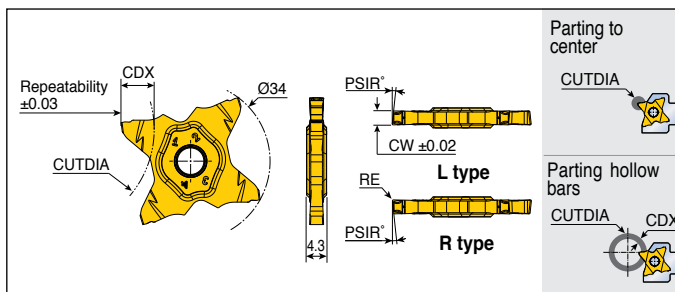

Designation	Feed (mm/rev)	CW	RE	PSIR°	Parting to center		Parting hollow bars		Grade
					CUTCIA	CDX	CUTCIA	TT9080	
TQC 34-1.50-8R/L	0.03-0.10	1.50	0.07	8	18.5	9	40	●	
34-2.00-6R/L	0.03-0.15	2.00	0.10	6	18.5	9	40	●	
34-2.00-15R/L	0.03-0.15	2.00	0.10	15	18.5	9	40	●	
34-3.00-6R/L	0.03-0.18	3.00	0.20	6	20.0	10	20	●	

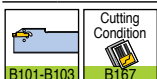

● Standard items

TDIT **3.20** - **0.00** - **0.25** - - **TT8020**

1 **2** **3** **4** **5** **6**

1 Main style of insert

T type: Chip breaker
G type: Non-chip breaker

2 Insert width

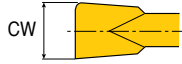

3 Corner radius

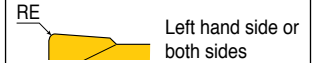

4 Corner radius

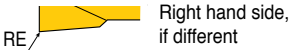

5 Additional codes

6 Grades

Parting & Grooving	Turning & Grooving
<p>TDJ / TDC</p> <p>TSJ / TSC</p>	<p>TDT TDA TDG</p> <p>TDIT TDFT</p> <p>Internal Facing</p>

Special profile inserts

Tailor-made inserts are available upon request.

Shape	Designation	Remarks
	TDT 4.00-0.50	Symmetrical type
	TDT 3.20-0.00-0.25	Non-symmetrical type
	TDT 3.30-1.65	Full-R type
	TDT 4.00-0.30-5RA	L: Chamfer on left hand side R: Chamfer on right hand side
	TDT 3.10-0.10-15LA	
	TDG 5.28-1.20-R25A	
	TDT 5.28-1.20-L25A	

Shape	Designation	Remarks
	TDG 4.40-1.82-29A	L: Chamfer on left hand side R: Chamfer on right hand side
	TDT 4.40-1.50-30A	
	TDT 5.28-2.05-45R25L	
	TDG 4.40-0.15-60A	
	TDG 5.40-0.10-30R50L	
	TDT 3.90-4.00	
	TDT 1.90-T3.5C	
	TDT 1.90-0.30-4.20T	

Shape	Designation
	TDG 1.98-T4.5C
	TDFT 3.80E-0.25
	TDIT 2.60-1.30
The others	Available upon customer's request

Heavy Industry

Tailor-made

Designation	Dimension (mm)	Remarks
XNMR 401416-HD		
XNGT 332-GV		

► Specific dimensions

External holder

Right handed shown

Internal holder

Right handed shown

Facing holder

Right handed shown

External holder

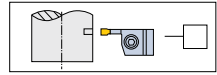

Facing holder

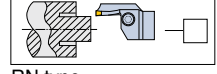
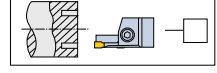

RN type

Internal holder

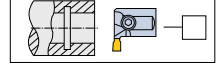

Holder handed

- Right handed
- Light handed

Insert

- Grade: _____
- Chip breaker type: _____

Quantity

- _____ pcs

Workpieces

- Part: _____
- Material: _____
- Hardness: _____

Comment

■ Customer: _____ ■ Contact: _____
 ■ Address : _____
 ■ Telephone : _____ ■ Fax : _____
 ■ E-mail : _____

Recommended Cutting Conditions

Parting

ISO	Material	Condition	Tensile strength (N/mm ²)	Hardness HB	Material No.	Cutting speed Vc(m/min)				
						TT9080	TT4430	TT7220 TT8020	K10	
P	Non-alloy steel, cast steel, free cutting steel	<0.25%C	Annealed	420	125	1	140-250	120-220	80-120	
		>=0.25%C	Annealed	650	190	2	130-220	100-190	80-110	
		<0.55%C	Quenched and tempered	850	250	3	90-200	80-170	70-90	
		>=0.55%C	Annealed	750	220	4	100-220	80-190	70-100	
			Quenched and tempered	1000	300	5	70-170	70-140	40-70	
	Low alloy steel and cast steel (Less than 5% of alloying elements)	Annealed		600	200	6	90-120	80-110	70-100	
				930	275	7	80-170	80-140	50-70	
		Quenched and tempered		1000	300	8	70-130	70-110	40-60	
				1200	350	9	50-120	50-100	30-50	
	High alloy steel, cast steel and tool steel	Annealed	680	200	10	60-140	60-120	50-80		
Quenched and tempered		1100	325	11	50-70	40-60	30-60			
M	Stainless steel and cast steel	Ferritic / martensitic	680	200	12	70-170	60-150	60-120		
		Martensitic	820	240	13	60-150	60-120	60-90		
		Austenitic	600	180	14	90-180	80-150	60-90		
K	Gray cast iron (GG)	Ferritic		160	15	150-260			60-80	
		Pearlitic		250	16	130-190			50-70	
	Cast iron nodular (GGG)	Ferritic		180	17	140-230			70-100	
		Pearlitic		260	18	110-180			70-90	
	Malleable cast iron	Ferritic		130	19	170-270			60-85	
Pearlitic			230	20	140-230			45-75		
N	Aluminum - Wrought alloy	Not cureable		60	21					
		Cured		100	22					
	Aluminum-cast, alloyed	<=12% Si	Not cureable		75	23				
			Cured		90	24				
	>12% Si	High temp.		130	25					
		Free cutting		110	26					
	Copper alloys	Brass		90	27					
		Electrolitic copper		100	28					
	Non-metallic	Duroplastics, fiber plastics			29					
		Hard rubber			30					
S	High temp. alloys	Fe based	Annealed		200	31	40-70			35-50
			Cured		280	32	30-50			25-40
		Ni or Co based	Annealed		250	33	30-40			20-30
			Cured		350	34	15-25			15-20
			Cast		320	35	15-30			15-20
	Titanium, Ti alloys		Rm 400		36	90-190			150-200	
		Alpha+beta alloys cured	Rm 1050		37	30-60			50-80	
H	Hardened steel	Hardened		55HRC	38					
		Hardened		60HRC	39					
	Chilled cast iron	Cast		400	40					
	Cast iron nodular	Hardened		55HRC	41					

• For more information of material groups, see the materials & grades "material conversion table"

■ Steel
 ■ Stainless steel
 ■ Cast iron
 ■ Nonferrous
 ■ High temp. alloys
 ■ Hardened steel

Recommended Cutting Conditions

Grooving and Turning

ISO	Material	Condition	Tensile strength (N/mm ²)	Hardness HB	Material No.	Cutting speed Vc(m/min)		
							KP300	
P	Non-alloy steel, cast steel, free cutting steel	<0.25%C	Annealed	420	125	1		
		≥0.25%C	Annealed	650	190	2		
		<0.55%C	Quenched and tempered	850	250	3		
		≥0.55%C	Annealed	750	220	4		
			Quenched and tempered	1000	300	5		
	Low alloy steel and cast steel (Less than 5% of alloying elements)		Annealed		600	200	6	
					930	275	7	
			Quenched and tempered		1000	300	8	
					1200	350	9	
	High alloy steel, cast steel and tool steel		Annealed	680	200	10		
			Quenched and tempered	1100	325	11		
M	Stainless steel and cast steel	Ferritic / martensitic	680	200	12			
		Martensitic	820	240	13			
		Austenitic	600	180	14			
K	Gray cast iron (GG)	Ferritic		160	15			
		Pearlitic		250	16			
	Cast iron nodular (GGG)	Ferritic		180	17			
		Pearlitic		260	18			
	Malleable cast iron	Ferritic		130	19			
Pearlitic			230	20				
N	Aluminum - Wrought alloy	Not cureable		60	21	150-2500		
		Cured		100	22	150-2500		
	Aluminum-cast, alloyed	≤12% Si	Not cureable		75	23	150-2500	
			Cured		90	24	150-2500	
		>12% Si	High temp.		130	25	330-800	
	Copper alloys	>1% Pb	Free cutting		110	26		
			Brass		90	27	330-800	
			Electrolitic copper		100	28	190-400	
	Non-metallic		Duroplastics, fiber plastics			29		
			Hard rubber			30		
S	High temp. alloys	Fe based	Annealed		200	31		
			Cured		280	32		
		Ni or Co based	Annealed		250	33		
			Cured		350	34		
			Cast		320	35		
	Titanium, Ti alloys			Rm 400		36		
Alpha+beta alloys cured			Rm 1050		37			
H	Hardened steel	Hardened		55HRC	38			
		Hardened		60HRC	39			
	Chilled cast iron	Cast		400	40			
	Cast iron nodular	Hardened		55HRC	41			

• For more information of material groups, see the materials & grades "material conversion table"

■ Steel
 ■ Stainless steel
 ■ Cast iron
 ■ Nonferrous
 ■ High temp. alloys
 ■ Hardened steel

Recommended Cutting Conditions

Face grooving and Internal grooving

ISO	Material	Condition	Tensile strength (N/mm ²)	Hardness HB	Material No.	Cutting speed Vc(m/min)		
						TT7505		
P	Non-alloy steel, cast steel, free cutting steel	<0.25%C	Annealed	420	125	1		
		≥0.25%C	Annealed	650	190	2		
		<0.55%C	Quenched and tempered	850	250	3		
		≥0.55%C	Annealed	750	220	4		
			Quenched and tempered	1000	300	5		
	Low alloy steel and cast steel (Less than 5% of alloying elements)		Annealed		600	200	6	
					930	275	7	
			Quenched and tempered		1000	300	8	
					1200	350	9	
	High alloy steel, cast steel and tool steel		Annealed	680	200	10		
			Quenched and tempered	1100	325	11		
M	Stainless steel and cast steel	Ferritic / martensitic	680	200	12			
		Martensitic	820	240	13			
		Austenitic	600	180	14			
K	Gray cast iron (GG)	Ferritic		160	15	90-140		
		Pearlitic		250	16	80-120		
	Cast iron nodular (GGG)	Ferritic		180	17	90-130		
		Pearlitic		260	18	80-110		
	Malleable cast iron	Ferritic		130	19	80-130		
Pearlitic			230	20	60-100			
N	Aluminum - Wrought alloy	Not cureable		60	21			
		Cured		100	22			
	Aluminum-cast, alloyed	≤12% Si	Not cureable		75	23		
			Cured		90	24		
		>12% Si	High temp.		130	25		
	Copper alloys		>1% Pb	Free cutting		110	26	
				Brass		90	27	
				Electrolitic copper		100	28	
	Non-metallic		Duroplastics, fiber plastics				29	
			Hard rubber					30
S	High temp. alloys	Fe based	Annealed		200	31		
			Cured		280	32		
		Ni or Co based	Annealed		250	33		
			Cured		350	34		
			Cast		320	35		
	Titanium, Ti alloys			Rm 400			36	
Alpha+beta alloys cured			Rm 1050				37	
H	Hardened steel	Hardened		55HRC	38	15-25		
				60HRC	39	15-25		
	Chilled cast iron	Cast		400	40	15-25		
Cast iron nodular	Hardened		55HRC	41	15-25			

• For more information of material groups, see the materials & grades "material conversion table"

■ Steel
 ■ Stainless steel
 ■ Cast iron
 ■ Nonferrous
 ■ High temp. alloys
 ■ Hardened steel

Recommended Cutting Conditions

Face grooving and Internal grooving

Cutting speed Vc(m/min)							
TT6080	TT3010	TT5100	TT9080	TT4430	TT7220 TT8020	K10	
		110-160	100-150	100-130	80-110		
		70-110	60-100	60-90	50-80		
		70-120	60-110	60-100	50-90		
		70-120	60-110	60-100	40-70		
		80-120	70-110	70-100	40-60		
		70-100	60-90	60-80	30-50		
		70-100	60-90	60-80	30-50		
		60-90	50-80	50-70	30-40		
		60-140	50-130	50-110	40-80		
		50-140	40-130	40-110	30-80		
70-120						40-60	
60-100						40-60	
70-110						40-60	
60-90						30-50	
60-110						20-40	
50-90						20-40	
						100-300	
						100-300	
						100-300	
						100-300	
						80-200	
						80-150	
						60-100	
	30-50	30-50	20-40	20-30	15-25		
	25-40	20-40	15-30	15-25	10-15		
	25-35	20-30	15-20	15-20	10-15		
	20-30	20-30	15-20	15-20	10-15		
	20-30	20-30	15-20	15-20	10-15		
	100-130	100-130	90-120	80-100	60-80		
	30-60	30-60	20-50	20-40	15-30		
15-20						15-20	
15-20						15-20	
15-25						15-25	
15-25						15-25	

Recommended Cutting Conditions

T-CLAMP ceramic insert

Material		Grooving	Turning
P	High hardened steel	Vc (m/min)	250-350
		F (mm/rev)	0.08-0.20
K	Cast iron	Vc (m/min)	600-800
		F (mm/rev)	0.1-0.24

• Above condition is adapted to TDT 4E-0.4T CE AB30

TOP-MICRO carbide bars







	Cutting speed Vc(m/min)	Feed (mm/rev)		
		Turning / Back turning	Grooving	Face grooving
P	30-150	0.01-0.08	0.01-0.05	0.01-0.04
M	30-130			
K	30-150			
N	50-200			
S	10-50			

THREAD MAKING

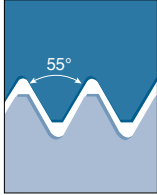
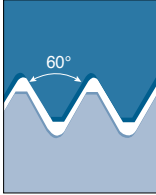
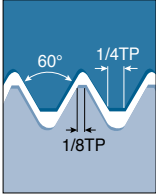
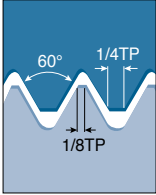

Tool Selection Guide

Threading inserts

Thread		<i>T-THREAD</i>			
		55° thread	60° thread	Metric ISO	American UN
					
Pages		C19	C20	C21 - C25	C26 - C30
Type of threading		Partial profile	Partial profile	Full profile	Full profile
Application		General use for 55° thread forms for wide range of pitches	General use for 60° thread forms for wide range of pitches	General usage for all industries	General usage for all industries
 M - type	ER	●	●	●	●
	IR	●	●	●	●
 Regular type	ER/IR	●	●	●	●
	EL/IL	●	●	●	●
 B - type	ER	●	●	●	●
	IR	●	●	●	●
 U - type	IRL	●	●	●	●
	EIRL	●	●		
	ERL			●	
 Multi-tooth type	ER			●	●
	IR			●	●

ER: External right hand

ERL: External right / left hand

EL: External left hand

IRL: Internal Right / left hand

IR: Internal right hand

EIRL: External / internal right / left hand

IL: Internal left hand

Tool Selection Guide





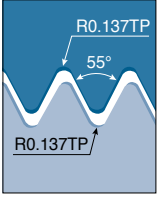
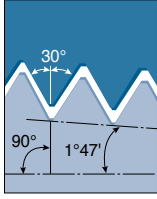
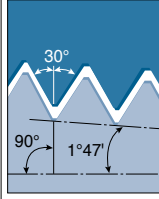
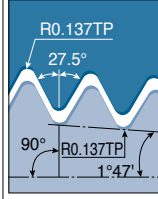
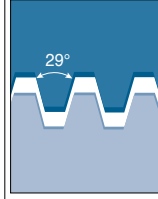
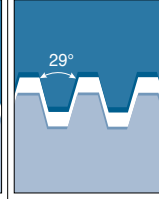

Threading inserts

T-THREAD

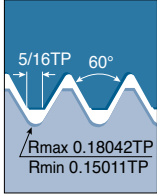
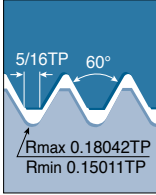
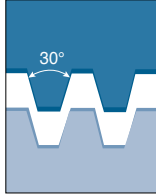
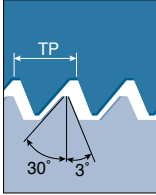
Whitworth	NPT	NPTF	BSPT	STUB ACME	ACME
					
C31 - C34	C35 - C36	C37	C38	C39	C40
Full profile	Full profile	Full profile	Full profile	Partial profile	Partial profile
General industries. Pipe fittings and couplings	Steam, gas and water pipes	Steam, gas and water pipes. Dry seal	55° form for steam, gas and water pipes	Shallow ACME profile for motion transmission	Motion transmission. Feed screws
•	•		•		
•	•		•		
•	•	•	•	•	•
•	•		•	•	•
•	•		•		
•	•		•		
					•
					•
•	•				
•	•				

Tool Selection Guide

Threading inserts

		T-THREAD			
		UNJ	MJ	Trapez DIN 103	Sagengengewinde DIN 513
Thread					
Pages		C41 - C42	C43	C44	C46
Type of threading		Full profile	Full profile	Partial profile	Full profile
Application		Aviation and aerospace industry	Aviation and aerospace industry	Motion transmission. Feed screws	For high force in one direction
 M - type	ER				
	IR				
 Regular type	ER/IR	●	●	●	●
	EL/IL	●		●	●
 B - type	ER				
	IR	●			
 U - type	ER/IR				●
	EL/IL				●
	ERL/IRL			●	
 Multi-tooth type	ER				
	IR				

ER: External right hand

ERL: External right / left hand

EL: External left hand

IRL: Internal Right / left hand

IR: Internal right hand

EIRL: External / internal right / left hand

IL: Internal left hand

Tool Selection Guide

Threading inserts

T-THREAD

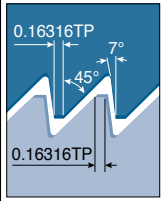
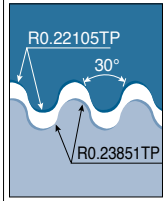
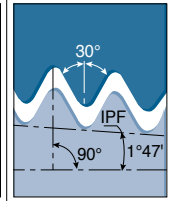
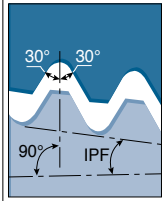
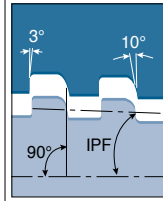
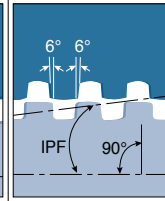
American buttress	Round DIN 405	API round	API	Buttress casing	Extreme line casing
					
C47	C48	C49	C50	C51	C51
Full profile	Full profile	Full profile	Full profile	Full profile	Full profile
For high force in one direction	Pipe coupling in fire fighting, chemical and food industries	60° thread with large radius in the oil and gas industry	60° thread form for pipe connections in the oil and gas industry	Tube and casings in the oil and gas industry	Tube and casings in the oil and gas industry
	•				
	•				
•	•	•	•	•	•
•	•	•	•		
•					

Grades

Thread making grades

Grades	ISO	Characteristics & applications
TT7010 PVD coated	P05 – P25 K05 – K25	<ul style="list-style-type: none"> • General machining of steel and cast iron
TT8010 PVD coated	P30 – P50 M30 – M50 S30 – S50	<ul style="list-style-type: none"> • Toughest grade in threading product line • For a wide range of threading on low carbon steel & low carbon alloy steel • Medium to low speed threading of stainless steel and exotic materials
TT9030 PVD coated	P20 – P40 M20 – M40 S20 – S40	<ul style="list-style-type: none"> • General machining of steel • General machining of stainless steel • General machining of heat-resistant alloy
P30 Carbide	P25 – P35	<ul style="list-style-type: none"> • General machining of steel

T-THREAD

Thread Turning





1 Clamping system

S - Screw clamping

2 Application

E - External
I - Internal

3 Hand of tool

R - Right-hand
L - Left-hand

4 Shank size

External toolholders
Shank: HxB

2020: 20x20 mm

Internal toolholders
Neck diameter

0025: Neck diameter 25 mm

5 Tool length

	mm
D	- 60
F	- 80
H	- 100
K	- 125
L	- 140
M	- 150
P	- 170
R	- 200
S	- 250
T	- 300
U	- 350
V	- 400

6 Insert size

INSL (mm)	IC
06	3.97 mm = 5/32"
08	4.76 mm = 3/16"
08U	4.76 mm = 3/16"
11	6.35 mm = 1/4"
16	9.52 mm = 3/8"
22	12.70 mm = 1/2"
22U	12.70 mm = 1/2"
27	15.88 mm = 5/8"
27U	15.88 mm = 5/8"

7 Optional specifications

U - For U-type inserts
B - Bore for coolant
C - Carbide shank
D - Drop head
G - Gang tool
AD - Short type
SP - Special



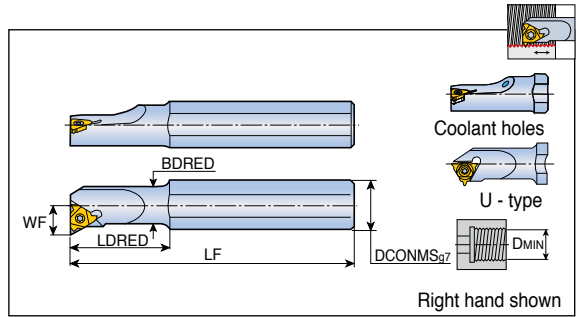

Internal threading toolholders







Designation	Dimension (mm)						Coolant hole	Insert ⁽²⁾
	DCONMS	BDRED	LF	LDRED	DMIN	WF		
SIR/L 0005 H06 ⁽¹⁾	12	5.1	100	12	6.4	4.3	X	06 IR/L...
0007 K08 ⁽¹⁾	16	6.6	125	18	9.0	5.3	X	08 IR/L...
0008 K08U ⁽¹⁾	16	7.4	125	21	9.0	6.4	X	08 UIRL...
0010 H11 ⁽¹⁾	10	10	100	-	12	7.4	X	11 IR/L...
SIR 0010 H11B ⁽¹⁾	10	10	100	-	12	7.4	●	11 IR...
SIR/L 0010 K11 ⁽¹⁾	16	10	125	25	12	6.5	X	11 IR/L...
0010 K11B ⁽¹⁾	16	10	125	25	12	7.4	●	11 IR/L...
0013 L11 ⁽¹⁾	16	13	140	32	15	8.9	X	11 IR/L...
0013 M16 ⁽¹⁾	16	13	150	32	16	10.0	X	16 IR/L...
0013 M16B ⁽¹⁾	16	13	150	32	16	10.2	●	16 IR/L...
0016 P16 ⁽¹⁾	20	16	170	40	19	11.4	X	16 IR/L...
0016 P16B ⁽¹⁾	20	16	170	40	19	11.7	●	16 IR/L...
0020-16-AD	20	20	80	-	24	13.7	X	16 IR/L...
0020 P16	20	20	170	-	24	13.4	X	16 IR/L...
0020 P16B	20	20	170	-	24	13.7	●	16 IR/L...
0025-16-AD	25	25	120	-	29	16.3	X	16 IR/L...
0025 R16	25	25	200	-	29	16.3	X	16 IR/L...
0025 R16B	25	25	200	-	29	16.2	●	16 IR/L...
0032 S16	32	32	250	-	36	19.6	X	16 IR/L...
0040 T16	40	40	300	-	44	23.8	X	16 IR/L...
0050 U16	50	50	350	-	54	28.7	X	16 IR/L...
0020 P22 ⁽¹⁾	20	20	170	-	24	15.6	X	22 IR/L...
0025 R22	25	25	200	-	29	17.2	X	22 IR/L...
0025 R22B	25	25	200	-	29	18.1	●	22 IR/L...
0032 S22	32	32	250	-	38	21.5	X	22 IR/L...
0040 T22	40	40	300	-	46	25.8	X	22 IR/L...
0050 U22	50	50	350	-	56	30.6	X	22 IR/L...
0032 S22U	32	32	250	-	38	25.5	X	22 UIRL...
0040 T22U	40	40	300	-	46	29.5	X	22 UIRL...
0032 S27	32	32	250	-	40	22.4	X	27 IR/L...
0040 T27	40	40	300	-	48	26.4	X	27 IR/L...
0050 U27	50	50	350	-	58	31.4	X	27 IR/L...
0060 V27	60	60	400	-	68	36.4	X	27 IR/L...
0032 S27U	32	32	250	-	40	24.7	X	27 UIRL...
0040 T27U	40	40	300	-	48	29.4	X	27 UIRL...
0050 U27U	50	50	350	-	58	34.3	X	27 UIRL...
0060 V27U	60	60	400	-	68	39.3	X	27 UIRL...

- ⁽¹⁾ Toolholders without anvil
- ⁽²⁾ Right hand inserts (IR) for right hand tools (SIR)
- For multi-tooth inserts use anvils AI16M, AI22M, AI27M
- All Toolholders are made with 1.5° helix angle
- Please check for spare parts C16 page





SER/L

Designation	Insert screw	Anvil screw	Anvil int./ext. right	Anvil int./ext. left	Torx wrench
					
SER 0808 H11	S11				T-8/5
SER/L 1010 H11	S11				T-8/5
SEL 1212 F16	S16	A16		AI16	T-10/5
SER 1212 F16	S16	A16	AE16		T-10/5
SEL 1616 H16	S16	A16		AI16	T-10/5
SER 1616 H16	S16	A16	AE16		T-10/5
SER 1616 K16G	S16	A16	AE16		T-10/5
SEL 2020-16-AD	S16	A16		AI16	T-10/5
SER 2020-16-AD	S16	A16	AE16		T-10/5
SEL 2020 K16	S16	A16		AI16	T-10/5
SER 2020 K16	S16	A16	AE16		T-10/5
SEL 2525 M16	S16	A16		AI16	T-10/5
SER 2525 M16	S16	A16	AE16		T-10/5
SEL 3232 P16	S16	A16		AI16	T-10/5
SER 3232 P16	S16	A16	AE16		T-10/5
SEL 2525 M22	S22	A22		AI22	T-20/5
SER 2525 M22	S22	A22	AE22		T-20/5
SEL 3232 P22	S22	A22		AI22	T-20/5
SER 3232 P22	S22	A22	AE22		T-20/5
SEL 4040 R22	S22	A22		AI22	T-20/5
SER 4040 R22	S22	A22	AE22		T-20/5
SEL 2525 M22U	S22	A22		AI22U	T-20/5
SER 2525 M22U	S22	A22	AE22U		T-20/5
SEL 3232 P22U	S22	A22		AI22U	T-20/5
SER 3232 P22U	S22	A22	AE22U		T-20/5
SEL 4040 R22U	S22	A22		AI22U	T-20/5
SEL 2525 M27	TS40	A27		AI27	TK40
SER 2525 M27	TS40	A27	AE27		TK40
SEL 3232 P27	TS40	A27		AI27	TK40
SER 3232 P27	TS40	A27	AE27		TK40
SER 4040 R27	TS40	A27	AE27		TK40
SEL 2525 M27U	TS40	A27		AI27U	TK40
SEL 3232 P27U	TS40	A27		AI27U	TK40
SER 3232 P27U	TS40	A27	AE27U		TK40
SEL 4040 R27U	TS40	A27		AI27U	TK40

SER-D

Designation	Insert screw	Anvil screw	Anvil int./ext. right	Anvil int./ext. left	Torx wrench
					
SER 2525 M16D	S16	A16	AE16	-	T-10/5
SER 2525 M22D	S22	A22	AE22	-	T-20/5

SIR/L

Designation	Insert screw	Anvil screw	Anvil int./ext. right	Anvil int./ext. left	Torx wrench
					
SIR/L 0005 H06	TS 20038I				T-6/5
SIR/L 0005 H06CB	TS 20038I				T-6/5
SIR 0005 H06-W	TS 20038I				T-6/5
SIR/L 0007 K08	TS 20054I				T-6/5
SIR/L 0007 K08CB	TS 20054I				T-6/5
SIR/L 0008 K08U	TS 20054I				T-6/5
SIR 0008 K08UCB	TS 20054I				T-6/5
SIR/L 0010 H11	S11				T-8/5
SIR 0010 H11B	S11				T-8/5
SIR/L 0010 K11	S11				T-8/5
SIR/L 0010 K11B	S11				T-8/5
SIR/L 0010 M11CB	S11				T-8/5
SIR/L 0012 P11CB	S11				T-8/5
SIR/L 0013 L11	S11				T-8/5
SIR/L 0013 M16	S16S				T-10/5
SIR/L 0013 M16B	S16S				T-10/5
SIR/L 0016 P16	S16S				T-10/5
SIR/L 0016 P16B	S16S				T-10/5
SIR 0016 R16CB	S16S				T-10/5
SIL 0020-16-AD	S16	A16	AE16		T-10/5
SIR 0020-16-AD	S16	A16		Al16	T-10/5
SIL 0020 P16	S16	A16	AE16		T-10/5
SIR 0020 P16	S16	A16		Al16	T-10/5
SIL 0020 P16B	S16	A16	AE16		T-10/5
SIR 0020 P16B	S16	A16		Al16	T-10/5
SIR 0020 S16CB	S16	A16		Al16	T-10/5
SIL 0025-16-AD	S16	A16	AE16		T-10/5
SIR 0025-16-AD	S16	A16		Al16	T-10/5
SIL 0025 R16	S16	A16	AE16		T-10/5
SIR 0025 R16	S16	A16		Al16	T-10/5
SIL 0025 R16B	S16	A16	AE16		T-10/5
SIR 0025 R16B	S16	A16		Al16	T-10/5
SIR 0025 S16CB	S16	A16		Al16	T-10/5
SIL 0032 S16	S16	A16	AE16		T-10/5
SIR 0032 S16	S16	A16		Al16	T-10/5
SIL 0040 T16	S16	A16	AE16		T-10/5
SIR 0040 T16	S16	A16		Al16	T-10/5
SIL 0050 U16	S16	A16	AE16		T-10/5
SIR 0050 U16	S16	A16		Al16	T-10/5

16 E R M 1.50 ISO 2M TT9030

1 2 3 4 5 6 7 8

1 Insert size

INSL (mm)	IC
06	3.97 mm = 5/32"
08	4.76 mm = 3/16"
11	6.35 mm = 1/4"
16	9.52 mm = 3/8"
22	12.70 mm = 1/2"
27	15.88 mm = 5/8"

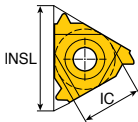

2 Application

- E** - External
- I** - Internal
- UE** - U-type, external
- UI** - U-type, Internal
- UEI** - U-type, external and internal

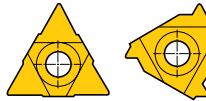

U-type Regular type

3 Hand of tool

- R** - Right-hand
- L** - Left-hand
- RL** - Right and left-hand

4 Type

- M** - With a chip breaker
- B** - Peripherally ground & chip breaker
- No indication regular type

5 Pitch

Full profile

Value by number

0.35 - 9.0 mm (Thread pitch)

72 - 2 TPI (Threads per inch)

Partial profile

Range by letter

	mm (Thread pitch)	TPI (Threads per inch)
A	0.5 - 1.5 mm	48 - 16
AG	0.5 - 3.0 mm	48 - 8
G	1.75 - 3.0 mm	14 - 8
N	3.5 - 5.0 mm	7 - 5
Q	5.5 - 6.0 mm	4.5 - 4
U	5.5 - 9.0 mm	4.5 - 2.75

6 Thread standard

- 60** - Partial profile 60°
- 55** - Partial profile 55°
- ISO** - ISO metric
- UN** - American UN
- W** - Whitworth
- BSPT** - British BSPT
- RND** - Round DIN 405
- TR** - Trapeze DIN 103
- ACME** - ACME
- STACME** - Stub ACME
- ABUT** - American buttress
- UNJ** - UNJ
- MJ** - MJ ISO 5855
- NPT** - NPT
- API RD** - API round
- BUT** - API buttress casing
- API** - API
- EL** - Extreme line casing
- SAGE** - Sagengewinde DIN 513

7 No. of teeth (Optional)

- 2M** - 2 teeth
- 3M** - 3 teeth

8 Grades

Coated
TT7010
TT8010
TT9030

Uncoated
P30

Partial Profile 55°

External & internal

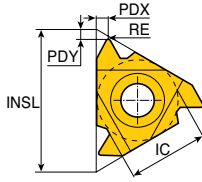



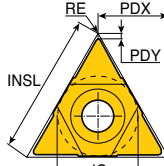

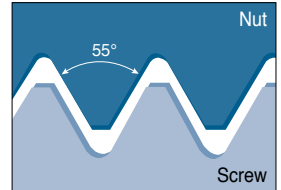

External right hand shown
(Internal left hand)



U-type



- Application: General industry

Insert	Designation	Pitch		Dimension (mm)					Coated			Uncoated	
		TP (mm)	TPI	IC	INSL	RE	PDY	PDX	TT7010	TT9030	TT8010	P30	
External  Regular  B/M 	11ER/L A 55	0.5-1.5	48-16	6.35	11	0.05	0.8	0.9	•	•			
	16ER/L A 55	0.5-1.5	48-16	9.52	16	0.05	0.8	0.9		•		•	
	16ER/L AG 55	0.5-3.0	48-8	9.52	16	0.05	1.2	1.7	•	•	•		
	16ERB AG 55	0.5-3.0	48-8	9.52	16	0.05	1.2	1.7		•			
	16ERM AG 55	0.5-3.0	48-8	9.52	16	0.07	1.2	1.7	•	•		•	
	16ER/L G 55	1.75-3.0	14-8	9.52	16	0.20	1.2	1.7	•	•			
	16ERB G 55	1.75-3.0	14-8	9.52	16	0.20	1.2	1.7		•			
	16ERM G 55	1.75-3.0	14-8	9.52	16	0.23	1.2	1.7	•	•			
	22ER/L N 55	3.5-5.0	7-5	12.70	22	0.42	1.7	2.5	•	•			
27ER Q 55	5.5-6.0	4.5-4	15.88	27	0.60	2.0	2.9		•				
Internal  Regular  B/M 	06IR/L A 55	0.5-1.25	48-20	3.97	6	0.05	0.5	0.6			•		
	08IR/L A 55	0.5-1.5	48-16	4.76	8	0.05	0.6	0.7		•	•		
	11IR/L A 55	0.5-1.5	48-16	6.35	11	0.05	0.8	0.9	•	•	•		
	16IR A 55	0.5-1.5	48-16	9.52	16	0.05	0.8	0.9		•			
	16IR/L AG 55	0.5-3.0	48-8	9.52	16	0.05	1.2	1.7	•	•			
	16IRB AG 55	0.5-3.0	48-8	9.52	16	0.05	1.2	1.7		•			
	16IRM AG 55	0.5-3.0	48-8	9.52	16	0.05	1.2	1.7	•	•			
	16IR/L G 55	1.75-3.0	14-8	9.52	16	0.20	1.2	1.7	•	•			
	16IRB G 55	1.75-3.0	14-8	9.52	16	0.20	1.2	1.7		•			
U 	16IRM G 55	1.75-3.0	14-8	9.52	16	0.20	1.2	1.7	•	•			
	22IR/L N 55	3.5-5.0	7-5	12.70	22	0.42	1.7	2.5	•	•		•	
	27IR/L Q 55	5.5-6.0	4.5-4	15.88	27	0.60	2.0	2.9		•			
	08UIRL U 55	1.75-2.0	14-11	4.76	8	0.10	0.9	4.0			•		
	22UEIRL U 55	5.5-8.0	4.5-3.25	12.70	22	0.60	0.9	11.0	•				

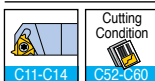

- ERB / ERM / IRB / IRM with pressed chip breaker

- Standard items

Partial Profile 60°

External & internal

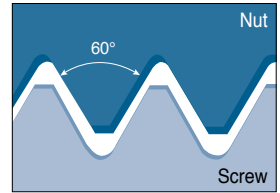
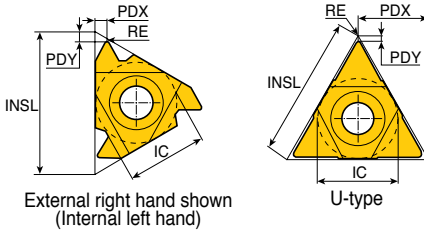

• Application: General industry

Insert	Designation	Pitch		Dimension (mm)					Coated			Uncoated
		TP (mm)	TPI	IC	INSL	RE	PDY	PDX	TT7010	TT9030	TT8010	P30
	11ER/L A 60	0.5-1.5	48-16	6.35	11	0.05	0.8	0.9		●		
	16ER/L A 60	0.5-1.5	48-16	9.52	16	0.05	0.8	0.9	●	●	●	
	16ERB A 60	0.5-1.5	48-16	9.52	16	0.05	0.8	0.9		●		
	16ERM A 60	0.5-1.5	48-16	9.52	16	0.05	0.8	0.9	●	●		●
	16ER/L AG 60	0.5-3.0	48-8	9.52	16	0.06	1.2	1.7	●	●	●	●
	16ERB AG 60	0.5-3.0	48-8	9.52	16	0.05	1.2	1.7		●		
	16ERM AG 60	0.5-3.0	48-8	9.52	16	0.06	1.2	1.7	●	●		●
	16ER/L G 60	1.75-3.0	14-8	9.52	16	0.17	1.2	1.7	●	●	●	
	16ERB G 60	1.75-3.0	14-8	9.52	16	0.17	1.2	1.7		●		
	16ERM G 60	1.75-3.0	14-8	9.52	16	0.17	1.2	1.7	●	●		●
	22ER/L N 60	3.5-5.0	7-5	12.70	22	0.32	1.7	2.5	●	●	●	
	22ERM N 60	3.5-5.0	7-5	12.70	22	0.32	1.7	2.5	●	●		●
27ER/L Q 60	5.5-6.0	4.5-4	15.88	27	0.63	2.1	3.1	●	●		●	
	06IR/L A 60	0.5-1.25	48-20	3.97	6	0.05	0.6	0.6			●	
	06IRM A 60	0.5-1.25	48-20	3.97	6	0.05	0.5	0.6			●	
	08IR/L A 60	0.5-1.5	48-16	4.76	8	0.05	0.6	0.7			●	
	08IRM A 60	0.5-1.5	48-16	4.76	8	0.05	0.6	0.7			●	
	11IR/L A 60	0.5-1.5	48-16	6.35	11	0.05	0.8	0.9	●	●		
	11IRM A 60	0.5-1.5	48-16	6.35	11	0.05	0.7	0.9	●	●		
	16IR/L A 60	0.5-1.5	48-16	9.52	16	0.05	0.8	0.9	●	●	●	●
	16IRB A 60	0.5-1.5	48-16	9.52	16	0.05	0.8	0.9		●		
	16IRM A 60	0.5-1.5	48-16	9.52	16	0.05	0.8	0.9	●	●		●
	16IR/L AG 60	0.5-3.0	48-8	9.52	16	0.05	1.2	1.7	●	●	●	●
	16IRB AG 60	0.5-3.0	48-8	9.52	16	0.05	1.2	1.7		●		
	16IRM AG 60	0.5-3.0	48-8	9.52	16	0.05	1.2	1.7	●	●		●
16IR/L G 60	1.75-3.0	14-8	9.52	16	0.12	1.2	1.7		●	●		
16IRB G 60	1.75-3.0	14-8	9.52	16	0.12	1.2	1.7		●			
16IRM G 60	1.75-3.0	14-8	9.52	16	0.10	1.2	1.7	●	●		●	
22IR/L N 60	3.5-5.0	7-5	12.70	22	0.22	1.7	2.5	●	●			
22IRM N 60	3.5-5.0	7-5	12.70	22	0.19	1.7	2.5	●	●		●	
27IR/L Q 60	5.5-6.0	4.5-4	15.88	27	0.31	2.1	3.1	●	●		●	
	08UIRL U 60	1.75-2.0	14-11	4.76	8	0.10	0.8	4.0			●	
	22UEIRL U 60	5.5-8.0	4.5-3.25	12.70	22	0.28	0.6	11.0	●	●		
	27UEIRL U 60	6.5-9.0	4-2.75	15.88	27	0.28	1.0	13.7	●			

• ERB / ERM / IRB / IRM with pressed chip breaker

●: Standard items

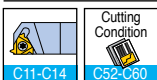

External ISO Metric

Full profile (DIN13 12-1986 class: 6G)

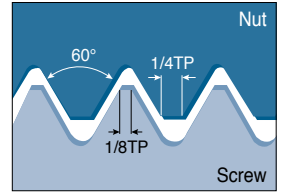
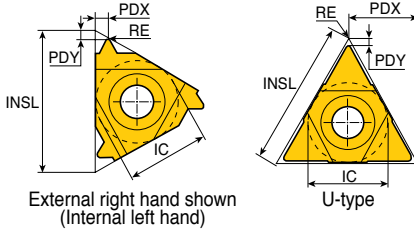

• Application: General industry

Insert	Designation	TP (mm)	Dimension (mm)					Coated			Uncoated
			IC	INSL	RE	PDY	PDX	TT7010	TT9030	TT8010	P30
External	11ER/L 0.35 ISO	0.35	6.35	11	0.04	0.8	0.4		•		
	11ER 0.40 ISO	0.40	6.35	11	0.04	0.7	0.4		•		
Regular	11ER 0.45 ISO	0.45	6.35	11	0.05	0.7	0.4			•	
	11ER/L 0.50 ISO	0.50	6.35	11	0.05	0.6	0.6	•	•		
	11ER 0.60 ISO	0.60	6.35	11	0.07	0.6	0.6		•		
	11ER 0.70 ISO	0.70	6.35	11	0.07	0.6	0.6		•		
	11ER/L 0.75 ISO	0.75	6.35	11	0.08	0.6	0.6		•		
	11ER 0.80 ISO	0.80	6.35	11	0.09	0.6	0.6		•		
	11ER/L 1.00 ISO	1.00	6.35	11	0.12	0.7	0.7		•		
	11ER 1.25 ISO	1.25	6.35	11	0.15	0.8	0.9		•		
	11ER/L 1.50 ISO	1.50	6.35	11	0.18	0.8	1.0	•	•		
	11ER 1.75 ISO	1.75	6.35	11	0.21	0.8	1.1	•			
B/M	16ER/L 0.35 ISO	0.35	9.52	16	0.04	0.8	0.4		•		
	16ER/L 0.40 ISO	0.40	9.52	16	0.04	0.7	0.4		•		
	16ER 0.45 ISO	0.45	9.52	16	0.05	0.7	0.4		•		
	16ER/L 0.50 ISO	0.50	9.52	16	0.04	0.6	0.6	•	•		
	16ERM 0.50 ISO	0.50	9.52	16	0.04	0.6	0.6		•		
	16ER 0.60 ISO	0.60	9.52	16	0.07	0.6	0.6		•		
	16ER/L 0.70 ISO	0.70	9.52	16	0.07	0.6	0.6	•	•		
	16ER/L 0.75 ISO	0.75	9.52	16	0.08	0.6	0.6	•	•		
	16ERM 0.75 ISO	0.75	9.52	16	0.08	0.6	0.6		•		
	16ER/L 0.80 ISO	0.80	9.52	16	0.09	0.6	0.6	•	•		
	16ERB 0.80 ISO	0.80	9.52	16	0.09	0.6	0.6		•		
	16ER/L 1.00 ISO	1.00	9.52	16	0.12	0.7	0.7	•	•	•	•
	16ERB 1.00 ISO	1.00	9.52	16	0.12	0.7	0.7		•		
	16ERM 1.00 ISO	1.00	9.52	16	0.11	0.7	0.7	•	•		•
	16ER/L 1.25 ISO	1.25	9.52	16	0.15	0.8	0.9	•	•		
	16ERB 1.25 ISO	1.25	9.52	16	0.15	0.8	0.9		•		
	16ERM 1.25 ISO	1.25	9.52	16	0.14	0.8	0.9	•	•		
	16ER/L 1.50 ISO	1.50	9.52	16	0.18	0.8	1.0	•	•	•	•
	16ERB 1.50 ISO	1.50	9.52	16	0.18	0.8	1.0		•		
	16ERM 1.50 ISO	1.50	9.52	16	0.19	0.8	1.0	•	•		•
	16ER/L 1.75 ISO	1.75	9.52	16	0.21	0.9	1.2	•	•	•	
	16ERB 1.75 ISO	1.75	9.52	16	0.21	0.9	1.2		•		
	16ERM 1.75 ISO	1.75	9.52	16	0.20	0.9	1.2	•	•		

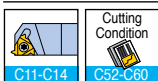

• ERB / ERM with pressed chip breaker

• Standard items

External ISO Metric

Full profile (DIN13 12-1986 class: 6G)

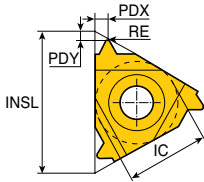

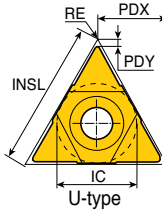

External right hand shown
(Internal left hand)

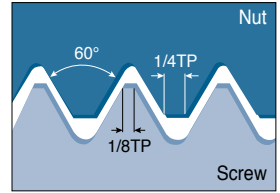

U-type



• Application: General industry

Insert	Designation	TP (mm)	Dimension (mm)					Coated			Uncoated
			IC	INSL	RE	PDY	PDX	TT7010	TT9030	TT8010	P30
 Regular  B/M	16ER/L 2.00 ISO	2.00	9.52	16	0.25	1.0	1.3	●	●	●	●
	16ERB 2.00 ISO	2.00	9.52	16	0.25	1.0	1.3		●		
	16ERM 2.00 ISO	2.00	9.52	16	0.24	1.0	1.3	●	●		
	16ER/L 2.50 ISO	2.50	9.52	16	0.31	1.1	1.5	●	●		●
	16ERB 2.50 ISO	2.50	9.52	16	0.31	1.1	1.5		●		
	16ERM 2.50 ISO	2.50	9.52	16	0.30	1.1	1.5	●	●		
	16ER/L 3.00 ISO	3.00	9.52	16	0.38	1.2	1.6	●	●	●	
	16ERB 3.00 ISO	3.00	9.52	16	0.38	1.2	1.6		●		
	16ERM 3.00 ISO	3.00	9.52	16	0.38	1.2	1.6	●	●		●
	22ER/L 3.50 ISO	3.50	12.70	22	0.44	1.6	2.3	●	●		
	22ERM 3.50 ISO	3.50	12.70	22	0.44	1.6	2.3		●		
	22ER/L 4.00 ISO	4.00	12.70	22	0.52	1.6	2.3	●	●		●
	22ERM 4.00 ISO	4.00	12.70	22	0.52	1.6	2.3		●		
	22ER/L 4.50 ISO	4.50	12.70	22	0.58	1.7	2.4	●	●		
22ER/L 5.00 ISO	5.00	12.70	22	0.64	1.7	2.5	●	●			
22ER/L 6.00 ISO	6.00	12.70	22	0.78	2.0	2.7	●				
27ER 5.50 ISO	5.50	15.88	27	0.70	1.9	2.7		●			
27ER/L 6.00 ISO	6.00	15.88	27	0.78	2.0	2.9	●	●	●		
 U	22UERL 5.50 ISO	5.50	12.70	22	0.70	2.3	11.0	●			
	22UERL 6.00 ISO	6.00	12.70	22	0.78	2.6	11.0	●		●	
	27UERL 8.00 ISO	8.00	15.88	27	1.08	2.4	13.7		●		

• ERB / ERM with pressed chip breaker

●: Standard items

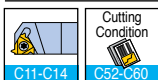

Internal ISO Metric

Full profile (DIN13 12-1986 class: 6H)

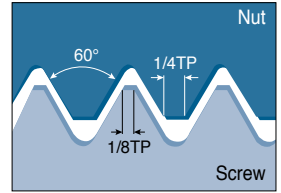
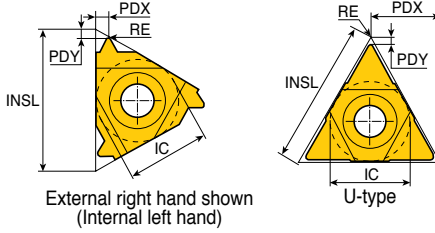

• Application: General industry

Insert	Designation	TP (mm)	Dimension (mm)					Coated			Uncoated
			IC	INSL	RE	PDY	PDX	TT7010	TT9030	TT8010	P30
Internal	06IR/L 0.50 ISO	0.50	3.97	6	0.04	0.6	0.4			•	
	06IR/L 0.75 ISO	0.75	3.97	6	0.06	0.6	0.5			•	
	06IR/L 1.00 ISO	1.00	3.97	6	0.05	0.6	0.6			•	
Regular	06IR/L 1.25 ISO	1.25	3.97	6	0.07	0.6	0.6			•	
	08IR/L 0.50 ISO	0.50	4.76	8	0.04	0.6	0.4			•	
	08IR 0.75 ISO	0.75	4.76	8	0.05	0.6	0.5			•	
B/M	08IR/L 1.00 ISO	1.00	4.76	8	0.07	0.6	0.6		•	•	
	08IR/L 1.25 ISO	1.25	4.76	8	0.09	0.7	0.7		•	•	
	08IR/L 1.50 ISO	1.50	4.76	8	0.10	0.6	0.7		•	•	
	08IR/L 1.75 ISO	1.75	4.76	8	0.15	0.6	0.9			•	
	11IR/L 0.35 ISO	0.35	6.35	11	0.04	0.8	0.3		•		
	11IR 0.40 ISO	0.40	6.35	11	0.03	0.8	0.4		•		
	11IR/L 0.50 ISO	0.50	6.35	11	0.04	0.8	0.6	•	•		
	11IRB 0.50 ISO	0.50	6.35	11	0.04	0.8	0.6		•		
	11IRM 0.50 ISO	0.50	6.35	11	0.04	0.3	0.4		•		
	11IR 0.70 ISO	0.70	6.35	11	0.05	0.6	0.6		•		
	11IR/L 0.75 ISO	0.75	6.35	11	0.05	0.6	0.6		•		
	11IRB 0.75 ISO	0.75	6.35	11	0.05	0.6	0.6		•		
	11IRM 0.75 ISO	0.75	6.35	11	0.06	0.3	0.5		•		
	11IR 0.80 ISO	0.80	6.35	11	0.04	0.6	0.6		•		
	11IR/L 1.00 ISO	1.00	6.35	11	0.07	0.6	0.7	•	•	•	•
11IRB 1.00 ISO	1.00	6.35	11	0.07	0.6	0.6		•			
11IRM 1.00 ISO	1.00	6.35	11	0.05	0.6	0.7		•			
11IR/L 1.25 ISO	1.25	6.35	11	0.09	0.8	0.8		•			
11IR/L 1.50 ISO	1.50	6.35	11	0.12	0.8	1.0	•	•	•	•	
11IRM 1.50 ISO	1.50	6.35	11	0.08	0.8	1.0	•	•			
11IR/L 1.75 ISO	1.75	6.35	11	0.12	0.8	1.0		•			
11IRB 1.75 ISO	1.75	6.35	11	0.12	0.8	1.0		•			
11IRM 1.75 ISO	1.75	6.35	11	0.15	0.6	0.9		•			
11IR/L 2.00 ISO	2.00	6.35	11	0.14	0.8	0.9	•	•	•		
11IRM 2.00 ISO	2.00	6.35	11	0.16	0.6	1.0		•			
16IR 0.35 ISO	0.35	9.52	16	0.02	0.6	0.3		•			
16IR/L 0.40 ISO	0.40	9.52	16	0.03	0.6	0.4		•			
16IR/L 0.50 ISO	0.50	9.52	16	0.04	0.6	0.6	•	•			
16IR 0.60 ISO	0.60	9.52	16	0.04	0.6	0.6		•			

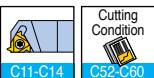

• IRB / IRM with pressed chip breaker

• Standard items

Internal ISO Metric

Full profile (DIN13 12-1986 class: 6H)

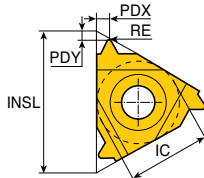



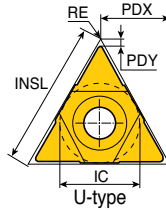

External right hand shown
(Internal left hand)

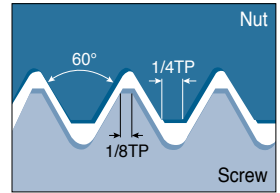

U-type



• Application: General industry

Insert	Designation	TP (mm)	Dimension (mm)					Coated			Uncoated
			IC	INSL	RE	PDY	PDX	TT7010	TT9030	TT8010	P30
 Internal  Regular  B/M	16IR/L 0.70 ISO	0.70	9.52	16	0.05	0.6	0.6	●	●		
	16IR/L 0.75 ISO	0.75	9.52	16	0.05	0.6	0.6	●	●		
	16IR/L 0.80 ISO	0.80	9.52	16	0.05	0.6	0.6	●			
	16IR/L 1.00 ISO	1.00	9.52	16	0.07	0.7	0.8	●	●		●
	16IRB 1.00 ISO	1.00	9.52	16	0.07	0.7	0.8		●		
	16IRM 1.00 ISO	1.00	9.52	16	0.05	0.6	0.7	●	●		●
	16IR/L 1.25 ISO	1.25	9.52	16	0.09	0.8	0.9	●	●		
	16IRB 1.25 ISO	1.25	9.52	16	0.09	0.7	0.8		●		
	16IRM 1.25 ISO	1.25	9.52	16	0.06	0.8	0.9	●	●		
	16IR/L 1.50 ISO	1.50	9.52	16	0.12	0.9	1.0	●	●	●	●
	16IRB 1.50 ISO	1.50	9.52	16	0.12	0.1	1.2		●		
	16IRM 1.50 ISO	1.50	9.52	16	0.08	0.8	1.0	●	●		●
	16IR/L 1.75 ISO	1.75	9.52	16	0.12	0.9	1.2	●	●		
	16IRB 1.75 ISO	1.75	9.52	16	0.12	0.9	1.2		●		
	16IRM 1.75 ISO	1.75	9.52	16	0.10	0.9	1.2	●	●		
	16IR/L 2.00 ISO	2.00	9.52	16	0.16	0.9	1.2	●	●	●	
	16IRB 2.00 ISO	2.00	9.52	16	0.14	1.0	1.2		●		
	16IRM 2.00 ISO	2.00	9.52	16	0.11	1.0	1.3	●	●		
	16IR/L 2.50 ISO	2.50	9.52	16	0.18	1.1	1.5	●	●	●	
	16IRB 2.50 ISO	2.50	9.52	16	0.18	1.2	1.5		●		
16IRM 2.50 ISO	2.50	9.52	16	0.14	1.1	1.5	●	●			
16IR/L 3.00 ISO	3.00	9.52	16	0.21	1.1	1.5	●	●	●		
16IRB 3.00 ISO	3.00	9.52	16	0.21	1.1	1.5		●			
16IRM 3.00 ISO	3.00	9.52	16	0.22	1.1	1.5	●	●			
22IL 3.00 ISO	3.00	12.70	22	0.17	1.1	1.5			●		
22IR/L 3.50 ISO	3.50	12.70	22	0.23	1.6	2.3	●	●			
22IR/L 4.00 ISO	4.00	12.70	22	0.27	1.6	2.3	●	●		●	
22IR/L 4.50 ISO	4.50	12.70	22	0.31	1.6	2.3	●	●			
22IR/L 5.00 ISO	5.00	12.70	22	0.32	1.7	2.5	●	●			
27IR/L 5.50 ISO	5.50	15.88	27	0.36	1.8	2.5	●	●			
27IR/L 6.00 ISO	6.00	15.88	27	0.40	1.8	2.5	●	●			
 U	08UIRL 2.00 ISO	2.00	4.76	8	0.14	0.8	4.3				
	22UIRL 5.50 ISO	5.50	12.70	22	0.36	2.3	11.0	●			
	27UIRL 6.00 ISO	6.00	12.70	22	0.40	2.1	11.0	●			
	27UIRL 8.00 ISO	8.00	15.88	27	0.50	2.5	13.8		●		

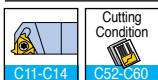

• IRB / IRM with pressed chip breaker



●: Standard items

Internal American UN

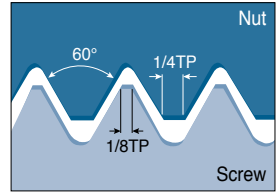
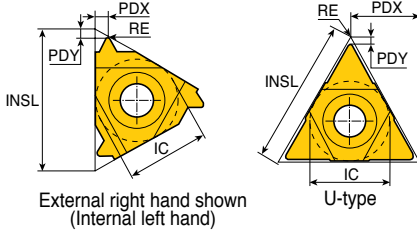
Full profile, UN, UNC, UNF, UNEF



• Application: General industry

Insert	Designation	TPI	Dimension (mm)						Coated			Uncoated
			IC	INSL	RE	PDY	PDX	TT7010	TT9030	TT8010	P30	
Internal  Regular  B/M	16IR/L 16 UN	16	9.52	16	0.09	0.9	1.1		•			
	16IRB 16 UN	16	9.52	16	0.09	0.9	1.1		•			
	16IRM 16 UN	16	9.52	16	0.09	0.9	1.1	•	•			
	16IR/L 14 UN	14	9.52	16	0.10	0.9	1.2		•			
	16IRB 14 UN	14	9.52	16	0.10	0.9	1.2		•			
	16IRM 14 UN	14	9.52	16	0.11	0.9	1.2	•	•			
	16IR/L 12 UN	12	9.52	16	0.12	1.1	1.4	•	•	•		
	16IRB 12 UN	12	9.52	16	0.12	1.1	1.4		•			
	16IRM 12 UN	12	9.52	16	0.12	1.1	1.4		•			
	16IR 11.5 UN	11.5	9.52	16	0.13	1.1	1.5		•			
	16IR 11 UN	11	9.52	16	0.14	1.1	1.5		•			
	16IR 10 UN	10	9.52	16	0.15	1.1	1.5	•	•			
	16IRB 10 UN	10	9.52	16	0.15	1.1	1.5		•			
	16IR 9 UN	9	9.52	16	0.17	1.2	1.7		•			
	16IR 8 UN	8	9.52	16	0.19	1.1	1.5		•			
	16IRB 8 UN	8	9.52	16	0.19	1.1	1.5		•			
	16IRM 8 UN	8	9.52	16	0.20	1.1	1.5	•	•			
	22IR 7 UN	7	12.70	22	0.22	1.6	2.3		•			
	22IR 6 UN	6	12.70	22	0.26	1.6	2.3		•			
	22IR 5 UN	5	12.70	22	0.32	1.6	2.3		•			
27IR 4 UN	4	15.88	27	0.41	1.8	2.7		•				
Internal  U	08UIRL 13 UN	13	4.76	8	0.10	1.0	4.0		•			

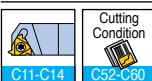

- IRB / IRM with pressed chip breaker
- Tolerance: Class 2B, ANSI B1, 3M-1986

• Standard items

External & Internal NPT



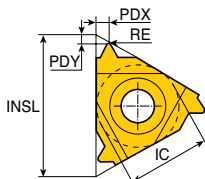

Full profile, national pipe threads (ANSI/ASME B1.20.1-1983)

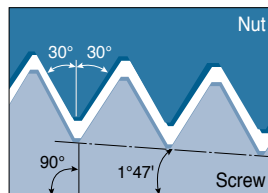

External right hand shown
(Internal left hand)



- Application: Steam, gas and water pipes

Insert	Designation	TPI	Dimension (mm)						Coated			Uncoated
			IC	INSL	RE	PDY	PDX	TT7010	TT9030	TT8010	P30	
External  Regular  B/M	16ER 27 NPT	27	9.52	16	0.04	0.7	0.8		•			
	16ER/L 18 NPT	18	9.52	16	0.06	0.8	1.0	•	•			
	16ERB 18 NPT	18	9.52	16	0.06	0.8	1.0		•			
	16ERM 18 NPT	18	9.52	16	0.05	0.8	1.0		•			
	16ER/L 14 NPT	14	9.52	16	0.07	0.9	1.2		•	•		
	16ERB 14 NPT	14	9.52	16	0.07	0.9	1.2		•			
	16ERM 14 NPT	14	9.52	16	0.05	0.9	1.2	•	•		•	
	16ER/L 11.5 NPT	11.5	9.52	16	0.09	1.1	1.5	•	•		•	
	16ERB 11.5 NPT	11.5	9.52	16	0.09	1.1	1.5		•			
	16ERM 11.5 NPT	11.5	9.52	16	0.09	1.1	1.5		•			
	16ER 8 NPT	8	9.52	16	0.12	1.3	1.8	•	•			
	16ERB 8 NPT	8	9.52	16	0.12	1.3	1.8		•			
16ERM 8 NPT	8	9.52	16	0.15	1.3	1.8	•	•				
Internal  Regular  B/M	06IR 27 NPT	27	3.97	6	0.04	0.6	0.6			•		
	08IR 27 NPT	27	4.76	8	0.04	0.6	0.6			•		
	08IR/L 18 NPT	18	4.76	8	0.06	0.6	0.6		•	•		
	11IR/L 18 NPT	18	6.35	11	0.06	0.8	1.0	•	•			
	11IR/L 14 NPT	14	6.35	11	0.07	0.8	1.0		•			
	16IR 18 NPT	18	9.52	16	0.06	0.8	1.0		•			
	16IR/L 14 NPT	14	9.52	16	0.07	0.9	1.2	•	•	•		
	16IRB 14 NPT	14	9.52	16	0.07	0.9	1.2		•			
	16IRM 14 NPT	14	9.52	16	0.05	0.9	1.2		•			
	16IR 11.5 NPT	11.5	9.52	16	0.09	1.1	1.5		•			
	16IRB 11.5 NPT	11.5	9.52	16	0.09	1.1	1.5		•			
	16IRM 11.5 NPT	11.5	9.52	16	0.09	1.1	1.5	•	•		•	
16IR/L 8 NPT	8	9.52	16	0.12	1.3	1.8		•				
16IRB 8 NPT	8	9.52	16	0.12	1.3	1.8		•				
16IRM 8 NPT	8	9.52	16	0.12	1.3	1.8		•				

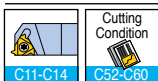

- ERB / ERM / IRB / IRM with pressed chip breaker



- Standard items

External & Internal ACME

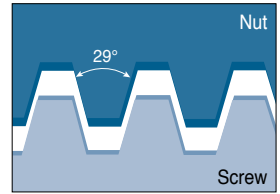
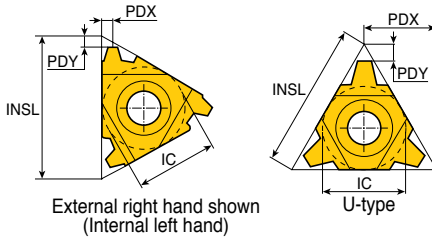
ASME / ANSI B.1.8-1988 class: 3G



• Application: Feed screws

Insert	Designation	TPI	Dimension (mm)				Coated			Uncoated	
			IC	INSL	PDY	PDX	TT7010	TT9030	TT8010	P30	
 External Regular	16ER 16 ACME	16	9.52	16	0.9	1.0		•			
	16ER 12 ACME	12	9.52	16	1.1	1.2		•			
	16ER 10 ACME	10	9.52	16	1.3	1.3		•			
	16ER/L 8 ACME	8	9.52	16	1.5	1.5		•			
	22ER/L 6 ACME	6	12.70	22	1.8	2.1		•		•	
	22ER/L 5 ACME	5	12.70	22	2.0	2.3		•			
	22ER/L 4 ACME	4	12.70	22	2.1	2.2		•			
 Internal Regular	16IR 16 ACME	16	9.52	16	0.9	1.0	•				
	16IR 12 ACME	12	9.52	16	1.1	1.2		•			
	16IR/L 10 ACME	10	9.52	16	1.3	1.3	•				
	16IR 8 ACME	8	9.52	16	1.5	1.5	•	•			
	22IR/L 6 ACME	6	12.70	22	1.8	2.1		•			
	22IR/L 5 ACME	5	12.70	22	2.0	2.3		•			
	22IR 4 ACME	4	12.70	22	2.1	2.2		•			
 Internal / External U	27UERL 4 ACME	4	12.70	22	2.3	11		•		•	
	27UERL 3 ACME	3	15.88	27	2.8	13.7		•			
	27UIRL 3 ACME	3	15.88	27	2.8	13.7		•			

•: Standard items

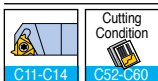

External & Internal Trapez

DIN 103

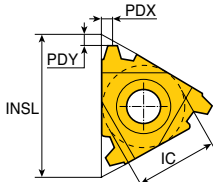

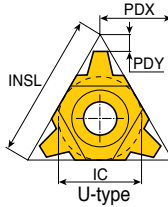

External right hand shown
(Internal left hand)

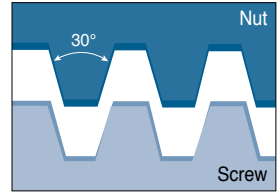

U-type



• Application: Feed screws

Insert	Designation	TP (mm)	Dimension (mm)				Coated			Uncoated	
			IC	INSL	PDY	PDX	TT7010	TT9030	TT8010	P30	
 External Regular	16ER 1.5 TR	1.5	9.52	16	1.0	1.1	●	●			
	16ER/L 2 TR	2.0	9.52	16	1.0	1.3	●	●			
	16ER/L 3 TR	3.0	9.52	16	1.3	1.5	●	●			
	22ER/L 4 TR	4.0	12.70	22	1.8	1.9	●	●			
	22ER/L 5 TR	5.0	12.70	22	2.0	2.4	●	●			
	22ER/L 6 TR	6.0	12.70	22	2.0	2.4		●			
	27ER/L 6 TR	6.0	15.88	27	2.3	2.7	●	●			
	27ER/L 7 TR	7.0	15.88	27	2.2	2.6	●	●			
 Internal Regular	08IR 1.5 TR	1.5	4.76	8	0.6	0.6			●		
	16IR 1.5 TR	1.5	9.52	16	1.0	1.1	●				
	16IR/L 2 TR	2.0	9.52	16	1.0	1.3	●	●			
	16IR/L 3 TR	3.0	9.52	16	1.3	1.5		●	●		
	22IR/L 4 TR	4.0	12.70	22	1.8	1.9	●	●			
	22IR/L 5 TR	5.0	12.70	22	2.0	2.4	●	●			
	22IR/L 6 TR	6.0	12.70	22	2.0	2.4	●	●	●	●	
	27IR/L 6 TR	6.0	15.88	27	2.3	2.7	●	●			
	27IR 7 TR	7.0	15.88	27	2.2	2.6	●				
 Internal / External U	22UERL 6 TR	6.0	12.70	22	2.0	11.0		●			
	22UERL 7 TR	7.0	12.70	22	2.3	11.0	●	●			
	22UERL 8 TR	8.0	12.70	22	2.5	11.0	●				
	27UERL 8 TR	8.0	15.88	27	2.5	13.7	●	●			
	27UERL 9 TR	9.0	15.88	27	3.0	13.7	●	●			
	27UERL 10 TR⁽¹⁾	10.0	15.88	27	3.2	13.7		●			
	08UIRL 2 TR	2.0	4.76	8	0.9	4.0			●		
	22UIRL 6 TR	6.0	12.70	22	2.0	11.0	●	●			
	22UIRL 7 TR	7.0	12.70	22	2.3	11.0	●				
	27UIRL 8 TR	8.0	15.88	27	2.5	13.7	●				
	27UIRL 9 TR	9.0	15.88	27	3.0	13.7	●	●			
	27UIRL 10 TR⁽¹⁾	10.0	15.88	27	3.2	13.7		●			

• ⁽¹⁾ One cutting edge only
 • DIN 103 04 / 1977, 150 2901 / 1977 Class 7H (7E)

●: Standard items

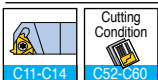



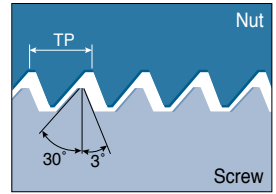
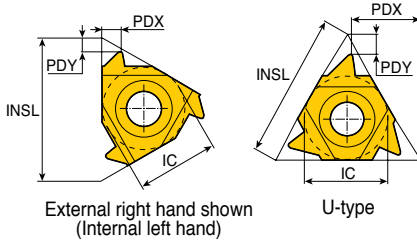

External & Internal Sagengewinde

DIN 513



• Application: For high forces in one direction

Insert	Designation	TP (mm)	Dimension (mm)				Coated			Uncoated	
			IC	INSL	PDY	PDX	TT7010	TT9030	TT8010	P30	
 External Regular	16ER/L 2 SAGE	2.0	9.52	16	1.1	1.6		●			
	22ER 3 SAGE	3.0	12.70	22	1.5	2.4		●			
	22ER 4 SAGE	4.0	12.70	22	1.9	3.1	●	●			
 External U	22UER 5 SAGE	5.0 ⁽¹⁾	12.70	22	1.2	11.6		●			
	22UER/L 6 SAGE	6.0 ⁽¹⁾	12.70	22	1.2	11.7		●			
 Internal Regular	16IR 2 SAGE	2.0	9.52	16	1.2	1.7		●			
	22IR 3 SAGE	3.0	12.70	22	1.9	2.9		●			
	22IR 4 SAGE	4.0	12.70	22	2.3	3.5		●			
 Internal U	22UIR 5 SAGE	5.0 ⁽¹⁾	12.70	22	1.9	11.7		●			
	22UIR 6 SAGE	6.0 ⁽¹⁾	12.70	22	2.1	11.9		●			

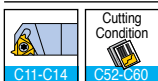

• ⁽¹⁾ Requires special anvil

●: Standard items

External & Internal American Buttress

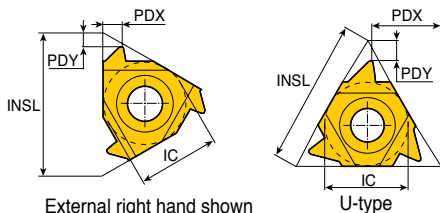



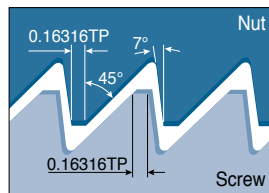

External right hand shown
(Internal left hand)

U-type



• Application: For high forces in one direction

Insert	Designation	TPI	Dimension (mm)				Coated			Uncoated
			IC	INSL	PDY	PDX	TT7010	TT9030	TT8010	P30
 External Regular	16ER 20 ABUT	20	9.52	16	1.0	1.3		•		
	16ER 16 ABUT	16	9.52	16	1.1	1.5		•		
	16ER 12 ABUT	12	9.52	16	1.4	2.0		•		
	16ER/L 10 ABUT	10	9.52	16	1.5	2.3		•		
	22ER 8 ABUT	8	12.70	22	2.1	3.3		•		
	22ER 6 ABUT	6	12.70	22	2.1	3.4		•		
 External U	22UER 4 ABUT	4	12.70	22	2.3	9.5		•		
	27UER 3 ABUT	3	15.88	27	3.1	11.7		•		
 Internal Regular	11IR 20 ABUT	20	6.35	11	1.0	1.3		•		
	11IR 16 ABUT	16	6.35	11	1.0	1.5		•		
	16IR 20 ABUT	20	9.52	16	1.0	1.3		•		
	16IR/L 16 ABUT	16	9.52	16	1.0	1.5		•		
	16IR/L 12 ABUT	12	9.52	16	1.4	2.0	•	•		
	16IR 10 ABUT	10	9.52	16	1.5	2.3		•		
	22IR 8 ABUT	8	12.70	22	2.1	3.3		•		
	22IR/L 6 ABUT	6	12.70	22	2.1	3.4		•		
 Internal U	22UIR 4 ABUT	4	12.70	22	2.3	9.5	•			

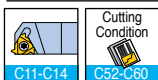

• ANSI B1.9-1973 class 2

• Standard items

API - Oil Threads



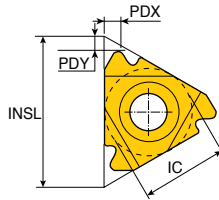

Round profile

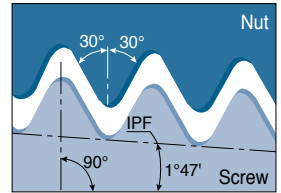

External right hand shown
(Internal left hand)



- Application: Oil & gas industry

Insert	Designation	TPI	Dimension (mm)					Coated			Uncoated
			IC	INSL	IPF	PDY	PDX	TT7010	TT9030	TT8010	P30
 External Regular	16ER 10 API RD	10	9.52	16	0.75	1.5	1.4	●	●		
	16ER/L 8 API RD	8	9.52	16	0.75	1.3	1.6	●	●		
 Internal Regular	16IR 10 API RD	10	9.52	16	0.75	1.5	1.4	●	●		
	16IR/L 8 API RD	8	9.52	16	0.75	1.3	1.6	●	●		

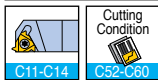

- Standard items

API - Oil Threads



Round profile, multi-tooth

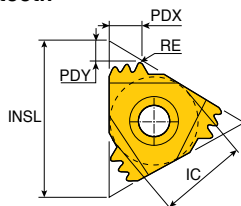

External right hand shown
(Internal left hand)

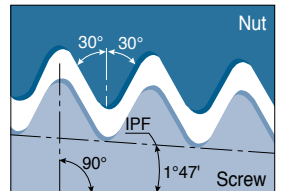

- Application: Oil & gas industry

Insert	Designation	TPI	Dimension (mm)							CICT ⁽¹⁾	Coated			Uncoated
			IC	INSL	RE	IPF	PDY	PDX	TT7010		TT9030	TT8010	P30	
 Internal / External	22ER/IR 10 API RD 2M	10	12.70	22	0.36	0.75	2.4	3.7	2		●			
	27ER/IR 8 API RD 2M	8	15.88	27	0.43	0.75	3.0	4.5	2		●			

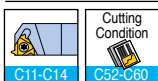

- API Spec 5B8-1996
- ⁽¹⁾ Number of teeth per corner

- Standard items

Buttress Casing / Extreme Line Casing

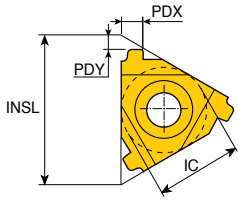

External right hand shown
(Internal left hand)

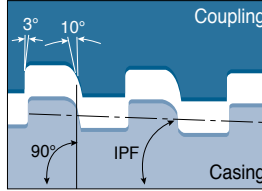

Buttress casing

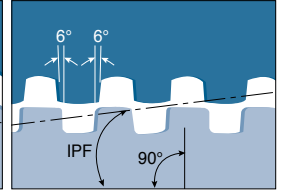

Extreme line casing



- Application: Oil & gas industry

Insert	Designation	TPI	Dimension (mm)					Connection No. or size	Coated			Uncoated
			IC	INSL	IPF	PDY	PDX		TT7010	TT9030	TT8010	
	22ER/IR 5 BUT 0.75	5	12.70	22	0.75	2.2	2.4	4-1/2" - 13-3/8"	•	•		
	22ER/IR 5 BUT 1.0	5	12.70	22	1.0	2.3	2.4	16" - 20"	•			
Buttress												
	22ER 6 EL 1.5	6	12.70	22	1.5	1.9	1.9	5" - 7-5/8"		•		
	22IR 6 EL 1.5	6	12.70	22	1.5	1.9	1.9	5" - 7-5/8"		•		
Extreme line casing												

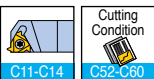

• ANSI B1.9-1973 class 2

• Standard items

Recommended Cutting Conditions

Machining data for thread turning insert

ISO	Material	Condition	Tensile strength (N/mm ²)	Hardness HB	Material No.	
P	Non-alloy steel, cast steel, free cutting steel	<0.25%C	Annealed	420	125	1
		>=0.25%C	Annealed	650	190	2
		<0.55%C	Quenched and tempered	850	250	3
		>=0.55%C	Annealed	750	220	4
			Quenched and tempered	1000	300	5
	Low alloy steel and cast steel (Less than 5% of alloying elements)	Quenched and tempered	Annealed	600	200	6
				930	275	7
				1000	300	8
				1200	350	9
	High alloy steel, cast steel and tool steel	Annealed	680	200	10	
Quenched and tempered		1100	325	11		
M	Stainless steel and cast steel	Ferritic / martensitic	680	200	12	
		Martensitic	820	240	13	
		Austenitic	600	180	14	
K	Gray cast iron (GG)	Ferritic		160	15	
		Pearlitic		250	16	
	Cast iron nodular (GGG)	Ferritic		180	17	
		Pearlitic		260	18	
	Malleable cast iron	Ferritic		130	19	
	Pearlitic		230	20		
N	Aluminum - Wrought alloy	Not cureable		60	21	
		Cured		100	22	
	Aluminum-cast, alloyed	<=12% Si	Not cureable		75	23
			Cured		90	24
		>12% Si	High temp.		130	25
	Copper alloys	>1% Pb	Free cutting		110	26
			Brass		90	27
			Electrolitic copper		100	28
Non-metallic		Duroplastics, fiber plastics			29	
		Hard rubber			30	
S	High temp. alloys	Fe based	Annealed		200	31
			Cured		280	32
		Ni or Co based	Annealed		250	33
			Cured		350	34
			Cast		320	35
	Titanium, Ti alloys		Rm 400		36	
	Alpha+beta alloys cured	Rm 1050		37		
H	Hardened steel	Hardened		55HRC	38	
		Hardened		60HRC	39	
	Chilled cast iron	Cast		400	40	
	Cast iron nodular	Hardened		55HRC	41	

• For more information of material groups, see the materials & grades "material conversion table"

■ Steel
 ■ Stainless steel
 ■ Cast iron
 ■ Nonferrous
 ■ High temp. alloys
 ■ Hardened steel

Recommended Cutting Conditions

Machining data for thread turning insert

Cutting speed (m/min)					
Coated			Uncoated		
TT7010	TT9030	TT8010	P30		
120-200	140-220	85-125	80-120		
120-200	140-220	85-125	80-120		
110-190	130-210	80-120	70-110		
110-190	130-210	80-120	70-110		
90-170	110-190	70-100	65-95		
70-120	70-120	50-70	70-110		
90-170	110-190	70-100	65-95		
80-120	100-140	60-100	70-110		
70-120	90-140	40-80	40-80		
70-100	70-100	40-70	40-70		
40-80	40-80	40-70	40-70		
85-125	90-130	40-70	40-70		
120-180	130-190	80-120	80-120		
50-100	60-110	40-60	40-60		
	100-140	80-120			
	110-150	80-120			
	110-150	80-120			
	80-120	80-120			
	110-150	60-100			
	80-120	55-95			
	1300-1500	700-900			
	400-600	330-430			
	500-800	350-450			
	370-470	300-360			
	200-280	150-210			
	260-340	160-240			
	350-450	250-310			
	100-140	80-120			
	250-350	160-200			
	250-350	150-210			
	50-70	20-50			
	30-50	20-50			
	30-50	20-40			
	20-40	15-30			
	20-40	15-30			
	120-140	90-110			
	40-60	20-50			
	30-60	20-35			
	20-40	20-30			
	20-40	20-30			
	20-30	15-25			

▶ Thread helix angle and anvil selection

■ Helix angle λ evaluation

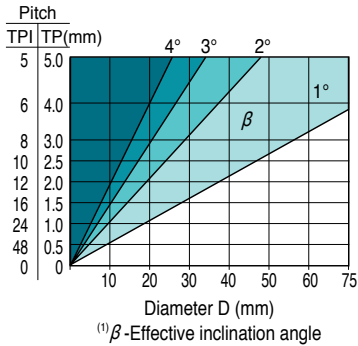

$$\operatorname{tg} \lambda = \frac{1 \times TP}{3.14 \cdot D}$$

$$\lambda^\circ = \frac{20 \times TP}{D}$$

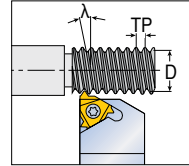

TP - Thread pitch (mm)
 D - Effective diameter of thread (mm)
 λ - Angle of inclination

▶ Anvil selection according to thread helix angle λ

		Standard								
Thread helix angle λ		$>4^\circ$	$3^\circ - 4^\circ$	$2^\circ - 3^\circ$	$1^\circ - 2^\circ$	$0^\circ - 1^\circ$	Negative anvils			
Inclination angle β		4.5°	3.5°	2.5°	1.5°	0.5°	-0.5°	-1.5°		
INSL(IC)	Toolholder	Anvil designation								
16	EX RH OR IN LH	AE 16 +4.5	AE 16 +3.5	AE 16 +2.5	AE 16	AE 16 +0.5	AE 16 -0.5	AE 16 -1.5		
(3/8)	EX LH OR IN RH	AI 16 +4.5	AI 16 +3.5	AI 16 +2.5	AI 16	AI 16 +0.5	AI 16 -0.5	AI 16 -1.5		
22	EX RH OR IN LH	AE 22 +4.5	AE 22 +3.5	AE 22 +2.5	AE 22	AE 22 +0.5	AE 22 -0.5	AE 22 -1.5		
(1/2)	EX LH OR IN RH	AI 22 +4.5	AI 22 +3.5	AI 22 +2.5	AI 22	AI 22 +0.5	AI 22 -0.5	AI 22 -1.5		
27	EX RH OR IN LH	AE 27 +4.5	AE 27 +3.5	AE 27 +2.5	AE 27	AE 27 +0.5	AE 27 -0.5	AE 27 -1.5		
(5/8)	EX LH OR IN RH	AI 27 +4.5	AI 27 +3.5	AI 27 +2.5	AI 27	AI 27 +0.5	AI 27 -0.5	AI 27 -1.5		
22U	EX RH OR IN LH	AE 22U +4.5	AE 22U +3.5	AE 22U +2.5	AE 22U	AE 22U +0.5	AE 22U -0.5	AE 22U -1.5		
(1/2U)	EX LH OR IN RH	AI 22U +4.5	AI 22U +3.5	AI 22U +2.5	AI 22U	AI 22U +0.5	AI 22U -0.5	AI 22U -1.5		
27U	EX RH OR IN LH	AE 27U +4.5	AE 27U +3.5	AE 27U +2.5	AE 27U	AE 27U +0.5	AE 27U -0.5	AE 27U -1.5		
(5/8U)	EX LH OR IN RH	AI 27U +4.5	AI 27U +3.5	AI 27U +2.5	AI 27U	AI 27U +0.5	AI 27U -0.5	AI 27U -1.5		

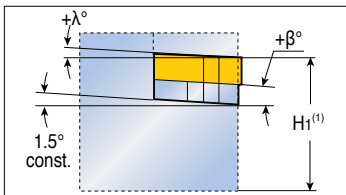

- Anvils for positive inclination angle β applicable when turning
- RH thread with RH holder or LH thread with LH holder

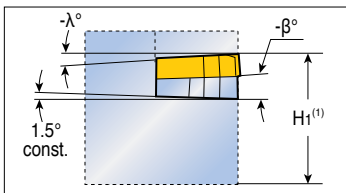

- Anvils for negative inclination β used when turning
- RH thread with LH holder or LH thread with RH holder

• ⁽¹⁾ H_1 remains constant for every anvil combination.

▶ Anvil selection according to thread helix angle λ

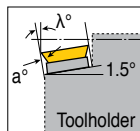
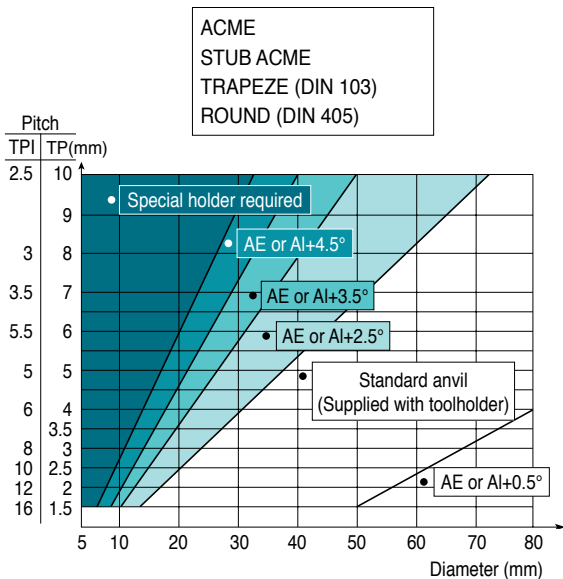

AE anvils : EX-RH and IN-LH toolholders
 AI anvils : IN-RH and EX-LH toolholders

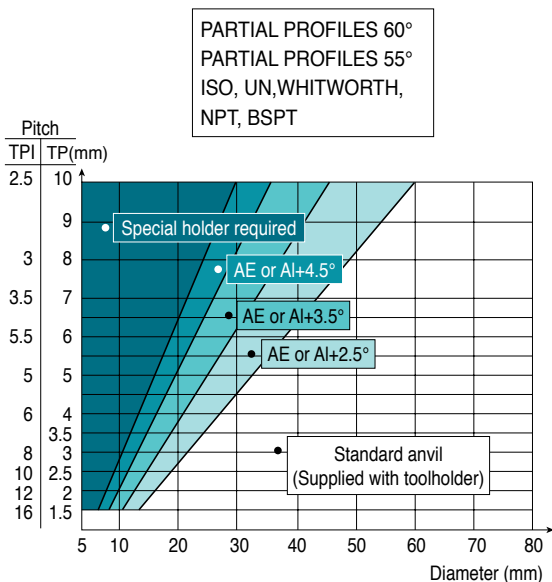

AE anvils : EX-RH and IN-LH toolholders
 AI anvils : IN-RH and EX-LH toolholders

► **Maximum depth of first cut for CNC control / external threading
- M-type inserts**

Full profile	Pitch		Insert designation	No. of passes		Max. depth for first pass (D1) mm	
	TP (mm)	TPI		Min.	Max.	Low carbon steel	
						Eq. ⁽²⁾	Dim. ⁽³⁾
ISO metric	1.00		16 ERM 1.00 ISO	5	9	0.34	0.51
	1.25		16 ERM 1.25 ISO	6	11	0.42	0.63
	1.50		16 ERM 1.50 ISO	6	12	0.46	0.69
	1.75		16 ERM 1.75 ISO	8	13	0.48	0.72
	2.00		16 ERM 2.00 ISO	8	14	0.50	0.75
	2.50		16 ERM 2.50 ISO	10	15	0.53	0.80
	3.00		16 ERM 3.00 ISO	12	17	0.56	0.84
American UN		24	16 ERM 24 UN	5	9	0.34	0.51
		20	16 ERM 20 UN	6	10	0.42	0.63
		18	16 ERM 18 UN	6	11	0.46	0.69
		16	16 ERM 16 UN	7	12	0.47	0.71
		14	16 ERM 14 UN	6	13	0.46	0.69
		12	16 ERM 12 UN	8	14	0.50	0.75
		8	16 ERM 8 UN	12	17	0.56	0.84
British BSW		19	16 ERM 19 W	6	11	0.35	0.52
		16	16 ERM 16 W	7	12	0.47	0.71
		14	16 ERM 14 W	8	13	0.50	0.75
		11	16 ERM 11 W	9	14	0.44	0.66
NPT		18	16 ERM 18 NPT	10	20	0.24	0.36
		14	16 ERM 14 NPT	13	26	0.24	0.36
		11.5	16 ERM 11.5 NPT	15	24	0.27	0.40
		8	16 ERM 8 NPT	17	30	0.31	0.46
Round		6	16 ERM 6 RND	9	20	0.42	0.63
Partial profile 60°	48-16		16 ERM A 60	(1)		0.22	0.33
	14-8		16 ERM G 60		0.50	0.75	
	48-8		16 ERM AG 60		0.24	0.36	
	7-5		16 ERM N 60		0.41	0.62	
Partial profile 55°	14-8		16 ERM G 55		0.50	0.75	
	48-8		16 ERM AG 55		0.22	0.33	

• ⁽¹⁾ As per the number of passes for the relevant pitch

⁽²⁾ Equal depth of cut method

⁽³⁾ Diminished depth of cut for each pass method

Max. depth for first pass (D1) mm							
High carbon steel		Alloy steel		Stainless steel		Nonferrous aluminum	
Eq. ⁽²⁾	Dim. ⁽³⁾	Eq. ⁽²⁾	Dim. ⁽³⁾	Eq. ⁽²⁾	Dim. ⁽³⁾	Eq. ⁽²⁾	Dim. ⁽³⁾
0.31	0.46	0.27	0.41	0.22	0.33	0.48	0.71
0.38	0.57	0.34	0.50	0.27	0.41	0.59	0.88
0.41	0.62	0.37	0.55	0.30	0.45	0.64	0.97
0.43	0.65	0.38	0.58	0.31	0.47	0.67	1.01
0.45	0.68	0.40	0.60	0.33	0.49	0.70	1.05
0.48	0.72	0.42	0.64	0.34	0.52	0.74	1.12
0.50	0.76	0.45	0.67	0.36	0.55	0.78	1.18
0.31	0.46	0.27	0.41	0.22	0.33	0.48	0.71
0.38	0.57	0.34	0.50	0.27	0.41	0.59	0.88
0.41	0.62	0.37	0.55	0.30	0.45	0.64	0.97
0.42	0.64	0.38	0.57	0.31	0.46	0.66	0.99
0.41	0.62	0.37	0.55	0.28	0.41	0.64	0.97
0.45	0.68	0.40	0.60	0.33	0.49	0.70	1.05
0.50	0.76	0.45	0.67	0.36	0.55	0.78	1.18
0.32	0.47	0.28	0.42	0.21	0.31	0.49	0.73
0.42	0.64	0.38	0.57	0.31	0.46	0.66	0.99
0.45	0.68	0.40	0.60	0.33	0.49	0.70	1.05
0.40	0.59	0.35	0.53	0.29	0.43	0.62	0.92
0.22	0.32	0.19	0.29	0.16	0.23	0.34	0.50
0.22	0.32	0.19	0.29	0.14	0.22	0.34	0.50
0.24	0.36	0.22	0.32	0.18	0.26	0.38	0.56
0.28	0.41	0.25	0.37	0.20	0.30	0.43	0.64
0.38	0.57	0.34	0.50	0.27	0.41	0.59	0.88
0.20	0.30	0.18	0.26	0.14	0.21	0.31	0.46
0.45	0.68	0.40	0.60	0.33	0.49	0.70	1.05
0.22	0.32	0.19	0.29	0.16	0.23	0.34	0.50
0.37	0.56	0.33	0.50	0.27	0.40	0.57	0.87
0.45	0.68	0.40	0.60	0.33	0.49	0.70	1.05
0.20	0.30	0.18	0.26	0.14	0.21	0.31	0.46

▶ Maximum depth of first cut for CNC control / internal threading - M-type inserts

Full profile	Pitch		Insert designation	No. of passes		Max. depth for first pass (D1) mm	
	TP (mm)	TPI		Min.	Max.	Low carbon steel	
						Eq. ⁽²⁾	Dim. ⁽³⁾
ISO metric	1.50		11 IRM 1.50 ISO	10	20	0.20	0.30
	1.00		16 IRM 1.00 ISO	9	16	0.14	0.20
	1.25		16 IRM 1.25 ISO	9	16	0.19	0.28
	1.50		16 IRM 1.50 ISO	10	20	0.20	0.30
	1.75		16 IRM 1.75 ISO	11	18	0.21	0.32
	2.00		16 IRM 2.00 ISO	12	21	0.22	0.33
	2.50		16 IRM 2.50 ISO	14	21	0.23	0.34
	3.00		16 IRM 3.00 ISO	16	22	0.24	0.35
American UN		20	16 IRM 20 UN	7	13	0.20	0.30
		18	16 IRM 18 UN	8	15	0.20	0.30
		16	16 IRM 16 UN	11	19	0.20	0.30
		14	16 IRM 14 UN	11	20	0.21	0.31
		12	16 IRM 12 UN	12	21	0.23	0.34
		8	16 IRM 8 UN	14	20	0.24	0.36
British BSW		19	16 IRM 19 W	7	12	0.28	0.42
		16	16 IRM 16 W	9	14	0.26	0.39
		14	16 IRM 14 W	10	16	0.27	0.41
		11	16 IRM 11 W	12	19	0.31	0.46
NPT		14	16 IRM 14 NPT	21	35	0.13	0.20
		11.5	16 IRM 11.5 NPT	21	33	0.17	0.25
		8	16 IRM 8 NPT	20	34	0.23	0.34
Round		6	16 IRM 6 RND	12	24	0.30	0.46
Partial profile 60°		48-16	06 IRM A 60	(1)		0.22	0.33
		48-16	08 IRM A 60			0.13	0.20
		48-16	11 IRM A 60			0.13	0.20
		48-16	16 IRM A 60			0.13	0.20
		14-8	16 IRM G 60			0.22	0.33
		48-8	16 IRM AG 60			0.14	0.21
		7-5	22 IRM N 60			0.23	0.34
Partial profile 55°		14-8	16 IRM G 55			0.34	0.50
		48-8	16 IRM AG 55			0.14	0.20

• ⁽¹⁾ As per the number of passes for the relevant pitch

⁽²⁾ Equal depth of cut method

⁽³⁾ Diminished depth of cut for each pass method

▶ Number of cutting passes for regular type inserts

Pitch	TP (mm)	0.5	1.0	1.5	2.0	2.5	3.0	4.0	6.0
	TPI	48	24	16	12	10	8	6	4
Number of passes		4-6	5-9	5-12	6-14	7-15	8-17	10-20	11-22

• For mini-tools (06IR or 08IR) add 1-3 passes. Increase for hard materials

Max. depth for first pass (D ₁) mm							
High carbon steel		Alloy steel		Stainless steel		Nonferrous aluminum	
Eq. ⁽²⁾	Dim. ⁽³⁾	Eq. ⁽²⁾	Dim. ⁽³⁾	Eq. ⁽²⁾	Dim. ⁽³⁾	Eq. ⁽²⁾	Dim. ⁽³⁾
0.18	0.27	0.16	0.24	0.12	0.18	0.28	0.42
0.13	0.18	0.11	0.16	0.09	0.13	0.20	0.28
0.17	0.25	0.15	0.22	0.12	0.18	0.27	0.39
0.18	0.27	0.16	0.24	0.12	0.18	0.28	0.42
0.19	0.29	0.17	0.26	0.14	0.21	0.29	0.45
0.20	0.30	0.18	0.26	0.14	0.21	0.31	0.46
0.21	0.31	0.18	0.27	0.15	0.22	0.32	0.48
0.22	0.32	0.19	0.29	0.16	0.23	0.34	0.50
0.18	0.27	0.16	0.24	0.12	0.18	0.28	0.42
0.18	0.27	0.16	0.24	0.12	0.18	0.28	0.42
0.18	0.27	0.16	0.24	0.13	0.20	0.28	0.42
0.19	0.28	0.17	0.25	0.13	0.19	0.29	0.43
0.21	0.31	0.18	0.27	0.15	0.22	0.32	0.48
0.22	0.32	0.19	0.29	0.16	0.23	0.34	0.50
0.25	0.38	0.22	0.34	0.17	0.25	0.39	0.59
0.23	0.35	0.21	0.31	0.17	0.25	0.36	0.55
0.24	0.37	0.22	0.33	0.18	0.27	0.38	0.57
0.28	0.41	0.25	0.37	0.20	0.30	0.43	0.64
0.12	0.18	0.10	0.16	0.08	0.12	0.18	0.28
0.15	0.23	0.14	0.20	0.11	0.16	0.24	0.35
0.21	0.31	0.18	0.27	0.14	0.20	0.32	0.48
0.27	0.41	0.24	0.37	0.20	0.30	0.42	0.64
0.20	0.30	0.18	0.26	0.14	0.21	0.31	0.46
0.12	0.18	0.10	0.16	0.08	0.13	0.18	0.28
0.12	0.18	0.10	0.16	0.08	0.13	0.18	0.28
0.12	0.18	0.10	0.16	0.08	0.13	0.18	0.28
0.20	0.30	0.18	0.26	0.14	0.21	0.31	0.46
0.13	0.19	0.11	0.17	0.09	0.14	0.20	0.29
0.21	0.31	0.18	0.27	0.15	0.22	0.32	0.48
0.31	0.45	0.27	0.40	0.22	0.33	0.48	0.70
0.13	0.18	0.11	0.16	0.09	0.13	0.20	0.28

► Recommended number of passes for multi-tooth insert

Full profile	Insert description	No. of passes	1 st pass	2 nd pass	3 rd pass	4 th pass	External / internal
ISO metric	16 ER 1.0 ISO 3M	2	0.39	0.24	-	-	External
	16 ER 1.5 ISO 2M	3	0.40	0.31	0.21	-	External
	22 ER 1.5 ISO 3M	2	0.54	0.38	-	-	External
	22 ER 2.0 ISO 2M	3	0.56	0.42	0.27	-	External
	22 ER 2.0 ISO 3M	2	0.75	0.50	-	-	External
	27 ER 3.0 ISO 2M	4	0.60	0.52	0.44	0.30	External
	16 IR 1.0 ISO 3M	2	0.32	0.26	-	-	Internal
	16 IR 1.5 ISO 2M	3	0.36	0.29	0.22	-	Internal
	22 IR 1.5 ISO 3M	2	0.49	0.38	-	-	Internal
	22 IR 2.0 ISO 2M	3	0.50	0.40	0.25	-	Internal
	22 IR 2.0 ISO 3M	2	0.72	0.43	-	-	Internal
	27 IR 3.0 ISO 2M	4	0.57	0.45	0.38	0.33	Internal
UN	16 ER 16 UN 2M	3	0.45	0.32	0.20	-	External
	22 ER 16 UN 3M	2	0.60	0.37	-	-	External
	22 ER 12 UN 2M	3	0.60	0.39	0.31	-	External
	22 ER 12 UN 3M	2	0.80	0.50	-	-	External
	27 ER 8 UN 2M	4	0.63	0.55	0.42	0.36	External
	16 IR 16 UN 2M	3	0.40	0.29	0.23	-	Internal
	22 IR 16 UN 3M	2	0.57	0.35	-	-	Internal
	22 IR 12 UN 2M	3	0.55	0.39	0.28	-	Internal
	22 IR 12 UN 3M	2	0.75	0.47	-	-	Internal
	27 IR 8 UN 2M	4	0.65	0.49	0.42	0.27	Internal
NPT	22 ER 11.5 NPT 2M	4	0.55	0.46	0.35	0.32	External
	27 ER 11.5 NPT 3M	3	0.75	0.57	0.36	-	External
	27 ER 8 NPT 2M	4	0.80	0.62	0.54	0.45	External
	22 IR 11.5 NPT 2M	4	0.55	0.46	0.35	0.32	Internal
	27 IR 11.5 NPT 3M	3	0.75	0.57	0.36	-	Internal
	27 IR 8 NPT 2M	4	0.80	0.62	0.54	0.45	Internal
Whitworth	16 ER 14 W 2M	3	0.51	0.39	0.26	-	External
	22 ER 14 W 3M	2	0.72	0.44	-	-	External
	22 ER 11 W 2M	3	0.65	0.46	0.37	-	External
	16 IR 14 W 2M	3	0.51	0.39	0.26	-	Internal
	22 IR 14 W 3M	2	0.72	0.44	-	-	Internal
	22 IR 11 W 2M	3	0.65	0.46	0.37	-	Internal
API round	22 ER 10 API RD 2M	3	0.58	0.53	0.30	-	External
	27 ER 10 API RD 3M	2	0.98	0.43	-	-	External
	27 ER 8 API RD 2M	3	0.82	0.59	0.40	-	External
	22 IR 10 API RD 2M	3	0.58	0.53	0.30	-	Internal
	27 IR 10 API RD 3M	2	0.98	0.43	-	-	Internal
	27 IR 8 API RD 2M	3	0.82	0.59	0.40	-	Internal

HOLEMAKING



HOLEMAKING



contents

Tool Selection Guide	D4
Grades	D14
Drilling Tools	
TOP-DRILL	D16
T-DRILL	D32
DRILL-SFEED	D49
DRILL-RUSH	D51
Chamfering Tool	D61
MODU-R-DRILL	D62
SPADE-RUSH	D66
SOLID-3-DRILL	D69
H-DRILL	D71
T-CHAMFER	D89
TOP-CAP	D91
T-DEEP	D98
Drilling Heads & Inserts	D151
Recommended Cutting Conditions (Drilling)	D192

Guide to Icons



➤ External Coolant



➤ Internal Coolant



➤ Through Hole



➤ Blind Hole



➤ Tube Page

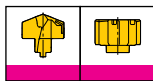

➤ Head Page



➤ Pad Page



➤ Cartridge Page

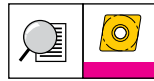

➤ Insert Page

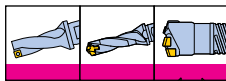

➤ Drill Body & Deep Drill Head Page



➤ Assembly Page



➤ Technical Data Page



➤ Cutting Condition Page



Reaming Tools

TS-REAM

D226

TM-REAM

D228

TB-REAM

D230

Reaming Heads & Blades

D233

Recommended Cutting Conditions (Reaming)

D236

Technical Data

D244

Tailor-made Order Form

D252

Tool Selection Guide

Drilling tools

Series		Indexable drill					
		TOPDRILL		TDRILL		TDEEP	
		TOP 2/3/4/5	TOP-CA	TDR 2/3/4/5	TDR-CA	TRGD/TRGD3	
							
Pages		D16 - D27	D28 - D31	D32 - D44	D45 - D47	D144 - D150	
DC(mm)		Ø12.0 - Ø50.0	Ø51.0 - Ø80.0	Ø12.5 - Ø50.0	Ø51.0 - Ø80.0	Ø14.0 - Ø36.0	
Drilling depth(L/D)		2, 3, 4, 5 x Dc	2, 3, 4 x Dc	2, 3, 4, 5 x Dc	2.5, 3.5 x Dc	10-25 x Dc	
Hole tolerance		IT 11-13	IT 12-13	IT 12-13	IT 12-13	IT 10-11	
Application	General drilling		●	●	●	●	●
	Cross hole drilling		●	●	●	●	○
	Irregular surface drilling		○	○	○	○	
	Interrupted drilling		○	○	○	○	
	Chamfering						
Coolant supply		Internal	Internal	Internal	Internal	Internal	

Tool Selection Guide











Drilling tools

Head changeable drill					Solid carbide drill
<i>DRILLSPEED</i>	<i>DRILLRUSH</i>		<i>MODURDRILL</i>	<i>SPADE RUSH</i>	<i>SOLID3DRILL</i>
3ED	TCD	TCD-M	TNDH-TP/ MDB	LCD	3HD
					
D49 - D50	D51 - D59	D60	D62 - D65	D66 - D68	D69 - D70
Ø15.0 - Ø20.9	Ø6.0 - Ø25.9	M8 - M24 (ISO)	Ø26.0 - Ø50.0	Ø20.0 - Ø41.0	Ø4.0 - Ø12.0
3, 5 x Dc	1.5, 3, 5, 8, 12 x Dc		3, 5 x Dc	3, 5, 8 x Dc	3, 5 x Dc
IT 9-10	IT 9-10	IT 9-10	IT 10-12	IT 9-10	IT 8-10
●	●	●	●	●	●
○	●		●	●	●
		●			
Internal	Internal	Internal	Internal	Internal	Internal

● Recommended, ○ Suitable

Tool Selection Guide

Drilling tools

Series		Solid carbide drill					Multi-function tool
		<i>HDRILL</i>					<i>TOPCAP</i>
		NHD-PE/PI	NHD-KI	SHO 10/15/20	SHO-M	CDF	TCAP
							
Pages		D71 - D82	D83 - D84	D86	D87	D88	D91 - D95
DC(mm)		Ø3.0 - Ø12.0	Ø3.0 - Ø12.0	Ø4.0 - Ø10.0	M4 - M10 (ISO)	Ø3.0 - Ø12.7	Ø8.0 - Ø32.0
Drilling depth(L/D)		3, 5 x Dc	3, 5 x Dc	10, 15, 20 x Dc			2.25, 3 x Dc
Hole tolerance		IT 8-10	IT 8-10	IT 8-10	IT 8-10	IT 8-10	IT 10-12
Application	General drilling		●	●	●	●	●
	Cross hole drilling		●	●	○		
	Irregular surface drilling						●
	Interrupted drilling						
	Chamfering					●	
Coolant supply		External / Internal	Internal	Internal	Internal	External	Internal

● Recommended, ○ Suitable

Tool Selection Guide

Deep drilling tools

Series		Indexable deep drill head				
		<i>TDEEP</i>				
		TBTA3	TBTA5	TBTA7	TBTA9	TBTA-FB
Pages		D99 - D104	D105 - D108	D109 - D111	D112 - D114	D115 - D120
DC(mm)		Ø38.00 - Ø106.99	Ø107.00 - Ø168.99	Ø169.00 - Ø232.99	Ø233.00 - Ø293.99	Ø25.00 - Ø89.00
Drilling depth(L/D)		100 x Dc	100 x Dc	100 x Dc	100 x Dc	100 x Dc
Hole tolerance		IT 10	IT 10	IT 10	IT 10	IT 10
Surface finish		3µm	3µm	3µm	3µm	3µm
Single tube	Outer four thread	●	●	●	●	●
	Inner single thread	●	●	●★	●	●
Double tube	Outer four thread	●	●			●

★ In case of inner single thread connection TBTA7 series can cover up to dia. 245.99mm











Series		Indexable deep drill & boring head		Brazed deep drill head	
		<i>TDEEP</i>			
		TBTA-TR	TBTA-R	BTA-SE/DE	BTS-SE
Pages		D127 - D130	D121 - D126	D131 - D133	D134
DC(mm)		Ø16.00 - Ø40.00	Ø25.00 - Ø110.99	Ø12.60 - Ø65.00	Ø8.00 - Ø20.00
Drilling depth(L/D)		100 x Dc	100 x Dc	100 x Dc	100 x Dc
Hole tolerance		IT 10	IT 7 - IT 9	IT 9	IT 9
Surface finish		3µm	1-2µm	2µm	2µm
Single tube	Outer four thread	●	●	●	●★
	Inner single thread	●	●		
Double tube	Outer four thread	●		●	

★ Two start thread: Diameter 12.60 to 15.59mm

● Recommended

Tool Selection Guide

Reaming tools

Series				Solid reamer	Indexable reamer	
				<i>TSREAM</i>	<i>TMREAM</i>	<i>TBREAM</i>
				TS	TM	TB
						
Pages				D226 - D227	D228 - D229	D230 - D232
DC(mm)				Ø3.000 - Ø12.000	Ø11.501 - Ø32.000	Ø8.000 - Ø32.000
Reaming depth(L/D)				7.5-10 x Dc	3, 5, 8 x Dc	5-9 x Dc
Hole tolerance				IT 7	IT 7 ★	IT 6 ★★
Application		Through	Blind			
	General reaming			●	●	●
	Cross hole reaming			●		●
	Irregular surface reaming			●		●
	Interrupted reaming			●	●	●
Coolant supply				Internal	Internal	Internal











★ Up to IT 6 tolerance

★★ Up to IT 5 tolerance

● Recommended

Tool Selection Guide









Drill inserts

		TOPDRILL		TDRILL	DRILLSPEED	DRILLRUSH	
		SOMT	SPMG / SPGG	3ED-P+	TCD-P/M/K/N	TCD-P+	
Series							
Pages		D152 - D153	D154 - D155	D156 - D157	D158 - D164	D165 - D169	
Size		04/05/06/07/08 09/11/13/15	05/06/07/09 11/12/14	Ø15.0 - Ø20.9	Ø6.0 - Ø25.9	Ø6.0 - Ø25.9	
Chip former		DP, DK, DL, DA	DG, DK, DA	P+	P/M/K/N	P+	
Grades		TT9080, TT9300 TT8020, TT6080 K10	TT9030, TT8020 TT7400, TT6030 K10	TT5130	TT9080 UF10	TT9080	
Application	General drilling		●	●	●	●	●
	Cross hole drilling		●	●	●	●	●
	Irregular surface drilling		○	○	○	○	○
	Interrupted drilling		○	○			
	Chamfering						

● Recommended, ○ Suitable

Tool Selection Guide

Drill inserts

		<i>DRILLRUSH</i>		<i>MODURDRILL</i>	
		TCD-F	AOMT	TCD-P-CO+	SPGX...DW
Series					
Pages		D170 - D171	D172	D173	D173
Size		Ø8.0 - Ø25.5	06 - C45	Ø15.9 - Ø25.9	06/07/09/11/14
Chip former		F	-	P-CO+	DW
Grades		TT9080	TT9080	TT9080	TT9080
Application	General drilling		•	•	•
	Cross hole drilling		•	•	•
	Irregular surface drilling		○	○	○
	Interrupted drilling				
	Chamfering			•	

Tool Selection Guide









Drill inserts

<i>SPADERUSH</i>		<i>DRILLRUSH</i>	<i>TCHAMFER</i>	<i>TOPCAP</i>
LCD-P	LCD-F	CRNG	XCGT	XCGT XCMT
				
D174 - D175	D176 - D177	D172	D178	D179 - D180
Ø20.0 - Ø41.0	Ø20.0 - Ø41.0	08 - 45CD	06/09	04/05/06/07/08 10/13/17
P	F	-	C30/C45/C60	TA/GV/TC
TT9080	TT9080	TT9080	TT9080	TT9080, TT8020, TT9030, K10
●				●
●				
○				
	●		●	

● Recommended, ○ Suitable











Tool Selection Guide

Drill inserts

		<i>TDEEP</i>			
		NPHT NPMT	NPMX TPMX	TOGT	TPMX XPMT
Series					
Pages		D181 - D183	D184	D185	D186
Size		06/07/08/09 /11/13	08/14/17/24/28	07/08/09/10/11 /12/13/14	14/16/17/24
Chip former		R(L)-G... /R(L)-HF...	R-B/R-G	RS/GF	LG/-45
Grades		TT9030, TT9130, TT8125, TT6130, TT5030	TT9030, TT9130, TT8125, TT7200, TT6130, TT6020, TT5100, TT5030	TT9030	TT9030, TT9130, TT6020, TT5100
Application	General drilling		●	●	●
	Cross hole drilling		○	○	○
	Irregular surface drilling				
	Interrupted drilling				
	Chamfering				

Tool Selection Guide

Reamer heads & blades

			<i>TM</i> REAM	<i>TB</i> REAM	
Series			<p style="text-align: center;"><u>TM</u></p> 	<p style="text-align: center;"><u>TB</u></p> 	
Pages			D233 - D234	D235	
Size			Ø11.501 - Ø32.000	1/2/3/4	
Chip former			BL/AS	A06/B06/B12	
Grades			TT9030	TT5030, TT5050	
Application		Through	Blind		
	General reaming			●	●
	Cross hole reaming				
	Irregular surface reaming				
	Interrupted reaming				

● Recommended, ○ Suitable

Grades

Holemaking grades

Grades	ISO	Characteristics & applications
TT6080 PVD carbide	K05 – K25 H05 – H25	<ul style="list-style-type: none"> • General machining for gray and ductile cast iron • Finish and medium machining of hardened steel
TT9300 CVD carbide	P10 – P25	<ul style="list-style-type: none"> • High speed drilling of carbon & alloy steel
TT5130 PVD carbide	P20 – P40 K20 – K40	<ul style="list-style-type: none"> • High speed drilling of carbon & alloy steel
TT9080 PVD carbide	P20 – P40 M20 – M40 S20 – S40	<ul style="list-style-type: none"> • General machining of steel • General machining of stainless steel • General machining of heat-resistant alloy
TT9030 PVD carbide	P20 – P40 M20 – M40 S20 – S40	<ul style="list-style-type: none"> • General machining of steel • General machining of stainless steel • General machining of heat-resistant alloy
TT8020 PVD carbide	P30 – P50 M30 – M50 S30 – S50	<ul style="list-style-type: none"> • Interrupted and rough machining of steel • Interrupted and rough machining of stainless steel • Low speed and interrupted machining of heat-resistant alloy
K10 Uncoated	K05 – K15 N05 – N15 S05 – S15	<ul style="list-style-type: none"> • General machining of cast iron • General machining of aluminum alloys and non-ferrous materials • General machining of heat-resistant alloy
UF1A/UF10 Uncoated	N10 – N25 S10 – S30	<ul style="list-style-type: none"> • General machining of aluminum alloys and non-ferrous materials • General machining of heat-resistant alloy

Selection guide for holemaking grades

For steel

Cutting speed

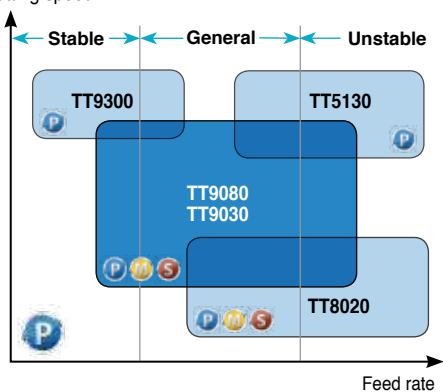

For cast iron

Cutting speed

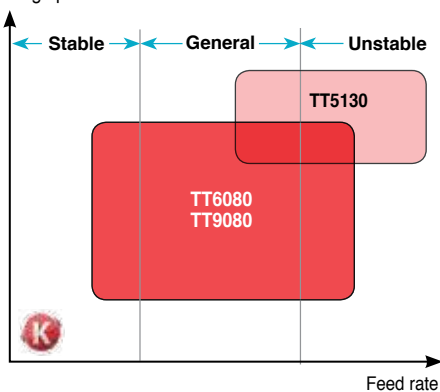

Drilling Tools



Indexable drill holders



• Drilling depth: 2x diameter

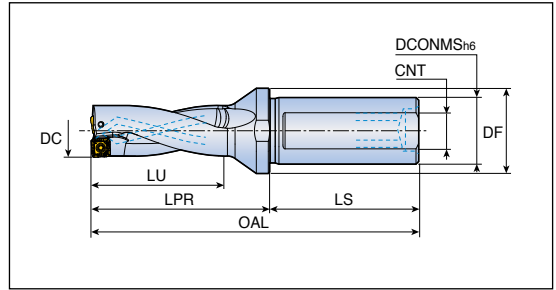

Designation	Dimension (mm)							Insert
	DC	DCONMS	DF	LU	LPR	LS	CNT	
TOP 2120-20T2-04	12.0	20	25	24	44	50	M13X1.0	SOMT 04...DP
2125-20T2-04	12.5	20	25	26	46	50	M13X1.0	D152
2130-20T2-04	13.0	20	25	26	46	50	M13X1.0	
2135-20T2-04	13.5	20	25	28	46	50	M13X1.0	SOMT 05...DP/DL/DK/DA
2140-20T2-05	14.0	20	25	28	46	50	M13X1.0	
2145-20T2-05	14.5	20	25	30	49	50	M13X1.0	
2150-20T2-05	15.0	20	25	30	49	50	M13X1.0	
2155-20T2-05	15.5	20	25	32	52	50	M13X1.0	
2160-20T2-05	16.0	20	25	32	52	50	M13X1.0	SOMT 06...DP/DL/DK/DA
2165-25T2-06	16.5	25	32	34	54	56	M16X1.5	
2170-25T2-06	17.0	25	32	34	54	56	M16X1.5	
2175-25T2-06	17.5	25	32	36	57	56	M16X1.5	
2180-25T2-06	18.0	25	32	36	57	56	M16X1.5	
2185-25T2-06	18.5	25	32	38	59	56	M16X1.5	
2190-25T2-06	19.0	25	32	38	59	56	M16X1.5	
2195-25T2-07	19.5	25	32	40	63	56	M16X1.5	SOMT 07...DP/DL/DK/DA
2200-25T2-07	20.0	25	32	40	63	56	M16X1.5	
2205-25T2-07	20.5	25	32	42	65	56	M16X1.5	
2210-25T2-07	21.0	25	32	42	65	56	M16X1.5	
2215-25T2-07	21.5	25	32	44	67	56	M16X1.5	
2220-25T2-07	22.0	25	32	44	67	56	M16X1.5	
2225-25T2-08	22.5	25	32	46	68	56	M16X1.5	
2230-25T2-08	23.0	25	32	46	68	56	M16X1.5	
2230-32T2-08	23.0	32	40	46	68	60	M22X2.0	
2235-25T2-08	23.5	25	32	48	70	56	M16X1.5	
2235-32T2-08	23.5	32	40	48	70	60	M22X2.0	
2240-25T2-08	24.0	25	32	48	70	56	M16X1.5	SOMT 08...DP/DL/DK/DA
2240-32T2-08	24.0	32	40	48	70	60	M22X2.0	
2245-25T2-08	24.5	25	32	50	72	56	M16X1.5	
2245-32T2-08	24.5	32	40	50	72	60	M22X2.0	
2250-25T2-08	25.0	25	32	50	72	56	M16X1.5	
2250-32T2-08	25.0	32	40	50	72	60	M22X2.0	
2255-25T2-08	25.5	25	32	52	73	56	M16X1.5	
2255-32T2-08	25.5	32	40	52	73	60	M22X2.0	
2260-25T2-08	26.0	25	32	52	73	56	M16X1.5	
2260-32T2-08	26.0	32	40	52	73	60	M22X2.0	

• OAL = LPR + LS



Indexable drill holders

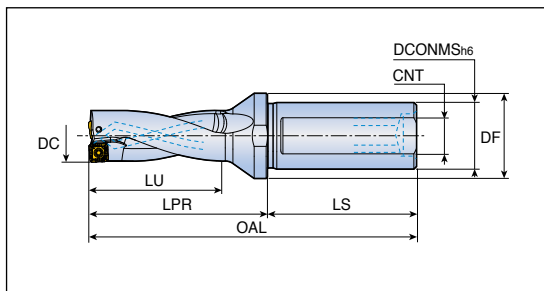

- Drilling depth: 2xdiameter



Designation	Dimension (mm)							Insert
	DC	DCONMS	DF	LU	LPR	LS	CNT	
TOP 2265-32T2-09	26.5	32	40	54	77	60	M22X2.0	SOMT 09...DP/DL/DK/DA D152-153
2270-25T2-09	27.0	25	40	54	77	56	M16X1.5	
2270-32T2-09	27.0	32	40	54	77	60	M22X2.0	
2275-32T2-09	27.5	32	40	56	79	60	M22X2.0	
2280-25T2-09	28.0	25	40	56	79	56	M16X1.5	
2280-32T2-09	28.0	32	40	56	79	60	M22X2.0	
2285-32T2-09	28.5	32	40	58	81	60	M22X2.0	
2290-25T2-09	29.0	25	40	58	81	56	M16X1.5	
2290-32T2-09	29.0	32	40	58	81	60	M22X2.0	
2295-32T2-09	29.5	32	40	60	83	60	M22X2.0	
2300-32T2-09	30.0	32	40	60	83	60	M22X2.0	
2305-32T2-09	30.5	32	40	62	85	60	M22X2.0	
2310-32T2-09	31.0	32	40	62	85	60	M22X2.0	SOMT 11...DP/DL/DK/DA D152-153
2320-32T2-11	32.0	32	40	64	87	60	M22X2.0	
2320-40T2-11	32.0	40	50	64	87	70	M30X2.0	
2330-32T2-11	33.0	32	40	66	89	60	M22X2.0	
2330-40T2-11	33.0	40	50	66	89	70	M30X2.0	
2340-32T2-11	34.0	32	40	68	91	60	M22X2.0	
2340-40T2-11	34.0	40	50	68	91	70	M30X2.0	
2350-32T2-11	35.0	32	40	70	93	60	M22X2.0	
2350-40T2-11	35.0	40	50	70	93	70	M30X2.0	
2360-32T2-11	36.0	32	40	72	95	60	M22X2.0	
2360-40T2-11	36.0	40	50	72	95	70	M30X2.0	
2370-32T2-13	37.0	32	50	74	102	60	M22X2.0	
2370-40T2-13	37.0	40	50	74	102	70	M30X2.0	
2380-32T2-13	38.0	32	50	76	104	60	M22X2.0	
2380-40T2-13	38.0	40	50	76	104	70	M30X2.0	
2390-32T2-13	39.0	32	50	78	106	60	M22X2.0	
2390-40T2-13	39.0	40	50	78	106	70	M30X2.0	
2400-32T2-13	40.0	32	50	80	108	60	M22X2.0	
2400-40T2-13	40.0	40	50	80	108	70	M30X2.0	
2410-40T2-13	41.0	40	50	82	110	70	M30X2.0	
2420-40T2-13	42.0	40	50	84	112	70	M30X2.0	
2430-40T2-13	43.0	40	50	86	114	70	M30X2.0	

- OAL = LPR+LS



TOP 2...-T2

Indexable drill holders



- Drilling depth: 2x diameter

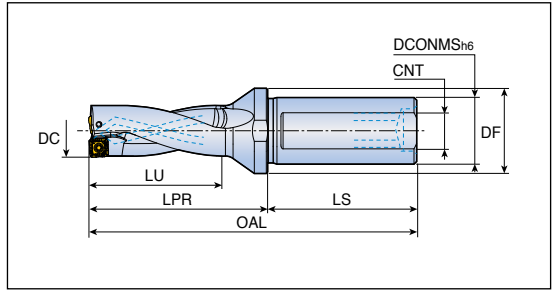

Designation	Dimension (mm)							Insert
	DC	DCONMS	DF	LU	LPR	LS	CNT	
TOP 2440-40T2-15	44.0	40	60	88	123	70	M30X2.0	SOMT 15...DP/DL/DK/DA D152-153
2450-40T2-15	45.0	40	60	90	125	70	M30X2.0	
2460-40T2-15	46.0	40	60	92	127	70	M30X2.0	
2470-40T2-15	47.0	40	60	94	129	70	M30X2.0	
2480-40T2-15	48.0	40	60	96	131	70	M30X2.0	
2490-40T2-15	49.0	40	60	98	133	70	M30X2.0	
2500-40T2-15	50.0	40	60	100	135	70	M30X2.0	

- OAL = LPR+LS

Spare parts

Designation	Screw	Wrench	Plug*	
TOP 2120 - 2135	TS 18041/HG	TD 6P	SL 20M	
TOP 2140 - 2160	TS 20043/HG-P	TD 6P	SL 20M	
TOP 2165 - 2220	TS 22052/HG-P	TD 7P	SL 25M	
TOP 2225 - 2260	SO 25065I	TD 7	SL 25M / SL 32M	
TOP 2265 - 2360	TS 35088I	TD 10	SL 25M / SL 32M / SL 40M	
TOP 2370 - 2430	TS 40093I	TD 15	SL 32M / SL 40M	
TOP 2440 - 2550	TS 50115I	TD 20	SL 40M	



- *Notice: Cooling hole plug for lathe should be ordered separately
Order example) Plug for shank diameter 25.0mm : SL 25M

Indexable drill holders

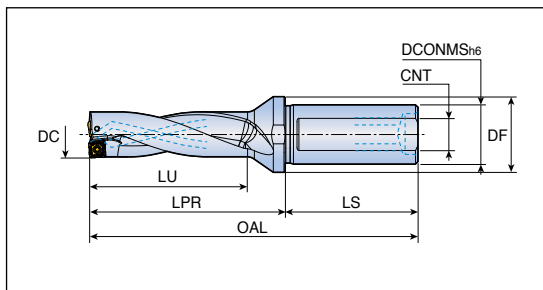

- Drilling depth: 3x diameter



Designation	Dimension (mm)							Insert
	DC	DCONMS	DF	LU	LPR	LS	CNT	
TOP 3120-20T2-04	12.0	20	25	36	56	50	M13X1.0	SOMT 04...DP
3125-20T2-04	12.5	20	25	39	59	50	M13X1.0	D152-153
3130-20T2-04	13.0	20	25	39	59	50	M13X1.0	
3135-20T2-04	13.5	20	25	42	60	50	M13X1.0	SOMT 05...DP/DL/DK/DA
3140-20T2-05	14.0	20	25	42	60	50	M13X1.0	
3145-20T2-05	14.5	20	25	45	64	50	M13X1.0	D152-153
3150-20T2-05	15.0	20	25	45	64	50	M13X1.0	
3155-20T2-05	15.5	20	25	48	68	50	M13X1.0	SOMT 06...DP/DL/DK/DA
3160-20T2-05	16.0	20	25	48	68	50	M13X1.0	
3165-25T2-06	16.5	25	32	51	71	56	M16X1.5	D152-153
3167-25T2-06 *	16.7	25	32	51	71	56	M16X1.5	
3170-25T2-06	17.0	25	32	51	71	56	M16X1.5	SOMT 07...DP/DL/DK/DA
3175-25T2-06	17.5	25	32	54	75	56	M16X1.5	
3180-25T2-06	18.0	25	32	54	75	56	M16X1.5	D152-153
3185-25T2-06	18.5	25	32	57	78	56	M16X1.5	
3190-25T2-06	19.0	25	32	57	78	56	M16X1.5	SOMT 08...DP/DL/DK/DA
3195-25T2-07	19.5	25	32	60	83	56	M16X1.5	
3200-25T2-07	20.0	25	32	60	83	56	M16X1.5	D152-153
3205-25T2-07	20.5	25	32	63	86	56	M16X1.5	
3210-25T2-07	21.0	25	32	63	86	56	M16X1.5	SOMT 09...DP/DL/DK/DA
3215-25T2-07	21.5	25	32	66	89	56	M16X1.5	
3220-25T2-07	22.0	25	32	66	89	56	M16X1.5	D152-153
3222-25T2-07 *	22.2	25	32	66	89	56	M16X1.5	
3225-25T2-08	22.5	25	32	69	91	56	M16X1.5	SOMT 10...DP/DL/DK/DA
3230-25T2-08	23.0	25	32	69	91	56	M16X1.5	
3230-32T2-08	23.0	32	40	69	91	60	M22X2.0	D152-153
3235-25T2-08	23.5	25	32	72	94	56	M16X1.5	
3235-32T2-08	23.5	32	40	72	94	60	M22X2.0	SOMT 11...DP/DL/DK/DA
3240-25T2-08	24.0	25	32	72	94	56	M16X1.5	
3240-32T2-08	24.0	32	40	72	94	60	M22X2.0	D152-153
3245-25T2-08	24.5	25	32	75	97	56	M16X1.5	
3245-32T2-08	24.5	32	40	75	97	60	M22X2.0	SOMT 12...DP/DL/DK/DA
3250-25T2-08	25.0	25	32	75	97	56	M16X1.5	
3250-32T2-08	25.0	32	40	75	97	60	M22X2.0	D152-153
3254-25T2-08 *	25.4	25	32	75	97	56	M16X1.5	



- *! Marked items are for inch sized hole
- OAL = LPR+LS

Indexable drill holders



• Drilling depth: 3x diameter

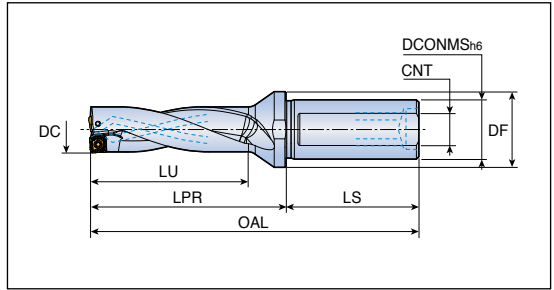

Designation	Dimension (mm)							Insert
	DC	DCONMS	DF	LU	LPR	LS	CNT	
TOP 3255-25T2-08	25.5	25	32	78	99	56	M16X1.5	SOMT 08...DP/DL/DK/DA D152-153
3255-32T2-08	25.5	32	40	78	99	60	M22X2.0	
3260-25T2-08	26.0	25	32	78	99	56	M16X1.5	SOMT 09...DP/DL/DK/DA D152-153
3260-32T2-08	26.0	32	32	78	99	60	M22X2.0	
3265-25T2-09	26.5	25	40	81	104	56	M16X1.5	SOMT 09...DP/DL/DK/DA D152-153
3265-32T2-09	26.5	32	40	81	104	60	M22X2.0	
3270-25T2-09	27.0	25	40	81	104	56	M16X1.5	SOMT 11...DP/DL/DK/DA D152-153
3270-32T2-09	27.0	32	40	81	104	60	M22X2.0	
3275-25T2-09	27.5	25	40	84	107	56	M16X1.5	SOMT 11...DP/DL/DK/DA D152-153
3275-32T2-09	27.5	32	40	84	107	60	M22X2.0	
3280-25T2-09	28.0	25	40	84	107	56	M16X1.5	SOMT 13...DP/DL/DK/DA D152-153
3280-32T2-09	28.0	32	40	84	107	60	M22X2.0	
3285-25T2-09	28.5	25	40	87	110	56	M16X1.5	SOMT 13...DP/DL/DK/DA D152-153
3285-32T2-09	28.5	32	40	87	110	60	M22X2.0	
3290-25T2-09	29.0	25	40	87	110	56	M16X1.5	SOMT 13...DP/DL/DK/DA D152-153
3290-32T2-09	29.0	32	40	87	110	60	M22X2.0	
3295-32T2-09	29.5	32	40	90	113	60	M22X2.0	SOMT 13...DP/DL/DK/DA D152-153
3300-32T2-09	30.0	32	40	90	113	60	M22X2.0	
3305-32T2-09	30.5	32	40	93	116	60	M22X2.0	SOMT 13...DP/DL/DK/DA D152-153
3310-32T2-09	31.0	32	40	93	116	60	M22X2.0	
3320-32T2-11	32.0	32	40	96	119	60	M22X2.0	SOMT 13...DP/DL/DK/DA D152-153
3320-40T2-11	32.0	40	50	96	119	70	M30X2.0	
3330-32T2-11	33.0	32	40	99	122	60	M22X2.0	SOMT 13...DP/DL/DK/DA D152-153
3330-40T2-11	33.0	40	50	99	122	70	M30X2.0	
3340-32T2-11	34.0	32	40	102	125	60	M22X2.0	SOMT 13...DP/DL/DK/DA D152-153
3340-40T2-11	34.0	40	50	102	125	70	M30X2.0	
3350-32T2-11	35.0	32	40	105	128	60	M22X2.0	SOMT 13...DP/DL/DK/DA D152-153
3350-40T2-11	35.0	40	50	105	128	70	M30X2.0	
3360-32T2-11	36.0	32	40	108	131	60	M22X2.0	SOMT 13...DP/DL/DK/DA D152-153
3360-40T2-11	36.0	40	50	108	131	70	M30X2.0	
3370-32T2-13	37.0	32	50	111	139	60	M22X2.0	SOMT 13...DP/DL/DK/DA D152-153
3370-40T2-13	37.0	40	50	111	139	70	M30X2.0	
3380-32T2-13	38.0	32	50	114	142	60	M22X2.0	SOMT 13...DP/DL/DK/DA D152-153
3380-40T2-13	38.0	40	50	114	142	70	M30X2.0	
3390-32T2-13	39.0	32	50	117	145	60	M22X2.0	SOMT 13...DP/DL/DK/DA

• OAL = LPR + LS



Indexable drill holders



- Drilling depth: 3x diameter

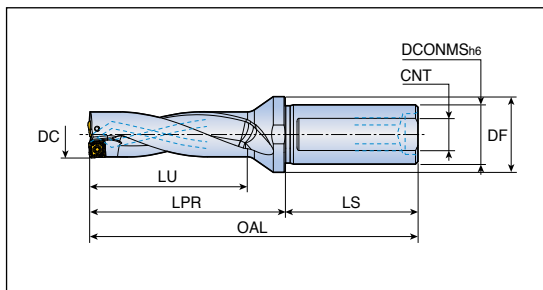

Designation	Dimension (mm)							Insert
	DC	DCONMS	DF	LU	LPR	LS	CNT	
TOP 3390-40T2-13	39.0	40	50	117	145	70	M30X2.0	SOMT 13...DP/DL/DK/DA D152-153
3400-32T2-13	40.0	32	50	120	148	60	M22X2.0	
3400-40T2-13	40.0	40	50	120	148	70	M30X2.0	
3410-40T2-13	41.0	40	50	123	151	70	M30X2.0	
3420-40T2-13	42.0	40	50	126	154	70	M30X2.0	
3430-40T2-13	43.0	40	50	129	157	70	M30X2.0	
3440-40T2-15	44.0	40	60	132	167	70	M30X2.0	SOMT 15...DP/DL/DK/DA D152-153
3450-40T2-15	45.0	40	60	135	170	70	M30X2.0	
3460-40T2-15	46.0	40	60	138	173	70	M30X2.0	
3470-40T2-15	47.0	40	60	141	176	70	M30X2.0	
3480-40T2-15	48.0	40	60	144	179	70	M30X2.0	
3490-40T2-15	49.0	40	60	147	182	70	M30X2.0	
3500-40T2-15	50.0	40	60	150	185	70	M30X2.0	

• OAL = LPR+LS

Spare parts

Designation	Screw	Wrench	Plug*	
TOP 3120 - 3135	TS 18041/HG	TD 6P	SL 20M	
TOP 3140 - 3160	TS 20043I/HG-P	TD 6P	SL 20M	
TOP 3165 - 3220	TS 22052I/HG-P	TD 7P	SL 25M	
TOP 3225 - 3260	SO 25065I	TD 7	SL 25M / SL 32M	
TOP 3265 - 3360	TS 35088I	TD 10	SL 25M / SL 32M / SL 40M	
TOP 3370 - 3430	TS 40093I	TD 15	SL 32M / SL 40M	
TOP 3440 - 3500	TS 50115I	TD 20	SL 40M	

- *Notice: Cooling hole plug for lathe should be ordered separately
Order example) Plug for shank diameter 25.0mm : SL 25M



Indexable drill holders



- Drilling depth: 4x diameter

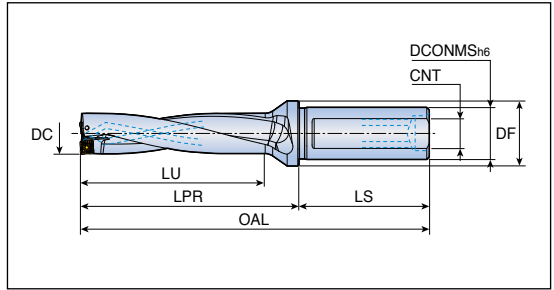

Designation	Dimension (mm)							Insert
	DC	DCONMS	DF	LU	LPR	LS	CNT	
TOP 4120-20T2-04	12.0	20	25	48	68	50	M13X1.0	SOMT 04...DP
4125-20T2-04	12.5	20	25	52	72	50	M13X1.0	D152
4130-20T2-04	13.0	20	25	52	72	50	M13X1.0	
4135-20T2-04	13.5	20	25	56	74	50	M13X1.0	
4140-20T2-05	14.0	20	25	56	74	50	M13X1.0	SOMT 05...DP/DL/DK/DA
4145-20T2-05	14.5	20	25	60	79	50	M13X1.0	D152-153
4150-20T2-05	15.0	20	25	60	79	50	M13X1.0	
4155-20T2-05	15.5	20	25	64	84	50	M13X1.0	
4160-20T2-05	16.0	20	25	64	84	50	M13X1.0	
4165-25T2-06	16.5	25	32	68	88	56	M16X1.5	SOMT 06...DP/DL/DK/DA
4170-25T2-06	17.0	25	32	68	88	56	M16X1.5	D152-153
4175-25T2-06	17.5	25	32	72	93	56	M16X1.5	
4180-25T2-06	18.0	25	32	72	93	56	M16X1.5	
4185-25T2-06	18.5	25	32	76	97	56	M16X1.5	
4190-25T2-06	19.0	25	32	76	97	56	M16X1.5	
4195-25T2-07	19.5	25	32	80	103	56	M16X1.5	SOMT 07...DP/DL/DK/DA
4200-25T2-07	20.0	25	32	80	103	56	M16X1.5	D152-153
4205-25T2-07	20.5	25	32	84	107	56	M16X1.5	
4210-25T2-07	21.0	25	32	84	107	56	M16X1.5	
4215-25T2-07	21.5	25	32	88	111	56	M16X1.5	
4220-25T2-07	22.0	25	32	88	111	56	M16X1.5	
4225-25T2-08	22.5	25	32	92	114	56	M16X1.5	SOMT 08...DP/DL/DK/DA
4230-25T2-08	23.0	25	32	92	114	56	M16X1.5	D152-153
4230-32T2-08	23.0	32	40	92	114	60	M22X2.0	
4235-25T2-08	23.5	25	32	96	118	56	M16X1.5	
4235-32T2-08	23.5	32	40	96	118	60	M22X2.0	
4240-25T2-08	24.0	25	32	96	118	56	M16X1.5	
4240-32T2-08	24.0	32	40	96	118	60	M22X2.0	
4245-25T2-08	24.5	25	32	100	122	56	M16X1.5	
4245-32T2-08	24.5	32	40	100	122	60	M22X2.0	
4250-25T2-08	25.0	25	32	100	122	56	M16X1.5	
4250-32T2-08	25.0	32	40	100	122	60	M22X2.0	
4254-25T2-08 *	25.4	25	32	100	122	56	M16X1.5	
4255-25T2-08	25.5	25	32	104	125	56	M16X1.5	
4255-32T2-08	25.5	32	40	104	125	60	M22X2.0	



- *' Marked items are for inch sized hole
- OAL = LPR+LS

Indexable drill holders



- Drilling depth: 4xdiameter

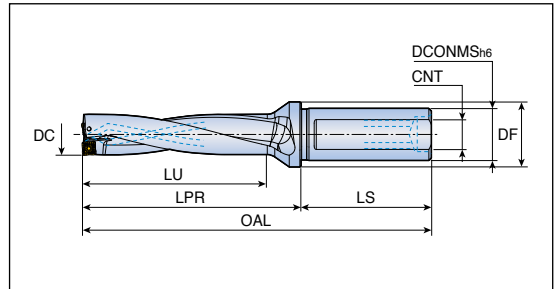

Designation	Dimension (mm)							Insert
	DC	DCONMS	DF	LU	LPR	LS	CNT	
TOP 4260-25T2-08	26.0	25	32	104	125	56	M16X1.5	SOMT 08...DP/DL/DK/DA D152-153
4260-32T2-08	26.0	32	40	104	125	60	M22X2.0	
4265-25T2-09	26.5	25	40	108	131	56	M16X1.5	
4265-32T2-09	26.5	32	40	108	131	60	M22X2.0	
4270-25T2-09	27.0	25	40	108	131	56	M16X1.5	
4270-32T2-09	27.0	32	40	108	131	60	M22X2.0	
4275-25T2-09	27.5	25	40	112	135	56	M16X1.5	
4275-32T2-09	27.5	32	40	112	135	60	M22X2.0	
4280-25T2-09	28.0	25	40	112	135	56	M16X1.5	
4280-32T2-09	28.0	32	40	112	135	60	M22X2.0	
4285-25T2-09	28.5	25	40	116	139	56	M16X1.5	SOMT 09...DP/DL/DK/DA D152-153
4285-32T2-09	28.5	32	40	116	139	60	M22X2.0	
4286-32T2-09 *	28.6	32	40	116	139	60	M22X2.0	
4290-25T2-09	29.0	25	40	116	139	56	M16X1.5	
4290-32T2-09	29.0	32	40	116	139	60	M22X2.0	
4295-32T2-09	29.5	32	40	120	143	60	M22X2.0	
4300-32T2-09	30.0	32	40	120	143	60	M22X2.0	
4305-32T2-09	30.5	32	40	124	147	60	M22X2.0	
4310-32T2-09	31.0	32	40	124	147	60	M22X2.0	
4318-32T2-11 *	31.8	32	40	128	151	60	M22X2.0	
4320-32T2-11	32.0	32	40	128	151	60	M22X2.0	
4320-40T2-11	32.0	40	50	128	151	70	M30X2.0	
4330-32T2-11	33.0	32	40	132	155	60	M22X2.0	
4330-40T2-11	33.0	40	50	132	155	70	M30X2.0	
4340-32T2-11	34.0	32	40	136	159	60	M22X2.0	
4340-40T2-11	34.0	40	50	136	159	70	M30X2.0	
4349-40T2-11 *	34.9	40	50	140	163	70	M30X2.0	
4350-32T2-11	35.0	32	40	140	163	60	M22X2.0	
4350-40T2-11	35.0	40	50	140	163	70	M30X2.0	
4360-32T2-11	36.0	32	40	144	167	60	M22X2.0	SOMT 13...DP/DL/DK/DA D152-153
4360-40T2-11	36.0	40	50	144	167	70	M30X2.0	
4370-32T2-13	37.0	32	50	148	176	60	M22X2.0	
4370-40T2-13	37.0	40	50	148	176	70	M30X2.0	
4371-40T2-13 *	37.1	40	50	148	176	70	M30X2.0	



- '* ' Marked items are for inch sized hole
- OAL = LPR+LS

Indexable drill holders



- Drilling depth: 4x diameter

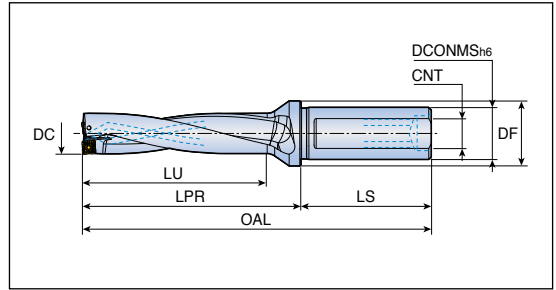

Designation	Dimension (mm)							Insert
	DC	DCONMS	DF	LU	LPR	LS	CNT	
TOP 4380-32T2-13	38.0	32	50	152	180	60	M22X2.0	SOMT 13...DP/DL/DK/DA D152-153
4380-40T2-13	38.0	40	50	152	180	70	M30X2.0	
4381-40T2-13 *	38.1	40	50	152	180	70	M30X2.0	
4390-32T2-13	39.0	32	50	156	184	60	M22X2.0	
4390-40T2-13	39.0	40	50	156	184	70	M30X2.0	
4400-32T2-13	40.0	32	50	160	188	60	M22X2.0	
4400-40T2-13	40.0	40	50	160	188	70	M30X2.0	
4410-40T2-13	41.0	40	50	164	192	70	M30X2.0	
4413-40T2-13 *	41.3	40	50	164	192	70	M30X2.0	
4420-40T2-13	42.0	40	50	168	196	70	M30X2.0	
4429-40T2-13 *	42.9	40	50	172	200	70	M30X2.0	
4430-40T2-13	43.0	40	50	172	200	70	M30X2.0	
4440-40T2-15	44.0	40	60	176	211	70	M30X2.0	
4445-40T2-15 *	44.5	40	60	180	215	70	M30X2.0	
4450-40T2-15	45.0	40	60	180	215	70	M30X2.0	
4460-40T2-15	46.0	40	60	184	219	70	M30X2.0	
4470-40T2-15	47.0	40	60	188	223	70	M30X2.0	
4476-40T2-15 *	47.6	40	60	192	227	70	M30X2.0	
4480-40T2-15	48.0	40	60	192	227	70	M30X2.0	
4490-40T2-15	49.0	40	60	196	231	70	M30X2.0	
4500-40T2-15	50.0	40	60	200	235	70	M30X2.0	
4508-40T2-15 *	50.8	40	60	204	239	70	M30X2.0	

- *' * Marked items are for inch sized hole
- OAL = LPR+LS

Spare parts

Designation	Screw 	Wrench 	Plug* 	
TOP 4120 - 4135	TS 18041/HG	TD 6P	SL 20M	
TOP 4140 - 4160	TS 20043I/HG-P	TD 6P	SL 20M	
TOP 4165 - 4220	TS 22052I/HG-P	TD 7P	SL 25M	
TOP 4225 - 4260	SO 25065I	TD 7	SL 25M / SL 32M	
TOP 4265 - 4360	TS 35088I	TD 10	SL 25M / SL 32M / SL 40M	
TOP 4370 - 4430	TS 40093I	TD 15	SL 32M / SL 40M	
TOP 4440 - 4508	TS 50115I	TD 20	SL 40M	



- *Notice: Cooling hole plug for lathe should be ordered separately
Order example) Plug for shank diameter 25.0mm : SL 25M

Indexable drill holders



- Drilling depth: 5x diameter

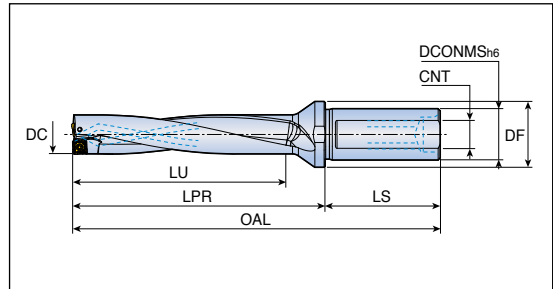

Designation	Dimension (mm)							Insert
	DC	DCONMS	DF	LU	LPR	LS	CNT	
TOP 5120-20T2-04	12.0	20	25	60	80	50	M13X1.0	SOMT 04...DP
5125-20T2-04	12.5	20	25	65	85	50	M13X1.0	D152
5130-20T2-04	13.0	20	25	65	85	50	M13X1.0	
5135-20T2-04	13.5	20	25	70	88	50	M13X1.0	
5140-20T2-05	14.0	20	25	70	88	50	M13X1.0	SOMT 05...DP/DL/DK/DA
5145-20T2-05	14.5	20	25	75	94	50	M13X1.0	D152-153
5150-20T2-05	15.0	20	25	75	94	50	M13X1.0	
5155-20T2-05	15.5	20	25	80	100	50	M13X1.0	
5160-20T2-05	16.0	20	25	80	100	50	M13X1.0	
5165-25T2-06	16.5	25	32	85	105	56	M16X1.5	SOMT 06...DP/DL/DK/DA
5170-25T2-06	17.0	25	32	85	105	56	M16X1.5	D152-153
5175-25T2-06	17.5	25	32	90	111	56	M16X1.5	
5180-25T2-06	18.0	25	32	90	111	56	M16X1.5	
5185-25T2-06	18.5	25	32	95	116	56	M16X1.5	
5190-25T2-06	19.0	25	32	95	116	56	M16X1.5	
5195-25T2-07	19.5	25	32	100	123	56	M16X1.5	SOMT 07...DP/DL/DK/DA
5200-25T2-07	20.0	25	32	100	123	56	M16X1.5	D152-153
5205-25T2-07	20.5	25	32	105	128	56	M16X1.5	
5210-25T2-07	21.0	25	32	105	128	56	M16X1.5	
5215-25T2-07	21.5	25	32	110	133	56	M16X1.5	
5220-25T2-07	22.0	25	32	110	133	56	M16X1.5	
5222-25T2-07 *	22.2	25	32	110	133	56	M16X1.5	
5225-25T2-08	22.5	25	32	115	137	56	M16X1.5	SOMT 08...DP/DL/DK/DA
5230-25T2-08	23.0	25	32	115	137	56	M16X1.5	D152-153
5230-32T2-08	23.0	32	40	115	137	60	M22X2.0	
5235-25T2-08	23.5	25	32	120	142	56	M16X1.5	
5235-32T2-08	23.5	32	40	120	142	60	M22X2.0	
5240-25T2-08	24.0	25	32	120	142	56	M16X1.5	
5240-32T2-08	24.0	32	40	120	142	60	M22X2.0	
5245-25T2-08	24.5	25	32	125	147	56	M16X1.5	
5245-32T2-08	24.5	32	40	125	147	60	M22X2.0	
5250-25T2-08	25.0	25	32	125	147	56	M16X1.5	
5250-32T2-08	25.0	32	40	125	147	60	M22X2.0	
5255-25T2-08	25.5	25	32	130	151	56	M16X1.5	
5255-32T2-08	25.5	32	40	130	151	60	M22X2.0	



- *1 Marked items are for inch sized hole
- OAL = LPR+LS

Indexable drill holders



- Drilling depth: 5x diameter

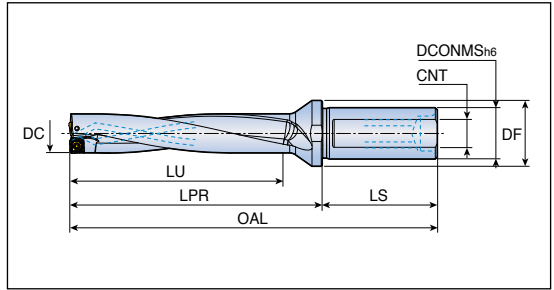

Designation	Dimension (mm)							Insert
	DC	DCONMS	DF	LU	LPR	LS	CNT	
TOP 5260-25T2-08	26.0	25	32	130	151	56	M16X1.5	SOMT 08...DP/DL/DK/DA
5260-32T2-08	26.0	32	40	130	151	60	M22X2.0	D152-153
5265-32T2-09	26.5	32	40	135	158	60	M22X2.0	SOMT 09...DP/DL/DK/DA
5270-25T2-09	27.0	25	40	135	158	56	M16X1.5	D152-153
5270-32T2-09	27.0	32	40	135	158	60	M22X2.0	
5275-32T2-09	27.5	32	40	140	163	60	M22X2.0	
5280-25T2-09	28.0	25	40	140	163	56	M16X1.5	
5280-32T2-09	28.0	32	40	140	163	60	M22X2.0	
5282-32T2-09 *	28.2	32	40	140	163	60	M22X2.0	
5285-32T2-09	28.5	32	40	145	168	60	M22X2.0	
5290-25T2-09	29.0	25	40	145	168	56	M16X1.5	
5290-32T2-09	29.0	32	40	145	168	60	M22X2.0	
5295-32T2-09	29.5	32	40	150	173	60	M22X2.0	
5300-32T2-09	30.0	32	40	150	173	60	M22X2.0	
5305-32T2-09	30.5	32	40	155	178	60	M22X2.0	
5310-32T2-09	31.0	32	40	155	178	60	M22X2.0	
5320-32T2-11	32.0	32	40	160	183	60	M22X2.0	SOMT 11...DP/DL/DK/DA
5320-40T2-11	32.0	40	50	160	183	70	M30X2.0	D152-153
5330-32T2-11	33.0	32	40	165	188	60	M22X2.0	
5330-40T2-11	33.0	40	50	165	188	70	M30X2.0	
5340-32T2-11	34.0	32	40	170	193	60	M22X2.0	
5340-40T2-11	34.0	40	50	170	193	70	M30X2.0	
5350-32T2-11	35.0	32	40	175	198	60	M22X2.0	
5350-40T2-11	35.0	40	50	175	198	70	M30X2.0	
5360-32T2-11	36.0	32	40	180	203	60	M22X2.0	
5360-40T2-11	36.0	40	50	180	203	70	M30X2.0	
5370-32T2-13	37.0	32	50	185	213	60	M22X2.0	SOMT 13...DP/DL/DK/DA
5370-40T2-13	37.0	40	50	185	213	70	M30X2.0	D152-153
5380-32T2-13	38.0	32	50	190	218	60	M22X2.0	
5380-40T2-13	38.0	40	50	190	218	70	M30X2.0	
5390-32T2-13	39.0	32	50	195	223	60	M22X2.0	
5390-40T2-13	39.0	40	50	195	223	70	M30X2.0	
5400-32T2-13	40.0	32	50	200	228	60	M22X2.0	
5400-40T2-13	40.0	40	50	200	228	70	M30X2.0	



- '*1' Marked items are for inch sized hole
- OAL = LPR+LS

Indexable drill holders

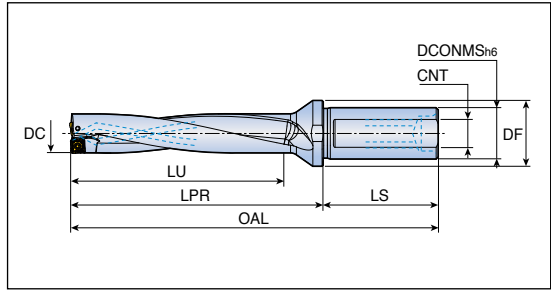

- Drilling depth: 5x diameter



Designation	Dimension (mm)							Insert
	DC	DCONMS	DF	LU	LPR	LS	CNT	
TOP 5410-40T2-13	41.0	40	50	205	233	70	M30X2.0	SOMT 13...DP/DL/DK/DA
5420-40T2-13	42.0	40	50	210	238	70	M30X2.0	D152-153
5430-40T2-13	43.0	40	50	215	243	70	M30X2.0	
5440-40T2-15	44.0	40	60	220	255	70	M30X2.0	SOMT 15...DP/DL/DK/DA
5450-40T2-15	45.0	40	60	225	260	70	M30X2.0	D152-153
5460-40T2-15	46.0	40	60	230	265	70	M30X2.0	
5470-40T2-15	47.0	40	60	235	270	70	M30X2.0	
5480-40T2-15	48.0	40	60	240	275	70	M30X2.0	
5490-40T2-15	49.0	40	60	245	280	70	M30X2.0	
5500-40T2-15	50.0	40	60	250	285	70	M30X2.0	

- OAL = LPR+LS

Spare parts

Designation	Screw 	Wrench 	Plug* 	
TOP 5120 - 5135	TS 18041/HG	TD 6P	SL 20M	
TOP 5140 - 5160	TS 200431/HG-P	TD 6P	SL 20M	
TOP 5165 - 5220	TS 220521/HG-P	TD 7P	SL 25M	
TOP 5225 - 5260	SO 25065I	TD 7	SL 25M / SL 32M	
TOP 5265 - 5360	TS 35088I	TD 10	SL 25M / SL 32M / SL 40M	
TOP 5370 - 5430	TS 40093I	TD 15	SL 32M / SL 40M	
TOP 5440 - 5500	TS 50115I	TD 20	SL 40M	

- *Notice: Cooling hole plug for lathe should be ordered separately
Order example) Plug for shank diameter 25.0mm : SL 25M



Indexable drill holders for cartridge



- Drilling depth: 2x diameter

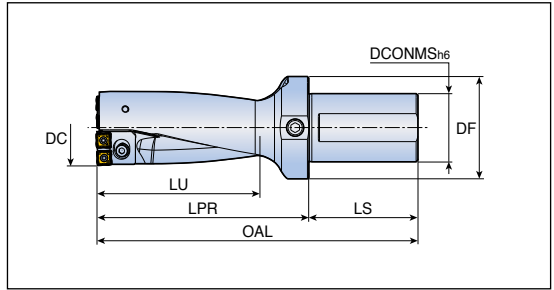

Designation	Dimension (mm)							Setting Plate	Insert
	DC	DCONMS	DF	OAL	LU	LPR	LS		
TOP 2051-55-50T2-09CA	51	50	75	223	110	143	80	-	SOMT 09 ...
	52	50	75	223	110	143	80	TOP-0901	DP/DL/DK/DA
	53	50	75	223	110	143	80	TOP-0902	D152-153
	54	50	75	223	110	143	80	TOP-0903	
	55	50	75	223	110	143	80	TOP-0904	
TOP 2056-60-50T2-11CA	56	50	75	236	120	156	80	-	SOMT 11 ...
	57	50	75	236	120	156	80	TOP-0901	DP/DL/DK/DA
	58	50	75	236	120	156	80	TOP-0902	D152-153
	59	50	75	236	120	156	80	TOP-0903	
	60	50	75	236	120	156	80	TOP-0904	
TOP 2061-65-50T2-11CA	61	50	75	249	130	169	80	-	SOMT 11 ...
	62	50	75	249	130	169	80	TOP-0901	DP/DL/DK/DA
	63	50	75	249	130	169	80	TOP-0902	D152-153
	64	50	75	249	130	169	80	TOP-0903	
	65	50	75	249	130	169	80	TOP-0904	
TOP 2066-70-50T2-11CA	66	50	75	262	140	182	80	-	SOMT 11 ...
	67	50	75	262	140	182	80	TOP-0901	DP/DL/DK/DA
	68	50	75	262	140	182	80	TOP-0902	D152-153
	69	50	75	262	140	182	80	TOP-0903	
	70	50	75	262	140	182	80	TOP-0904	
TOP 2071-75-50T2-13CA	71	50	75	275	150	195	80	-	SOMT 13 ...
	72	50	75	275	150	195	80	TOP-0901	DP/DL/DK/DA
	73	50	75	275	150	195	80	TOP-0902	D152-153
	74	50	75	275	150	195	80	TOP-0903	
	75	50	75	275	150	195	80	TOP-0904	
TOP 2076-80-50T2-13CA	76	50	75	288	160	208	80	-	SOMT 13 ...
	77	50	75	288	160	208	80	TOP-0901	DP/DL/DK/DA
	78	50	75	288	160	208	80	TOP-0902	D152-153
	79	50	75	288	160	208	80	TOP-0903	
	80	50	75	288	160	208	80	TOP-0904	



TOP 30...CA



Indexable drill holders for cartridge



- Drilling depth: 3x diameter

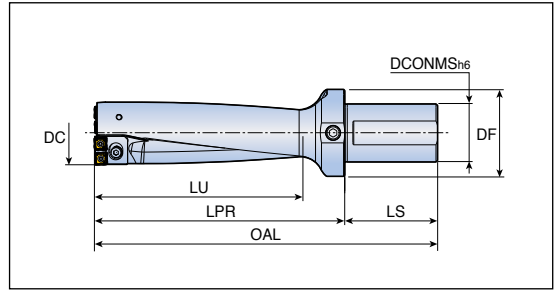

Designation	Dimension (mm)							Setting Plate	Insert
	DC	DCONMS	DF	OAL	LU	LPR	LS		
TOP 3051-55-50T2-09CA	51	50	75	278	165	198	80	-	SOMT 09...
	52	50	75	278	165	198	80	TOP-0901	DP/DL/DK/DA
	53	50	75	278	165	198	80	TOP-0902	D152-153
	54	50	75	278	165	198	80	TOP-0903	
	55	50	75	278	165	198	80	TOP-0904	
TOP 3056-60-50T2-11CA	56	50	75	296	180	216	80	-	SOMT 11...
	57	50	75	296	180	216	80	TOP-0901	DP/DL/DK/DA
	58	50	75	296	180	216	80	TOP-0902	D152-153
	59	50	75	296	180	216	80	TOP-0903	
	60	50	75	296	180	216	80	TOP-0904	
TOP 3061-65-50T2-11CA	61	50	75	314	195	234	80	-	SOMT 11...
	62	50	75	314	195	234	80	TOP-0901	DP/DL/DK/DA
	63	50	75	314	195	234	80	TOP-0902	D152-153
	64	50	75	314	195	234	80	TOP-0903	
	65	50	75	314	195	234	80	TOP-0904	
TOP 3066-70-50T2-11CA	66	50	75	332	210	252	80	-	SOMT 11...
	67	50	75	332	210	252	80	TOP-0901	DP/DL/DK/DA
	68	50	75	332	210	252	80	TOP-0902	D152-153
	69	50	75	332	210	252	80	TOP-0903	
	70	50	75	332	210	252	80	TOP-0904	
TOP 3071-75-50T2-13CA	71	50	75	350	225	270	80	-	SOMT 13...
	72	50	75	350	225	270	80	TOP-0901	DP/DL/DK/DA
	73	50	75	350	225	270	80	TOP-0902	D152-153
	74	50	75	350	225	270	80	TOP-0903	
	75	50	75	350	225	270	80	TOP-0904	
TOP 3076-80-50T2-13CA	76	50	75	368	240	288	80	-	SOMT 13...
	77	50	75	368	240	288	80	TOP-0901	DP/DL/DK/DA
	78	50	75	368	240	288	80	TOP-0902	D152-153
	79	50	75	368	240	288	80	TOP-0903	
	80	50	75	368	240	288	80	TOP-0904	



TOP 40...CA

Indexable drill holders for cartridge



- Drilling depth: 4x diameter

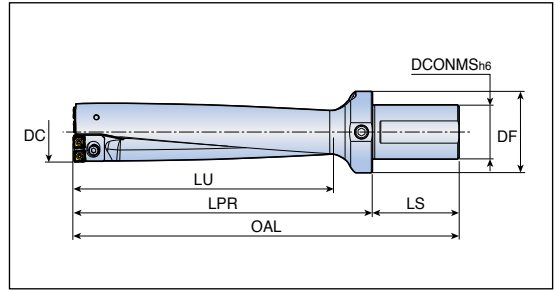



Designation	Dimension (mm)							Setting Plate	Insert
	DC	DCONMS	DF	OAL	LU	LPR	LS		
TOP 4051-55-50T2-09CA	51	50	75	333	220	253	80	-	SOMT 09 ...
	52	50	75	333	220	253	80	TOP-0901	DP/DL/DK/DA
	53	50	75	333	220	253	80	TOP-0902	D152-153
	54	50	75	333	220	253	80	TOP-0903	
	55	50	75	333	220	253	80	TOP-0904	
TOP 4056-60-50T2-11CA	56	50	75	356	240	276	80	-	SOMT 11 ...
	57	50	75	356	240	276	80	TOP-0901	DP/DL/DK/DA
	58	50	75	356	240	276	80	TOP-0902	D152-153
	59	50	75	356	240	276	80	TOP-0903	
	60	50	75	356	240	276	80	TOP-0904	
TOP 4061-65-50T2-11CA	61	50	75	379	260	299	80	-	SOMT 11 ...
	62	50	75	379	260	299	80	TOP-0901	DP/DL/DK/DA
	63	50	75	379	260	299	80	TOP-0902	D152-153
	64	50	75	379	260	299	80	TOP-0903	
	65	50	75	379	260	299	80	TOP-0904	
TOP 4066-70-50T2-11CA	66	50	75	402	280	322	80	-	SOMT 11 ...
	67	50	75	402	280	322	80	TOP-0901	DP/DL/DK/DA
	68	50	75	402	280	322	80	TOP-0902	D152-153
	69	50	75	402	280	322	80	TOP-0903	
	70	50	75	402	280	322	80	TOP-0904	
TOP 4071-75-50T2-13CA	71	50	75	425	300	345	80	-	SOMT 13 ...
	72	50	75	425	300	345	80	TOP-0901	DP/DL/DK/DA
	73	50	75	425	300	345	80	TOP-0902	D152-153
	74	50	75	425	300	345	80	TOP-0903	
	75	50	75	425	300	345	80	TOP-0904	
TOP 4076-80-50T2-13CA	76	50	75	448	320	368	80	-	SOMT 13 ...
	77	50	75	448	320	368	80	TOP-0901	DP/DL/DK/DA
	78	50	75	448	320	368	80	TOP-0902	D152-153
	79	50	75	448	320	368	80	TOP-0903	
	80	50	75	448	320	368	80	TOP-0904	



Indexable drill holders for cartridge

Spare parts

Designation	Screw	Cartridge for peripheral	Cartridge for center
			
TOP ..51-55-50T2-09CA	TS 35088I	TOP 09CA-P1	TOP 09CA-C1
TOP ..56-60-50T2-11CA	TS 35088I	TOP 11CA-P1	TOP 11CA-C1
TOP ..61-65-50T2-11CA	TS 35088I	TOP 11CA-P2	TOP 11CA-C2
TOP ..66-70-50T2-11CA	TS 35088I	TOP 11CA-P3	TOP 11CA-C3
TOP ..71-75-50T2-13CA	TS 40093I	TOP 13CA-P1	TOP 13CA-C1
TOP ..76-80-50T2-13CA	TS 40093I	TOP 13CA-P2	TOP 13CA-C2

Spare parts for cartridge

Designation	Cartridge clamping screw	Washer	Setting plate screw
TOP 09CA-P1	SH M4x0.7x16	MW 4.3x8	TS 20043I/HG-P
TOP 09CA-C1	SH M4x0.7x16	MW 4.3x8	-
TOP 11CA-P1	SH M5x0.8x16	MW 5.5x10	TS 20043I/HG-P
TOP 11CA-C1	SH M5x0.8x16	MW 5.5x10	-
TOP 11CA-P2	SH M5x0.8x16	MW 5.5x10	TS 20043I/HG-P
TOP 11CA-C2	SH M5x0.8x16	MW 5.5x10	-
TOP 11CA-P3	SH M5x0.8x16	MW 5.5x10	TS 20043I/HG-P
TOP 11CA-C3	SH M5x0.8x16	MW 5.5x10	-
TOP 13CA-P1	SH M6x1.0x20	MW 6.4x12	TS 20043I/HG-P
TOP 13CA-C1	SH M6x1.0x20	MW 6.4x12	-
TOP 13CA-P2	SH M6x1.0x20	MW 6.4x12	TS 20043I/HG-P
TOP 13CA-C2	SH M6x1.0x20	MW 6.4x12	-

Indexable drill holders



- Drilling depth: 2x diameter

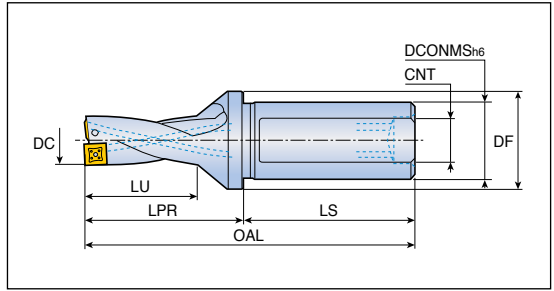

Designation	Dimension (mm)							Insert
	DC	DCONMS	DF	LU	LPR	LS	CNT	
TDR 2125-20T2-05	12.5	20	25	26	44	50	M13X1.0	SPMG 05...
2130-20T2-05	13.0	20	25	26	44	50	M13X1.0	DG/DK
2135-20T2-05	13.5	20	25	28	46	50	M13X1.0	SPGG 05..DA
2140-20T2-05	14.0	20	25	28	46	50	M13X1.0	D154-155
2145-20T2-05	14.5	20	25	30	49	50	M13X1.0	
2150-20T2-05	15.0	20	25	30	49	50	M13X1.0	
2155-25T2-06	15.5	25	32	32	52	56	M16X1.5	SPMG 06...
2160-25T2-06	16.0	25	32	32	52	56	M16X1.5	DG/DK
2165-25T2-06	16.5	25	32	34	54	56	M16X1.5	SPGG 06..DA
2170-25T2-06	17.0	25	32	34	54	56	M16X1.5	D154-155
2175-25T2-06	17.5	25	32	36	57	56	M16X1.5	
2180-25T2-06	18.0	25	32	36	57	56	M16X1.5	
2185-25T2-06	18.5	25	32	38	59	56	M16X1.5	
2190-25T2-06	19.0	25	32	38	59	56	M16X1.5	
2195-25T2-06	19.5	25	32	40	63	56	M16X1.5	
2200-25T2-06	20.0	25	32	40	63	56	M16X1.5	
2205-25T2-06	20.5	25	32	42	65	56	M16X1.5	
2210-25T2-06	21.0	25	32	42	65	56	M16X1.5	
2215-25T2-06	21.5	25	32	44	67	56	M16X1.5	
2220-25T2-07	22.0	25	32	44	67	56	M16X1.5	SPMG 07...
2225-25T2-07	22.5	25	32	46	71	56	M16X1.5	DG/DK
2225-32T2-07	22.5	32	40	46	71	60	M22X2.0	SPGG 07..DA
2230-25T2-07	23.0	25	32	46	71	56	M16X1.5	D154-155
2230-32T2-07	23.0	32	40	46	71	60	M22X2.0	
2235-25T2-07	23.5	25	32	48	74	56	M16X1.5	
2235-32T2-07	23.5	32	40	48	74	60	M22X2.0	
2240-25T2-07	24.0	25	32	48	74	56	M16X1.5	
2240-32T2-07	24.0	32	40	48	74	60	M22X2.0	
2245-25T2-07	24.5	25	32	50	77	56	M16X1.5	
2245-32T2-07	24.5	32	40	50	77	60	M22X2.0	
2250-25T2-07	25.0	25	32	50	77	56	M16X1.5	
2250-32T2-07	25.0	32	40	50	77	60	M22X2.0	
2255-25T2-07	25.5	25	32	52	79	56	M16X1.5	
2255-32T2-07	25.5	32	40	52	79	60	M22X2.0	
2260-25T2-07	26.0	25	32	52	79	56	M16X1.5	

- OAL = LPR+LS



TDR 2...-T2

Indexable drill holders



- Drilling depth: 2x diameter

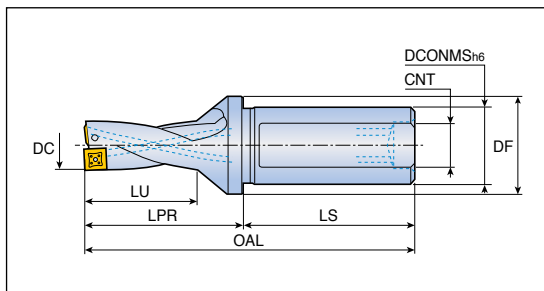

Designation	Dimension (mm)							Insert
	DC	DCONMS	DF	LU	LPR	LS	CNT	
TDR 2260-32T2-07	26.0	32	40	52	79	60	M22X2.0	SPMG 07... DG/DK SPGG 07..DA D154-155
2265-25T2-07	26.5	25	32	54	81	56	M16X1.5	
2265-32T2-07	26.5	32	40	54	81	60	M22X2.0	
2270-25T2-07	27.0	25	32	54	81	56	M16X1.5	
2270-32T2-07	27.0	32	40	54	81	60	M22X2.0	
2275-25T2-07	27.5	25	32	56	84	56	Rc 1/8	
2275-32T2-07	27.5	32	40	56	84	60	Rc 1/4	
2280-25T2-09	28.0	25	40	56	84	56	Rc 1/8	SPMG 09... DG/DK SPGG 09..DA D154-155
2280-32T2-09	28.0	32	40	56	84	60	Rc 1/4	
2285-25T2-09	28.5	25	40	58	86	56	Rc 1/8	
2285-32T2-09	28.5	32	40	58	86	60	Rc 1/4	
2290-25T2-09	29.0	25	40	58	86	56	Rc 1/8	
2290-32T2-09	29.0	32	40	58	86	60	Rc 1/4	
2295-32T2-09	29.5	32	40	60	91	60	Rc 1/4	
2295-40T2-09	29.5	40	50	60	91	70	Rc 1/4	
2300-32T2-09	30.0	32	40	60	91	60	Rc 1/4	
2300-40T2-09	30.0	40	50	60	91	70	Rc 1/4	
2305-32T2-09	30.5	32	40	62	94	60	Rc 1/4	
2305-40T2-09	30.5	40	50	62	94	70	Rc 1/4	
2310-32T2-09	31.0	32	40	62	94	60	Rc 1/4	
2310-40T2-09	31.0	40	50	62	94	70	Rc 1/4	
2315-32T2-09	31.5	32	40	64	96	60	Rc 1/4	
2315-40T2-09	31.5	40	50	64	96	70	Rc 1/4	
2320-32T2-09	32.0	32	40	64	96	60	Rc 1/4	
2320-40T2-09	32.0	40	50	64	96	70	Rc 1/4	
2325-32T2-09	32.5	32	40	66	99	60	Rc 1/4	
2325-40T2-09	32.5	40	50	66	99	70	Rc 1/4	
2330-32T2-09	33.0	32	40	66	99	60	Rc 1/4	
2330-40T2-09	33.0	40	50	66	99	70	Rc 1/4	
2340-32T2-11	34.0	32	50	68	101	60	Rc 1/4	SPMG 11... DG/DK SPGG 11..DA D154-155
2340-40T2-11	34.0	40	55	68	101	70	Rc 1/4	
2350-32T2-11	35.0	32	50	70	104	60	Rc 1/4	
2350-40T2-11	35.0	40	55	70	104	70	Rc 1/4	
2360-32T2-11	36.0	32	50	72	107	60	Rc 1/4	
2360-40T2-11	36.0	40	55	72	107	70	Rc 1/4	

- OAL = LPR+LS



Indexable drill holders



- Drilling depth: 2x diameter

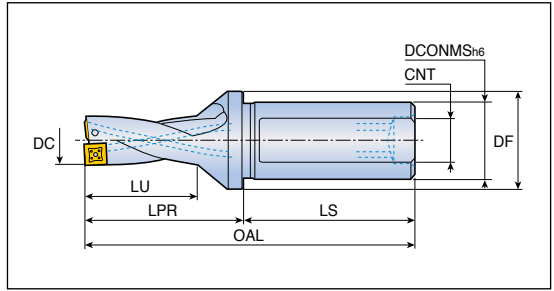

Designation	Dimension (mm)							Insert
	DC	DCONMS	DF	LU	LPR	LS	CNT	
TDR 2370-32T2-11	37.0	32	50	74	110	60	Rc 1/4	SPMG 11... DG/DK SPGG 11..DA D154-155
2370-40T2-11	37.0	40	55	74	110	70	Rc 1/4	
2380-32T2-11	38.0	32	50	76	113	60	Rc 1/4	
2380-40T2-11	38.0	40	55	76	113	70	Rc 1/4	
2390-32T2-11	39.0	32	50	78	115	60	Rc 1/4	
2390-40T2-11	39.0	40	55	78	115	70	Rc 1/4	
2400-32T2-11	40.0	32	50	80	118	60	Rc 1/4	
2400-40T2-11	40.0	40	55	80	118	70	Rc 1/4	
2410-40T2-11	41.0	40	55	82	121	70	Rc 1/4	
2420-40T2-14	42.0	40	60	84	123	70	Rc 1/4	
2430-40T2-14	43.0	40	60	86	126	70	Rc 1/4	
2440-40T2-14	44.0	40	60	88	128	70	Rc 1/4	
2450-40T2-14	45.0	40	60	90	132	70	Rc 1/4	
2460-40T2-14	46.0	40	60	92	135	70	Rc 1/4	
2470-40T2-14	47.0	40	60	94	137	70	Rc 1/4	
2480-40T2-14	48.0	40	60	96	140	70	Rc 1/4	
2490-40T2-14	49.0	40	60	98	142	70	Rc 1/4	
2500-40T2-14	50.0	40	60	100	145	70	Rc 1/4	

- OAL = LPR + LS

Spare parts

Designation	Screw	Wrench	Plug	
TDR 2125 - 2150	TS 20043I/HG-P	TD 6P	SL 20 M	
TDR 2155 - 2215	TS 22052I/HG	TD 7	SL 25 M	
TDR 2220 - 2270	TS 25064I	TD 8	SL 25 M / SL 32 M	
TDR 2275	TS 25064I	TD 8	-	
TDR 2280 - 2330	TS 35088I	TD 10	-	
TDR 2340 - 2390	TS 40093I	TD 15	-	
TDR 2400 - 2410	TS 40093I	TD 15	-	
TDR 2420 - 2500	SO 50090I	TD 20	-	



TDR 3...-T2

Indexable drill holders



- Drilling depth: 3x diameter

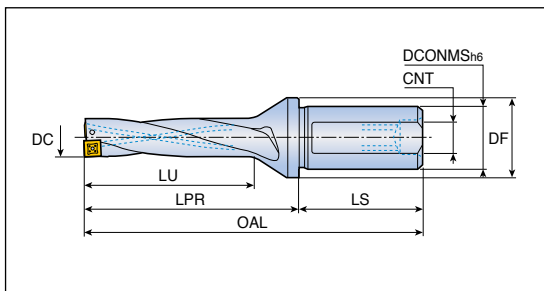

Designation	Dimension (mm)							Insert
	DC	DCONMS	DF	LU	LPR	LS	CNT	
TDR 3125-20T2-05	12.5	20	25	39	57	50	M13X1.0	SPMG 05...
3130-20T2-05	13.0	20	25	39	57	50	M13X1.0	DG/DK
3135-20T2-05	13.5	20	25	42	60	50	M13X1.0	SPGG 05..DA
3140-20T2-05	14.0	20	25	42	60	50	M13X1.0	D154-155
3145-20T2-05	14.5	20	25	45	64	50	M13X1.0	
3150-20T2-05	15.0	20	25	45	64	50	M13X1.0	
3155-25T2-06	15.5	25	32	48	68	56	M16X1.5	SPMG 06...
3160-25T2-06	16.0	25	32	48	68	56	M16X1.5	DG/DK
3165-25T2-06	16.5	25	32	51	71	56	M16X1.5	SPGG 06..DA
3170-25T2-06	17.0	25	32	51	71	56	M16X1.5	D154-155
3175-25T2-06	17.5	25	32	54	75	56	M16X1.5	
3180-25T2-06	18.0	25	32	54	75	56	M16X1.5	
3185-25T2-06	18.5	25	32	57	78	56	M16X1.5	
3190-25T2-06	19.0	25	32	57	78	56	M16X1.5	
3195-25T2-06	19.5	25	32	60	83	56	M16X1.5	
3200-25T2-06 *	20.0	25	32	60	83	56	M16X1.5	
3205-25T2-06	20.5	25	32	63	86	56	M16X1.5	
3209-25T2-06 *	20.9	25	32	63	86	56	M16X1.5	
3210-25T2-06	21.0	25	32	63	86	56	M16X1.5	
3215-25T2-06	21.5	25	32	66	89	56	M16X1.5	
3220-25T2-07	22.0	25	32	66	89	56	M16X1.5	SPMG 07...
3225-25T2-07	22.5	25	32	69	94	56	M16X1.5	DG/DK
3225-32T2-07	22.5	32	40	69	94	60	M22X2.0	SPGG 07..DA
3230-25T2-07	23.0	25	32	69	94	56	M16X1.5	D154-155
3230-32T2-07	23.0	32	40	69	94	60	M22X2.0	
3235-25T2-07	23.5	25	32	72	98	56	M16X1.5	
3235-32T2-07	23.5	32	40	72	98	60	M22X2.0	
3239-25T2-07 *	23.9	25	32	72	98	56	M16X1.5	
3239-32T2-07 *	23.9	32	45	72	98	60	M22X2.0	
3240-25T2-07	24.0	25	32	72	98	56	M16X1.5	
3240-32T2-07	24.0	32	40	72	98	60	M22X2.0	
3245-25T2-07	24.5	25	32	75	102	56	M16X1.5	
3245-32T2-07	24.5	32	40	75	102	60	M22X2.0	
3250-25T2-07	25.0	25	32	75	102	56	M16X1.5	
3250-32T2-07	25.0	32	40	75	102	60	M22X2.0	



- *! Marked items are for pre-thread hole making
- OAL = LPR+LS

Indexable drill holders



- Drilling depth: 3x diameter

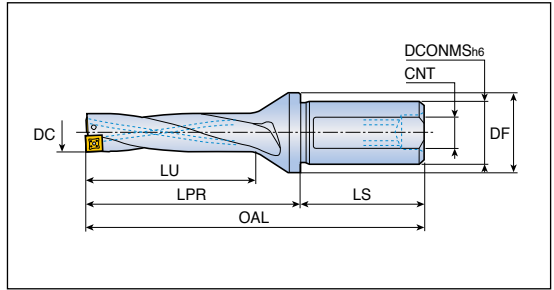

Designation	Dimension (mm)							Insert
	DC	DCONMS	DF	LU	LPR	LS	CNT	
TDR 3255-25T2-07	25.5	25	32	78	105	56	M16X1.5	SPMG 07... DG/DK SPGG 07..DA D154-155
3255-32T2-07	25.5	32	40	78	105	60	M22X2.0	
3260-25T2-07	26.0	25	32	78	105	56	M16X1.5	
3260-32T2-07	26.0	32	40	78	105	60	M22X2.0	
3264-25T2-07 *	26.4	25	45	81	108	56	M16X1.5	
3264-32T2-07 *	26.4	32	45	81	108	60	M22X2.0	
3265-25T2-07	26.5	25	32	81	108	56	M16X1.5	
3265-32T2-07	26.5	32	40	81	108	60	M22X2.0	
3270-25T2-07	27.0	25	32	81	108	56	M16X1.5	
3270-32T2-07	27.0	32	40	81	108	60	M22X2.0	
3275-25T2-07	27.5	25	32	84	112	56	Rc 1/8	SPMG 09... DG/DK SPGG 09..DA D154-155
3275-32T2-07	27.5	32	40	84	112	60	Rc 1/4	
3280-25T2-09	28.0	25	40	84	112	56	Rc 1/8	
3280-32T2-09	28.0	32	40	84	112	60	Rc 1/4	
3285-25T2-09	28.5	25	40	87	115	56	Rc 1/8	
3285-32T2-09	28.5	32	40	87	115	56	Rc 1/4	
3290-25T2-09	29.0	25	40	87	115	56	Rc 1/8	
3290-32T2-09	29.0	32	40	87	115	60	Rc 1/4	
3294-32T2-09 *	29.4	32	55	90	121	60	Rc 1/4	
3294-40T2-09 *	29.4	40	55	90	121	70	Rc 1/4	
3295-32T2-09	29.5	32	40	90	121	60	Rc 1/4	
3295-40T2-09	29.5	40	50	90	121	70	Rc 1/4	
3300-32T2-09	30.0	32	40	90	121	60	Rc 1/4	
3300-40T2-09	30.0	40	50	90	121	70	Rc 1/4	
3305-32T2-09	30.5	32	40	93	125	60	Rc 1/4	
3305-40T2-09	30.5	40	50	93	125	70	Rc 1/4	
3310-32T2-09	31.0	32	40	93	125	60	Rc 1/4	
3310-40T2-09	31.0	40	50	93	125	70	Rc 1/4	
3315-32T2-09	31.5	32	40	96	128	60	Rc 1/4	
3315-40T2-09	31.5	40	50	96	128	70	Rc 1/4	
3320-32T2-09	32.0	32	40	96	128	60	Rc 1/4	
3320-40T2-09	32.0	40	50	96	128	70	Rc 1/4	



- !*! Marked items are for pre-thread hole making
- OAL = LPR + LS

TDR 3...-T2



Indexable drill holders



- Drilling depth: 3x diameter

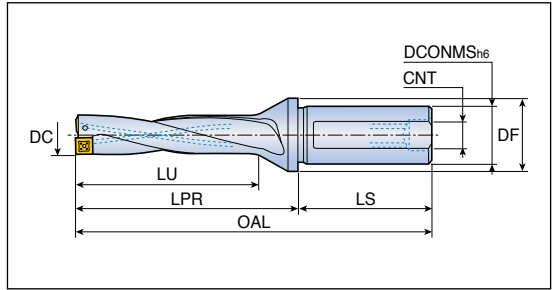

Designation	Dimension (mm)							Insert
	DC	DCONMS	DF	LU	LPR	LS	CNT	
TDR 3420-40T2-14	42.0	40	60	126	165	70	Rc 1/4	SPMG 14...
3430-40T2-14	43.0	40	60	129	169	70	Rc 1/4	DG/DK
3440-40T2-14	44.0	40	60	132	172	70	Rc 1/4	SPGG 14..DA
3450-40T2-14	45.0	40	60	135	177	70	Rc 1/4	D154-155
3460-40T2-14	46.0	40	60	138	181	70	Rc 1/4	
3470-40T2-14	47.0	40	60	141	184	70	Rc 1/4	
3480-40T2-14	48.0	40	60	144	188	70	Rc 1/4	
3490-40T2-14	49.0	40	60	147	191	70	Rc 1/4	
3500-40T2-14	50.0	40	60	150	195	70	Rc 1/4	

- OAL = LPR+LS

Spare parts

Designation	Screw 	Wrench 	Plug 	
TDR 3125 - 3150	TS 20043I/HG-P	TD 6P	SL 20 M	
TDR 3155 - 3215	TS 22052I/HG	TD 7	SL 25 M	
TDR 3220 - 3270	TS 25064I	TD 8	SL 25 M / SL 32 M	
TDR 3275	TS 25064I	TD 8	-	
TDR 3280 - 3330	TS 35088I	TD 10	-	
TDR 3340 - 3390	TS 40093I	TD 15	-	
TDR 3400 - 3410	TS 40093I	TD 15	-	
TDR 3420 - 3500	SO 50090I	TD 20	-	



TDR 4...-T2

Indexable drill holders



- Drilling depth: 4xdiameter

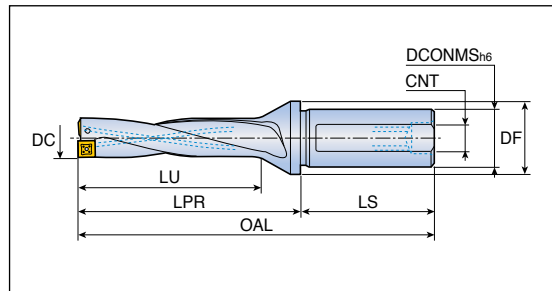

Designation	Dimension (mm)							Insert
	DC	DCONMS	DF	LU	LPR	LS	CNT	
TDR 4125-20T2-05	12.5	20	25	52	70	50	M13X1.0	SPMG 05...
4130-20T2-05	13.0	20	25	52	70	50	M13X1.0	DG/DK
4135-20T2-05	13.5	20	25	56	74	50	M13X1.0	SPGG 05..DA
4140-20T2-05	14.0	20	25	56	74	50	M13X1.0	D154-155
4145-20T2-05	14.5	20	25	60	79	50	M13X1.0	
4150-20T2-05	15.0	20	25	60	79	50	M13X1.0	
4155-25T2-06	15.5	25	32	64	84	56	M16X1.5	SPMG 06...
4160-25T2-06	16.0	25	32	64	84	56	M16X1.5	DG/DK
4165-25T2-06	16.5	25	32	68	88	56	M16X1.5	SPGG 06..DA
4170-25T2-06	17.0	25	32	68	88	56	M16X1.5	D154-155
4175-25T2-06	17.5	25	32	72	93	56	M16X1.5	
4180-25T2-06	18.0	25	32	72	93	56	M16X1.5	
4185-25T2-06	18.5	25	32	76	97	56	M16X1.5	
4190-25T2-06	19.0	25	32	76	97	56	M16X1.5	
4195-25T2-06	19.5	25	32	80	103	56	M16X1.5	
4200-25T2-06	20.0	25	32	80	103	56	M16X1.5	
4205-25T2-06	20.5	25	32	84	107	56	M16X1.5	
4210-25T2-06	21.0	25	32	84	107	56	M16X1.5	
4215-25T2-06	21.5	25	32	88	111	56	M16X1.5	
4220-25T2-07	22.0	25	32	88	111	56	M16X1.5	SPMG 07...
4225-25T2-07	22.5	25	32	92	117	56	M16X1.5	DG/DK
4225-32T2-07	22.5	32	40	92	117	60	M22X2.0	SPGG 07..DA
4230-25T2-07	23.0	25	32	92	117	56	M16X1.5	D154-155
4230-32T2-07	23.0	32	40	92	117	60	M22X2.0	
4235-25T2-07	23.5	25	32	96	122	56	M16X1.5	
4235-32T2-07	23.5	32	40	96	122	60	M22X2.0	
4240-25T2-07	24.0	25	32	96	122	56	M16X1.5	
4240-32T2-07	24.0	32	40	96	122	60	M22X2.0	
4245-25T2-07	24.5	25	32	100	127	56	M16X1.5	
4245-32T2-07	24.5	32	40	100	127	60	M22X2.0	
4250-25T2-07	25.0	25	32	100	127	56	M16X1.5	
4250-32T2-07	25.0	32	40	100	127	60	M22X2.0	
4255-25T2-07	25.5	25	32	104	131	56	M16X1.5	
4255-32T2-07	25.5	32	40	104	131	60	M22X2.0	
4260-25T2-07	26.0	25	32	104	131	56	M16X1.5	

- OAL = LPR+LS



Indexable drill holders



- Drilling depth: 4x diameter

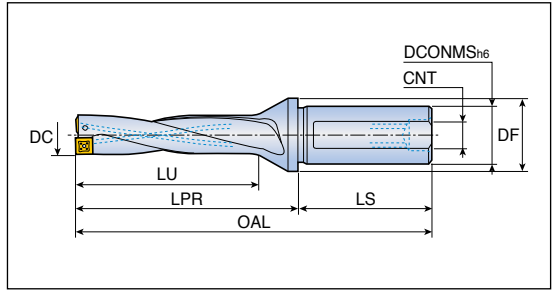

Designation	Dimension (mm)							Insert
	DC	DCONMS	DF	LU	LPR	LS	CNT	
TDR 4260-32T2-07	26.0	32	40	104	131	60	M22X2.0	SPMG 07...
4265-25T2-07	26.5	25	32	108	135	56	M16X1.5	DG/DK
4265-32T2-07	26.5	32	40	108	135	60	M22X2.0	SPGG 07..DA
4270-25T2-07	27.0	25	32	108	135	56	M16X1.5	D154-155
4270-32T2-07	27.0	32	40	108	135	60	M22X2.0	
4275-25T2-07	27.5	25	32	112	140	56	Rc 1/8	
4275-32T2-07	27.5	32	40	112	140	60	Rc 1/4	
4280-25T2-09	28.0	25	40	112	140	56	Rc 1/8	SPMG 09...
4280-32T2-09	28.0	32	40	112	140	60	Rc 1/4	DG/DK
4285-25T2-09	28.5	25	40	116	144	56	Rc 1/8	SPGG 09..DA
4285-32T2-09	28.5	32	40	116	144	60	Rc 1/4	D154-155
4290-25T2-09	29.0	25	40	116	144	56	Rc 1/8	
4290-32T2-09	29.0	32	40	116	144	60	Rc 1/4	
4295-32T2-09	29.5	32	40	120	151	60	Rc 1/4	
4295-40T2-09	29.5	40	50	120	151	70	Rc 1/4	
4300-32T2-09	30.0	32	40	120	151	60	Rc 1/4	
4300-40T2-09	30.0	40	50	120	151	70	Rc 1/4	
4305-32T2-09	30.5	32	40	124	156	60	Rc 1/4	
4305-40T2-09	30.5	40	50	124	156	70	Rc 1/4	
4310-32T2-09	31.0	32	40	124	156	60	Rc 1/4	
4310-40T2-09	31.0	40	50	124	156	70	Rc 1/4	
4315-32T2-09	31.5	32	40	128	160	60	Rc 1/4	
4315-40T2-09	31.5	40	50	128	160	70	Rc 1/4	
4320-32T2-09	32.0	32	40	128	160	60	Rc 1/4	
4320-40T2-09	32.0	40	50	128	160	70	Rc 1/4	
4325-32T2-09	32.5	32	40	132	165	60	Rc 1/4	
4325-40T2-09	32.5	40	50	132	165	70	Rc 1/4	
4330-32T2-09	33.0	32	40	132	165	60	Rc 1/4	
4330-40T2-09	33.0	40	50	132	165	70	Rc 1/4	
4340-32T2-11	34.0	32	50	136	169	60	Rc 1/4	SPMG 11...
4340-40T2-11	34.0	40	55	136	169	70	Rc 1/4	DG/DK
4350-32T2-11	35.0	32	50	140	174	60	Rc 1/4	SPGG 11..DA
4350-40T2-11	35.0	40	55	140	174	70	Rc 1/4	D154-155
4360-32T2-11	36.0	32	50	144	179	60	Rc 1/4	
4360-40T2-11	36.0	40	55	144	179	70	Rc 1/4	

- OAL = LPR+LS



Indexable drill holders



- Drilling depth: 4x diameter

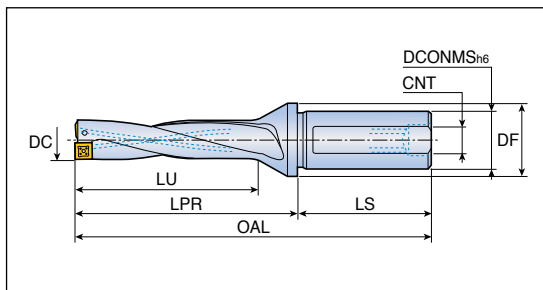

Designation	Dimension (mm)							Insert
	DC	DCONMS	DF	LU	LPR	LS	CNT	
TDR 4370-32T2-11	37.0	32	50	148	184	60	Rc 1/4	SPMG 11... DG/DK SPGG 11..DA D154-155
4370-40T2-11	37.0	40	55	148	184	70	Rc 1/4	
4380-32T2-11	38.0	32	50	152	189	60	Rc 1/4	
4380-40T2-11	38.0	40	55	152	189	70	Rc 1/4	
4390-32T2-11	39.0	32	50	156	193	60	Rc 1/4	
4390-40T2-11	39.0	40	55	156	193	70	Rc 1/4	
4400-32T2-11	40.0	32	50	160	198	60	Rc 1/4	
4400-40T2-11	40.0	40	55	160	198	70	Rc 1/4	
4410-40T2-11	41.0	40	55	164	203	70	Rc 1/4	
4420-40T2-14	42.0	40	60	168	207	70	Rc 1/4	
4430-40T2-14	43.0	40	60	172	212	70	Rc 1/4	
4440-40T2-14	44.0	40	60	176	216	70	Rc 1/4	
4450-40T2-14	45.0	40	60	180	222	70	Rc 1/4	
4460-40T2-14	46.0	40	60	184	227	70	Rc 1/4	
4470-40T2-14	47.0	40	60	188	231	70	Rc 1/4	
4480-40T2-14	48.0	40	60	192	236	70	Rc 1/4	
4490-40T2-14	49.0	40	60	196	240	70	Rc 1/4	
4500-40T2-14	50.0	40	60	200	245	70	Rc 1/4	

- OAL = LPR+LS

Spare parts

Designation	Screw 	Wrench 	Plug 	
TDR 4125 - 4150	TS 20043I/HG-P	TD 6P	SL 20 M	
TDR 4155 - 4215	TS 22052I/HG	TD 7	SL 25 M	
TDR 4220 - 4270	TS 25064I	TD 8	SL 25 M / SL 32 M	
TDR 4275	TS 25064I	TD 8	-	
TDR 4280 - 4330	TS 35088I	TD 10	-	
TDR 4340 - 4390	TS 40093I	TD 15	-	
TDR 4400 - 4410	TS 40093I	TD 15	-	
TDR 4420 - 4500	SO 50090I	TD 20	-	



Indexable drill holders



- Drilling depth: 5x diameter

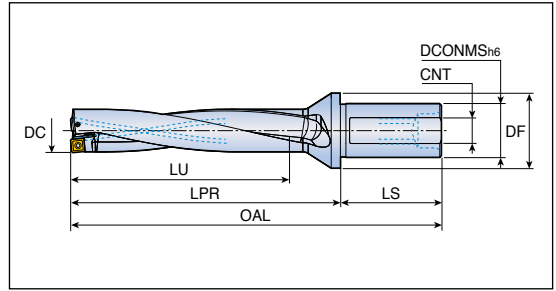

Designation	Dimension (mm)							Insert
	DC	DCONMS	DF	LU	LPR	LS	CNT	
TDR 5125-20T2-05	12.5	20	25	65	83	50	M13X1.0	SPMG 05...
5130-20T2-05	13.0	20	25	65	83	50	M13X1.0	DG/DK
5135-20T2-05	13.5	20	25	70	88	50	M13X1.0	SPGG 05..DA
5140-20T2-05	14.0	20	25	70	88	50	M13X1.0	D154-155
5145-20T2-05	14.5	20	25	75	94	50	M13X1.0	
5150-20T2-05	15.0	20	25	75	94	50	M13X1.0	
5155-25T2-06	15.5	25	32	80	100	56	M16X1.5	SPMG 06...
5160-25T2-06	16.0	25	32	80	100	56	M16X1.5	DG/DK
5165-25T2-06	16.5	25	32	85	105	56	M16X1.5	SPGG 06..DA
5170-25T2-06	17.0	25	32	85	105	56	M16X1.5	D154-155
5175-25T2-06	17.5	25	32	90	111	56	M16X1.5	
5180-25T2-06	18.0	25	32	90	111	56	M16X1.5	
5185-25T2-06	18.5	25	32	95	116	56	M16X1.5	
5190-25T2-06	19.0	25	32	95	116	56	M16X1.5	
5195-25T2-06	19.5	25	32	100	123	56	M16X1.5	
5200-25T2-06	20.0	25	32	100	123	56	M16X1.5	
5205-25T2-06	20.5	25	32	105	128	56	M16X1.5	
5210-25T2-06	21.0	25	32	105	128	56	M16X1.5	
5215-25T2-06	21.5	25	32	110	133	56	M16X1.5	
5220-25T2-07	22.0	25	32	110	133	56	M22X2.0	SPMG 07...
5225-32T2-07	22.5	32	40	115	140	60	M22X2.0	DG/DK
5230-32T2-07	23.0	32	40	115	140	60	M22X2.0	SPGG 07..DA
5235-32T2-07	23.5	32	40	120	146	60	M22X2.0	D154-155
5240-32T2-07	24.0	32	40	120	146	60	M22X2.0	
5245-32T2-07	24.5	32	40	125	152	60	M22X2.0	
5250-32T2-07	25.0	32	40	125	152	60	M22X2.0	
5255-32T2-07	25.5	32	40	130	157	60	M22X2.0	
5260-32T2-07	26.0	32	40	130	157	60	M22X2.0	
5265-32T2-07	26.5	32	40	135	162	60	M22X2.0	
5270-32T2-07	27.0	32	40	135	162	60	M22X2.0	
5275-32T2-07	27.5	32	40	140	168	60	Rc 1/4	

- OAL = LPR+LS



TDR 5...-T2



Indexable drill holders



- Drilling depth: 5x diameter

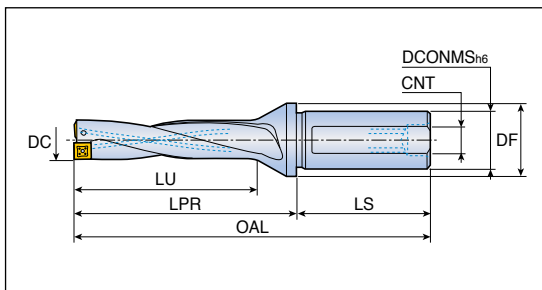

Designation	Dimension (mm)							Insert	
	DC	DCONMS	DF	LU	LPR	LS	CNT		
TDR 5280-32T2-09	28.0	32	40	140	168	60	Rc 1/4	SPMG 09... DG/DK SPGG 09..DA D154-155	
5285-32T2-09	28.5	32	40	145	173	60	Rc 1/4		
5290-32T2-09	29.0	32	40	145	173	60	Rc 1/4		
5295-32T2-09	29.5	32	40	150	181	60	Rc 1/4		
5300-32T2-09	30.0	32	40	150	181	60	Rc 1/4		
5300-40T2-09	30.0	40	50	150	181	70	Rc 1/4		
5310-32T2-09	31.0	32	40	155	187	60	Rc 1/4		
5310-40T2-09	31.0	40	50	155	187	70	Rc 1/4		
5320-32T2-09	32.0	32	40	160	192	60	Rc 1/4		
5320-40T2-09	32.0	40	50	160	192	70	Rc 1/4		
5330-32T2-09	33.0	32	40	165	198	60	Rc 1/4		
5330-40T2-09	33.0	40	50	165	198	70	Rc 1/4		
5340-32T2-11	34.0	32	50	170	203	60	Rc 1/4		SPMG 11... DG/DK SPGG 11..DA D154-155
5340-40T2-11	34.0	40	55	170	203	70	Rc 1/4		
5350-32T2-11	35.0	32	50	175	209	60	Rc 1/4		
5350-40T2-11	35.0	40	55	175	209	70	Rc 1/4		
5360-32T2-11	36.0	32	50	180	215	60	Rc 1/4		
5360-40T2-11	36.0	40	55	180	215	70	Rc 1/4		
5370-32T2-11	37.0	32	50	185	221	60	Rc 1/4		
5370-40T2-11	37.0	40	55	185	221	70	Rc 1/4		
5380-32T2-11	38.0	32	50	190	227	60	Rc 1/4		
5380-40T2-11	38.0	40	55	190	227	70	Rc 1/4		
5390-32T2-11	39.0	32	50	195	232	60	Rc 1/4		
5390-40T2-11	39.0	40	55	195	232	70	Rc 1/4		
5400-32T2-11	40.0	32	50	200	238	60	Rc 1/4		
5400-40T2-11	40.0	40	55	200	238	70	Rc 1/4		
5410-40T2-11	41.0	40	55	205	244	70	Rc 1/4		

• OAL = LPR+LS



TDR 5...-T2



Indexable drill holders



- Drilling depth: 5x diameter

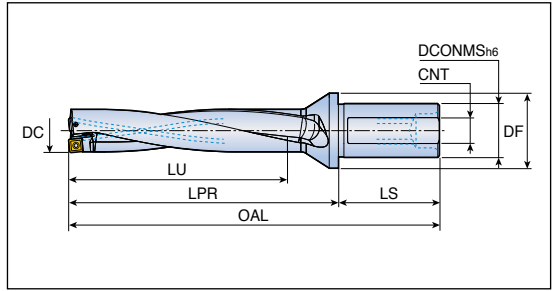

Designation	Dimension (mm)							Insert
	DC	DCONMS	DF	LU	LPR	LS	CNT	
TDR 5420-40T2-14	42.0	40	60	210	249	70	Rc 1/4	SPMG 14... DG/DK SPGG 14..DA D154-155
5430-40T2-14	43.0	40	60	215	255	70	Rc 1/4	
5440-40T2-14	44.0	40	60	220	260	70	Rc 1/4	
5450-40T2-14	45.0	40	60	225	267	70	Rc 1/4	
5460-40T2-14	46.0	40	60	230	273	70	Rc 1/4	
5470-40T2-14	47.0	40	60	235	278	70	Rc 1/4	
5480-40T2-14	48.0	40	60	240	284	70	Rc 1/4	
5490-40T2-14	49.0	40	60	245	289	70	Rc 1/4	
5500-40T2-14	50.0	40	60	250	295	70	Rc 1/4	

- OAL = LPR+LS

Spare parts

Designation	Screw	Wrench	Plug	
TDR 5125 - 5150	TS 20043I/HG-P	TD 6P	SL 20 M	
TDR 5155 - 5215	TS 22052I/HG	TD 7	SL 25 M	
TDR 5220 - 5270	TS 25064I	TD 8	SL 25 M / SL 32 M	
TDR 5275	TS 25064I	TD 8	-	
TDR 5280 - 5330	TS 35088I	TD 10	-	
TDR 5340 - 5390	TS 40093I	TD 15	-	
TDR 5400 - 5410	TS 40093I	TD 15	-	
TDR 5420 - 5500	SO 50090I	TD 20	-	



TDR 25...CA-T



Indexable cartridge drill holders

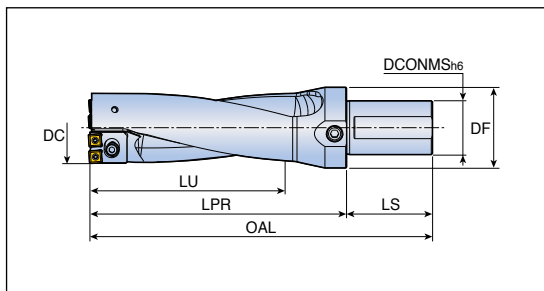

- Drilling depth: 2.5x diameter



Designation	Dimension (mm)						Setting plate	Insert
	DC	DCONMS	DF	LU	LPR	LS		
TDR 2551-53-50T2-07CA-T	51	50	75	133	170	80	-	SPMG 07... DG/DK SPGG 07..DA D154-155
	52	50	75	133	170	80	TDP-0701	
	53	50	75	133	170	80	TDP-0702	
2554-56-50T2-07CA-T	54	50	75	140	180	80	-	SPMG 07... DG/DK SPGG 07..DA D154-155
	55	50	75	140	180	80	TDP-0701	
	56	50	75	140	180	80	TDP-0702	
2557-62-50T2-09CA-T	57	50	75	155	201	80	-	SPMG 09... DG/DK SPGG 09..DA D154-155
	58	50	75	155	201	80	TDP-0901	
	59	50	75	155	201	80	TDP-0902	
	60	50	75	155	201	80	TDP-0903	
	61	50	75	155	201	80	TDP-0904	
	62	50	75	155	201	80	TDP-0905	
2563-66-50T2-09CA-T	63	50	75	165	215	80	-	SPMG 09... DG/DK SPGG 09..DA D154-155
	64	50	75	165	215	80	TDP-0901	
	65	50	75	165	215	80	TDP-0902	
	66	50	75	165	215	80	TDP-0903	
2567-73-50T2-11CA-T	67	50	75	183	240	80	-	SPMG 11... DG/DK SPGG 11..DA D154-155
	68	50	75	183	240	80	TDP-1101	
	69	50	75	183	240	80	TDP-1102	
	70	50	75	183	240	80	TDP-1103	
	71	50	75	183	240	80	TDP-1104	
	72	50	75	183	240	80	TDP-1105	
	73	50	75	183	240	80	TDP-1106	
2574-80-50T2-12CA-T	74	50	75	200	250	80	-	SPMG 12...DG D154
	75	50	75	200	250	80	TDP-1101	
	76	50	75	200	250	80	TDP-1102	
	77	50	75	200	250	80	TDP-1103	
	78	50	75	200	250	80	TDP-1104	
	79	50	75	200	250	80	TDP-1105	
	80	50	75	200	250	80	TDP-1106	



- OAL = LPR+LS

TDR 35...CA-T



Indexable cartridge drill holders



- Drilling depth: 3.5xdiameter

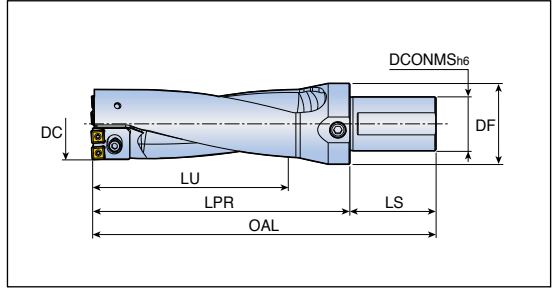

Designation	Dimension (mm)						Setting plate	Insert
	DC	DCONMS	DF	LU	LPR	LS		
TDR 3551-53-50T2-07CA-T	51	50	75	186	223	80	-	SPMG 07...
	52	50	75	186	223	80	TDP-0701	DG/DK SPGG 07..DA
	53	50	75	186	223	80	TDP-0702	SPGG 07..DA D154-155
3554-56-50T2-07CA-T	54	50	75	196	236	80	-	SPMG 07...
	55	50	75	196	236	80	TDP-0701	DG/DK SPGG 07..DA
	56	50	75	196	236	80	TDP-0702	SPGG 07..DA D154-155
3557-62-50T2-09CA-T	57	50	75	217	263	80	-	SPMG 09...
	58	50	75	217	263	80	TDP-0901	DG/DK
	59	50	75	217	263	80	TDP-0902	SPGG 09..DA
	60	50	75	217	263	80	TDP-0903	D154-155
	61	50	75	217	263	80	TDP-0904	
	62	50	75	217	263	80	TDP-0905	
3563-66-50T2-09CA-T	63	50	75	231	281	80	-	SPMG 09...
	64	50	75	231	281	80	TDP-0901	DG/DK
	65	50	75	231	281	80	TDP-0902	SPGG 09..DA
	66	50	75	231	281	80	TDP-0903	D154-155
3567-73-50T2-11CA-T	67	50	75	256	313	80	-	SPMG 11...
	68	50	75	256	313	80	TDP-1101	DG/DK
	69	50	75	256	313	80	TDP-1102	SPGG 11..DA
	70	50	75	256	313	80	TDP-1103	D154-155
	71	50	75	256	313	80	TDP-1104	
	72	50	75	256	313	80	TDP-1105	
	73	50	75	256	313	80	TDP-1106	

- OAL = LPR+LS



Indexable cartridge drill holders



- Drilling depth: 3.5x diameter

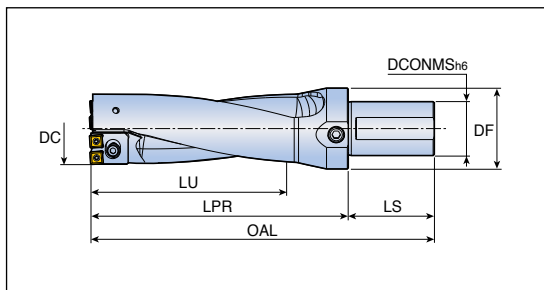

Designation	Dimension (mm)						Setting plate	Insert
	DC	DCONMS	DF	LU	LPR	LS		
TDR 3574-80-50T2-12CA-T	74	50	75	280	330	80	-	SPMG 12...DG D154
	75	50	75	280	330	80	TDP-1101	
	76	50	75	280	330	80	TDP-1102	
	77	50	75	280	330	80	TDP-1103	
	78	50	75	280	330	80	TDP-1104	
	79	50	75	280	330	80	TDP-1105	
80	50	75	280	330	80	TDP-1106		

- OAL = LPR+LS

Spare parts

Designation	Screw	Cartridge for peripheral	Cartridge for center
TDR.. 51-53...	TS 25064I	TDR 07CA-P1-T	TDR 07CA-C1-T
TDR.. 54-56...	TS 25064I	TDR 07CA-P2-T	TDR 07CA-C2-T
TDR.. 57-62...	TS 35088I	TDR 09CA-P1-T	TDR 09CA-C1-T
TDR.. 63-66...	TS 35088I	TDR 09CA-P2-T	TDR 09CA-C2-T
TDR.. 67-73...	TS 40093I	TDR 11CA-P1-T	TDR 11CA-C1-T
TDR.. 74-80...	TS 40093I	TDR 12CA-P2-T	TDR 12CA-C2-T

Spare parts for cartridges

Designation	Cartridge clamping screw	Washer	Setting plate screw
TDR 07CA-P1-T	SH M4x0.7x16	MW 4.3x8	TS 20043I/HG-P
TDR 07CA-C1-T	SH M4x0.7x16	MW 4.3x8	-
TDR 07CA-P2-T	SH M4x0.7x16	MW 4.3x8	TS 20043I/HG-P
TDR 07CA-C2-T	SH M4x0.7x16	MW 4.3x8	-
TDR 09CA-P1-T	SH M5x0.8x16	MW 5.5x10	SO 30055I
TDR 09CA-C1-T	SH M5x0.8x16	MW 5.5x10	-
TDR 09CA-P2-T	SH M5x0.8x16	MW 5.5x10	SO 30055I
TDR 09CA-C2-T	SH M5x0.8x16	MW 5.5x10	-
TDR 11CA-P1-T	SH M6x1.0x20	MW 6.4x12	SO 30055I
TDR 11CA-C1-T	SH M6x1.0x20	MW 6.4x12	-
TDR 12CA-P2-T	SH M6x1.0x20	MW 6.4x12	SO 30055I
TDR 12CA-C2-T	SH M6x1.0x20	MW 6.4x12	-



3ED...T...-3D

Head changeable 3 flute drill holders - Weldon type shank



- Drilling depth: 3xdiameter

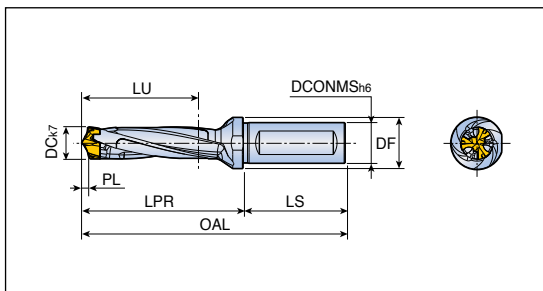

Designation	Dimension (mm)								Clamping key
	DC	DCONMS	DF	LU	LPR	LS	PL	SSC	
3ED 150-159-20T3-3D	15.0-15.9	20	25	49	73.9	50	3.31	15	K 3ED D14-D15
160-169-20T3-3D	16.0-16.9	20	25	52	79.0	50	3.70	16	K 3ED D16-D17
170-179-20T3-3D	17.0-17.9	20	25	55	84.0	50	3.88	17	K 3ED D16-D17
180-189-25T2-3D	18.0-18.9	25	32	58	90.1	56	4.07	18	K 3ED D18-D19
190-199-25T2-3D	19.0-19.9	25	32	61	94.7	56	4.26	19	K 3ED D18-D19
200-209-25T2-3D	20.0-20.9	25	32	64	99.3	56	4.44	20	K 3ED D20-D21

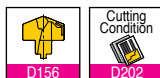

- OAL = LPR+LS
- SSC : Seat size code

3ED...T...-5D

Head changeable 3 flute drill holders - Weldon type shank



- Drilling depth: 5xdiameter

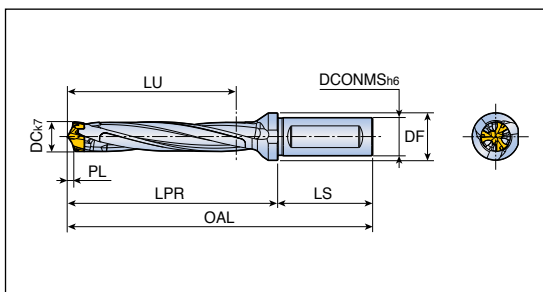

Designation	Dimension (mm)								Clamping key
	DC	DCONMS	DF	LU	LPR	LS	PL	SSC	
3ED 150-159-20T3-5D	15.0-15.9	20	25	79	103.9	50	3.31	15	K 3ED D14-D15
160-169-20T3-5D	16.0-16.9	20	25	84	111.0	50	3.70	16	K 3ED D16-D17
170-179-20T3-5D	17.0-17.9	20	25	89	118.0	50	3.88	17	K 3ED D16-D17
180-189-25T2-5D	18.0-18.9	25	32	94	126.1	56	4.07	18	K 3ED D18-D19
190-199-25T2-5D	19.0-19.9	25	32	99	132.7	56	4.26	19	K 3ED D18-D19
200-209-25T2-5D	20.0-20.9	25	32	104	139.3	56	4.44	20	K 3ED D20-D21

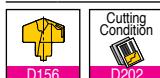

- OAL = LPR+LS
- SSC : Seat size code

3ED...T0...-3D

Head changeable 3 flute drill holders - Cylindrical type shank



- Drilling depth: 3x diameter

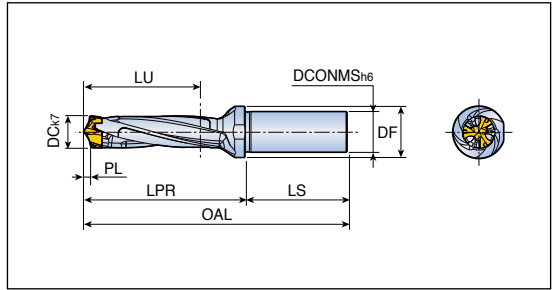

Designation	Dimension (mm)								Clamping key
	DC	DCONMS	DF	LU	LPR	LS	PL	SSC	
3ED 150-159-20T0-3D	15.0-15.9	20	25	49	73.9	50	3.31	15	K 3ED D14-D15
160-169-20T0-3D	16.0-16.9	20	25	52	79.0	50	3.70	16	K 3ED D16-D17
170-179-20T0-3D	17.0-17.9	20	25	55	84.0	50	3.88	17	K 3ED D16-D17
180-189-25T0-3D	18.0-18.9	25	32	58	90.1	56	4.07	18	K 3ED D18-D19
190-199-25T0-3D	19.0-19.9	25	32	61	94.7	56	4.26	19	K 3ED D18-D19
200-209-25T0-3D	20.0-20.9	25	32	64	99.3	56	4.44	20	K 3ED D20-D21

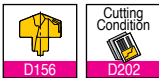

- OAL = LPR+LS
- SSC : Seat size code

3ED...T0...-5D

Head changeable 3 flute drill holders - Cylindrical type shank



- Drilling depth: 5x diameter

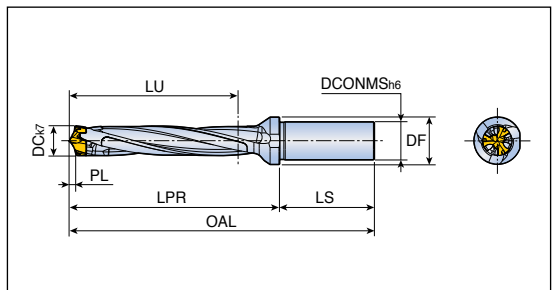

Designation	Dimension (mm)								Clamping key
	DC	DCONMS	DF	LU	LPR	LS	PL	SSC	
3ED 150-159-20T0-5D	15.0-15.9	20	25	79	103.9	50	3.31	15	K 3ED D14-D15
160-169-20T0-5D	16.0-16.9	20	25	84	111.0	50	3.70	16	K 3ED D16-D17
170-179-20T0-5D	17.0-17.9	20	25	89	118.0	50	3.88	17	K 3ED D16-D17
180-189-25T0-5D	18.0-18.9	25	32	94	126.1	56	4.07	18	K 3ED D18-D19
190-199-25T0-5D	19.0-19.9	25	32	99	132.7	56	4.26	19	K 3ED D18-D19
200-209-25T0-5D	20.0-20.9	25	32	104	139.3	56	4.44	20	K 3ED D20-D21

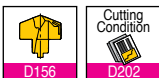

- OAL = LPR+LS
- SSC : Seat size code

TCD...T...-1.5D



Head changeable drill holders - Weldon type shank



- Drilling depth: 1.5xdiameter

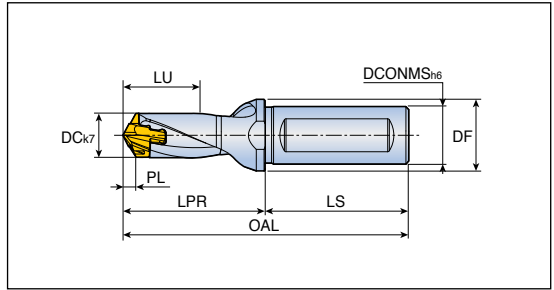

Designation	Dimension (mm)								Clamping key	
	DC	DCONMS	DF	LU	LPR	LS	PL	SSC		
TCD 060-064-12T3-1.5D	6.0-6.4	12	16	10	23.0	45	0.96	6	K TCD D060-D099	
065-069-12T3-1.5D	6.5-6.9	12	16	11	24.1	45	1.18	6.5		
070-074-12T3-1.5D	7.0-7.4	12	16	12	25.1	45	1.01	7		
075-079-12T3-1.5D	7.5-7.9	12	16	12	25.9	45	1.10	7		
080-089-12T3-1.5D	8.0-8.9	12	16	13	27.4	45	1.20	8		
090-099-12T3-1.5D	9.0-9.9	12	16	15	29.3	45	1.35	9		
100-109-16T3-1.5D	10.0-10.9	16	20	17	31.2	48	1.50	10		K TCD D100-D199
110-119-16T3-1.5D	11.0-11.9	16	20	19	33.1	48	1.67	11		
120-129-16T3-1.5D	12.0-12.9	16	20	20	35.0	48	1.82	12		
130-139-16T3-1.5D	13.0-13.9	16	20	22	37.1	48	1.96	13		
140-149-16T3-1.5D	14.0-14.9	16	20	23	41.1	48	2.12	14		
150-159-20T3-1.5D	15.0-15.9	20	25	25	46.2	50	2.27	15		
160-169-20T3-1.5D	16.0-16.9	20	25	26	49.3	50	2.42	16		
170-179-20T3-1.5D	17.0-17.9	20	25	29	52.4	50	2.59	17		
180-189-25T2-1.5D	18.0-18.9	25	32	30	55.5	56	2.73	18		
190-199-25T2-1.5D	19.0-19.9	25	32	32	58.5	56	2.88	19	K TCD D200-D269	
200-209-25T2-1.5D	20.0-20.9	25	32	33	61.6	56	3.02	20		
210-219-25T2-1.5D	21.0-21.9	25	32	35	64.7	56	3.18	21		
220-229-25T2-1.5D	22.0-22.9	25	32	36	67.8	56	3.24	22		
230-239-32T2-1.5D	23.0-23.9	32	42	38	70.8	60	3.46	23		
240-249-32T2-1.5D	24.0-24.9	32	42	40	73.9	60	3.62	24		
250-259-32T2-1.5D	25.0-25.9	32	42	42	77.0	60	3.80	25		

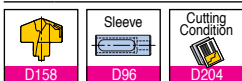

- OAL = LPR+LS
- SSC : Seat size code

TCD...T...-3D

Head changeable drill holders - Weldon type shank

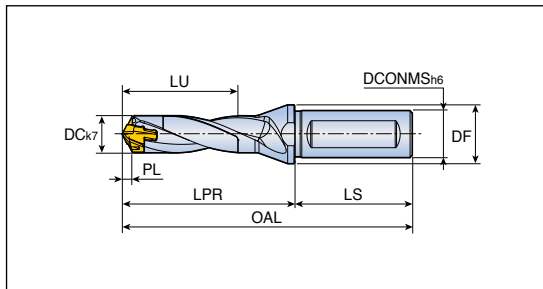

- Drilling depth: 3xdiameter



Designation	Dimension (mm)								Clamping key	
	DC	DCONMS	DF	LU	LPR	LS	PL	SSC		
TCD 060-064-12T3-3D	6.0-6.4	12	16	19	32.0	45	0.96	6	K TCD D060-D099	
065-069-12T3-3D	6.5-6.9	12	16	21	33.8	45	1.18	6.5		
070-074-12T3-3D	7.0-7.4	12	16	22	35.6	45	1.01	7		
075-079-12T3-3D	7.5-7.9	12	16	24	37.1	45	1.10	7		
080-084-12T3-3D	8.0-8.4	12	16	25	39.4	45	1.20	8		
085-089-12T3-3D	8.5-8.9	12	16	27	40.9	45	1.29	8		
090-094-12T3-3D	9.0-9.4	12	16	28	42.8	45	1.35	9		
095-099-12T3-3D	9.5-9.9	12	16	30	44.3	45	1.44	9		
100-104-16T3-3D	10.0-10.4	16	20	32	46.2	48	1.50	10		K TCD D100-D199
105-109-16T3-3D	10.5-10.9	16	20	34	47.7	48	1.59	10		
110-114-16T3-3D	11.0-11.4	16	20	35	49.6	48	1.67	11		
115-119-16T3-3D	11.5-11.9	16	20	37	51.1	48	1.76	11		
120-124-16T3-3D	12.0-12.4	16	20	38	53.0	48	1.82	12		
125-129-16T3-3D	12.5-12.9	16	20	39	54.5	48	1.91	12		
130-134-16T3-3D	13.0-13.4	16	20	41	56.6	48	1.96	13		
135-139-16T3-3D	13.5-13.9	16	20	43	58.1	48	2.05	13		
140-144-16T3-3D	14.0-14.4	16	20	44	62.2	48	2.12	14		
145-149-16T3-3D	14.5-14.9	16	20	46	63.7	48	2.21	14		
150-159-20T3-3D	15.0-15.9	20	25	47	68.7	50	2.27	15	K TCD D200-D269	
160-169-20T3-3D	16.0-16.9	20	25	50	73.3	50	2.42	16		
170-179-20T3-3D	17.0-17.9	20	25	54	77.9	50	2.59	17		
180-189-25T2-3D	18.0-18.9	25	32	57	82.5	56	2.73	18		
190-199-25T2-3D	19.0-19.9	25	32	60	87.0	56	2.88	19		
200-209-25T2-3D	20.0-20.9	25	32	63	91.6	56	3.02	20		
210-219-25T2-3D	21.0-21.9	25	32	66	96.2	56	3.18	21		
220-229-25T2-3D	22.0-22.9	25	32	69	100.8	56	3.24	22		
230-239-32T2-3D	23.0-23.9	32	42	72	105.3	60	3.46	23		
240-249-32T2-3D	24.0-24.9	32	42	76	109.9	60	3.62	24		
250-259-32T2-3D	25.0-25.9	32	42	79	114.5	60	3.80	25		

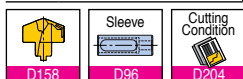

- OAL = LPR+LS
- SSC : Seat size code

TCD...S0-3D

Head changeable drill holders - Cylindrical type shank



- Drilling depth: 3x diameter

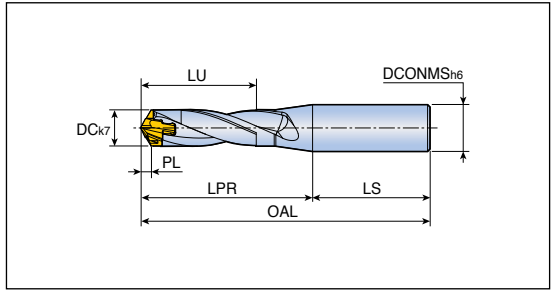

Designation	Dimension (mm)							Clamping key	
	DC	DCONMS	LU	LPR	LS	PL	SSC		
TCD 060-064-12S0-3D	6.0-6.4	12	19	32.0	45	0.96	6	K TCD D060-D099	
065-069-12S0-3D	6.5-6.9	12	21	33.8	45	1.18	6.5		
070-074-12S0-3D	7.0-7.4	12	22	35.6	45	1.01	7		
075-079-12S0-3D	7.5-7.9	12	24	37.1	45	1.10	7		
080-084-12S0-3D	8.0-8.4	12	25	39.4	45	1.20	8		
085-089-12S0-3D	8.5-8.9	12	27	40.9	45	1.29	8		
090-094-12S0-3D	9.0-9.4	12	28	42.8	45	1.35	9		
095-099-12S0-3D	9.5-9.9	12	30	44.3	45	1.44	9		
100-104-16S0-3D	10.0-10.4	16	32	46.2	48	1.50	10		K TCD D100-D199
105-109-16S0-3D	10.5-10.9	16	34	47.7	48	1.59	10		
110-114-16S0-3D	11.0-11.4	16	35	49.6	48	1.67	11		
115-119-16S0-3D	11.5-11.9	16	37	51.1	48	1.76	11		
120-124-16S0-3D	12.0-12.4	16	38	53.0	48	1.82	12		
125-129-16S0-3D	12.5-12.9	16	39	54.5	48	1.91	12		
130-134-16S0-3D	13.0-13.4	16	41	56.6	48	1.96	13		
135-139-16S0-3D	13.5-13.9	16	43	58.1	48	2.05	13		
140-144-16S0-3D	14.0-14.4	16	44	62.1	48	2.12	14		
145-149-16S0-3D	14.5-14.9	16	46	63.7	48	2.21	14		
150-159-20S0-3D	15.0-15.9	20	47	68.7	50	2.27	15	K TCD D200-D269	
160-169-20S0-3D	16.0-16.9	20	50	73.3	50	2.42	16		
170-179-20S0-3D	17.0-17.9	20	54	77.9	50	2.59	17		
180-189-25S0-3D	18.0-18.9	25	57	82.5	56	2.73	18		
190-199-25S0-3D	19.0-19.9	25	60	87.0	56	2.88	19		
200-209-25S0-3D	20.0-20.9	25	63	91.6	56	3.02	20		
210-219-25S0-3D	21.0-21.9	25	66	96.2	56	3.18	21		
220-229-25S0-3D	22.0-22.9	25	69	100.8	56	3.24	22		
230-239-32S0-3D	23.0-23.9	32	72	105.3	60	3.46	23		
240-249-32S0-3D	24.0-24.9	32	76	109.9	60	3.62	24		
250-259-32S0-3D	25.0-25.9	32	79	114.5	60	3.80	25		

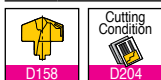

- OAL = LPR+LS
- SSC : Seat size code

TCD...T...-5D

Head changeable drill holders - Weldon type shank



- Drilling depth: 5x diameter

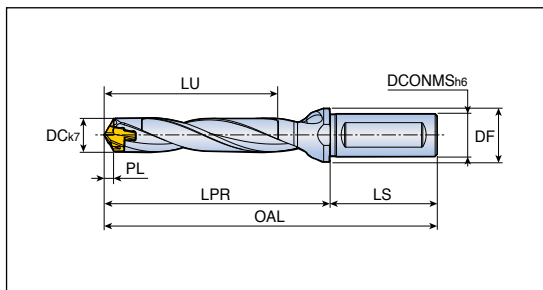

Designation	Dimension (mm)								Clamping key	
	DC	DCONMS	DF	LU	LPR	LS	PL	SSC		
TCD 060-064-12T3-5D	6.0-6.4	12	16	31	44.0	45	0.96	6	K TCD D060-D099	
065-069-12T3-5D	6.5-6.9	12	16	34	46.8	45	1.18	6.5		
070-074-12T3-5D	7.0-7.4	12	16	36	49.6	45	1.01	7		
075-079-12T3-5D	7.5-7.9	12	16	39	52.1	45	1.10	7		
080-084-12T3-5D	8.0-8.4	12	16	41	55.4	45	1.20	8		
085-089-12T3-5D	8.5-8.9	12	16	44	57.9	45	1.29	8		
090-094-12T3-5D	9.0-9.4	12	16	46	60.8	45	1.35	9		
095-099-12T3-5D	9.5-9.9	12	16	49	63.3	45	1.44	9		
100-104-16T3-5D	10.0-10.4	16	20	52	66.2	48	1.50	10		K TCD D100-D199
105-109-16T3-5D	10.5-10.9	16	20	55	68.7	48	1.59	10		
110-114-16T3-5D	11.0-11.4	16	20	57	71.6	48	1.67	11		
115-119-16T3-5D	11.5-11.9	16	20	60	74.1	48	1.76	11		
120-124-16T3-5D	12.0-12.4	16	20	62	77.0	48	1.82	12		
125-129-16T3-5D	12.5-12.9	16	20	64	79.5	48	1.91	12		
130-134-16T3-5D	13.0-13.4	16	20	67	82.6	48	1.96	13		
135-139-16T3-5D	13.5-13.9	16	20	70	85.1	48	2.05	13		
140-144-16T3-5D	14.0-14.4	16	20	72	90.2	48	2.12	14		
145-149-16T3-5D	14.5-14.9	16	20	75	92.7	48	2.21	14		
150-159-20T3-5D	15.0-15.9	20	25	77	98.7	50	2.27	15	K TCD D200-D269	
160-169-20T3-5D	16.0-16.9	20	25	82	105.3	50	2.42	16		
170-179-20T3-5D	17.0-17.9	20	25	88	111.9	50	2.59	17		
180-189-25T2-5D	18.0-18.9	25	32	93	118.5	56	2.73	18		
190-199-25T2-5D	19.0-19.9	25	32	98	125.0	56	2.88	19		
200-209-25T2-5D	20.0-20.9	25	32	103	131.6	56	3.02	20		
210-219-25T2-5D	21.0-21.9	25	32	108	138.2	56	3.18	21		
220-229-25T2-5D	22.0-22.9	25	32	113	144.8	56	3.24	22		
230-239-32T2-5D	23.0-23.9	32	42	118	151.3	60	3.46	23		
240-249-32T2-5D	24.0-24.9	32	42	124	157.9	60	3.62	24		
250-259-32T2-5D	25.0-25.9	32	42	129	164.5	60	3.80	25		

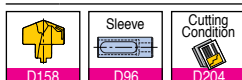

- OAL = LPR+LS
- SSC : Seat size code

TCD...S0-5D



Head changeable drill holders - Cylindrical type shank



- Drilling depth: 5x diameter

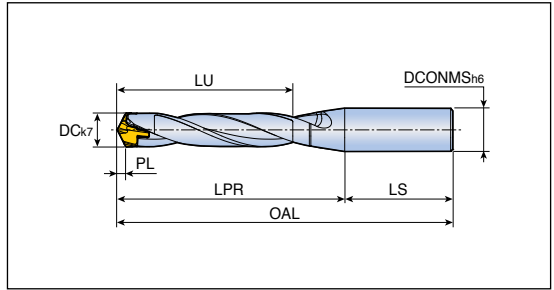

Designation	Dimension (mm)							Clamping key	
	DC	DCONMS	LU	LPR	LS	PL	SSC		
TCD 060-064-12S0-5D	6.0-6.4	12	31	44.0	45	0.96	6	K TCD D060-D099	
065-069-12S0-5D	6.5-6.9	12	34	46.8	45	1.18	6.5		
070-074-12S0-5D	7.0-7.4	12	36	49.6	45	1.01	7		
075-079-12S0-5D	7.5-7.9	12	39	52.1	45	1.10	7		
080-084-12S0-5D	8.0-8.4	12	41	55.4	45	1.20	8		
085-089-12S0-5D	8.5-8.9	12	44	57.9	45	1.29	8		
090-094-12S0-5D	9.0-9.4	12	46	60.8	45	1.35	9		
095-099-12S0-5D	9.5-9.9	12	49	63.3	45	1.44	9		
100-104-16S0-5D	10.0-10.4	16	52	66.2	48	1.50	10		K TCD D100-D199
105-109-16S0-5D	10.5-10.9	16	55	68.7	48	1.59	10		
110-114-16S0-5D	11.0-11.4	16	57	71.6	48	1.67	11		
115-119-16S0-5D	11.5-11.9	16	60	74.1	48	1.76	11		
120-124-16S0-5D	12.0-12.4	16	62	77.0	48	1.82	12		
125-129-16S0-5D	12.5-12.9	16	64	79.5	48	1.91	12		
130-134-16S0-5D	13.0-13.4	16	67	82.6	48	1.96	13		
135-139-16S0-5D	13.5-13.9	16	70	85.1	48	2.05	13		
140-144-16S0-5D	14.0-14.4	16	72	90.2	48	2.12	14		
145-149-16S0-5D	14.5-14.9	16	75	92.7	48	2.21	14		
150-159-20S0-5D	15.0-15.9	20	77	98.7	50	2.27	15	K TCD D200-D269	
160-169-20S0-5D	16.0-16.9	20	82	105.3	50	2.42	16		
170-179-20S0-5D	17.0-17.9	20	88	111.9	50	2.59	17		
180-189-25S0-5D	18.0-18.9	25	93	118.5	56	2.73	18		
190-199-25S0-5D	19.0-19.9	25	98	125.0	56	2.88	19		
200-209-25S0-5D	20.0-20.9	25	103	131.6	56	3.02	20		
210-219-25S0-5D	21.0-21.9	25	108	138.2	56	3.18	21		
220-229-25S0-5D	22.0-22.9	25	113	144.8	56	3.24	22		
230-239-32S0-5D	23.0-23.9	32	118	151.3	60	3.46	23		
240-249-32S0-5D	24.0-24.9	32	124	157.9	60	3.62	24		
250-259-32S0-5D	25.0-25.9	32	129	164.5	60	3.80	25		

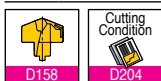

- OAL = LPR+LS
- SSC : Seat size code

TCD...T...-8D



Head changeable drill holders - Weldon type shank



- Drilling depth: 8x diameter

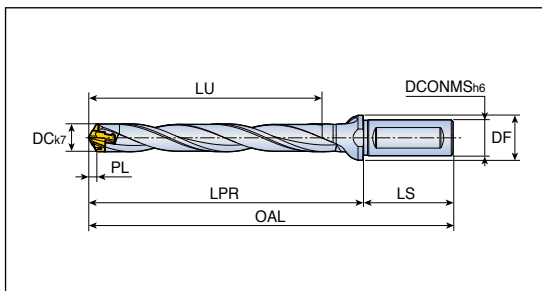

Designation	Dimension (mm)								Clamping key
	DC	DCONMS	DF	LU	LPR	LS	PL	SSC	
TCD 070-074-12T3-8D	7.0-7.4	12	16	57	70.6	45	1.01	7	K TCD D060-D099
075-079-12T3-8D	7.5-7.9	12	16	61	74.6	45	1.10	7	
080-084-12T3-8D	8.0-8.4	12	16	65	79.4	45	1.20	8	
085-089-12T3-8D	8.5-8.9	12	16	69	83.4	45	1.29	8	
090-094-12T3-8D	9.0-9.4	12	16	73	87.8	45	1.35	9	
095-099-12T3-8D	9.5-9.9	12	16	77	91.8	45	1.44	9	
100-104-16T3-8D	10.0-10.4	16	20	82	96.2	48	1.50	10	K TCD D100-D199
105-109-16T3-8D	10.5-10.9	16	20	86	100.2	48	1.59	10	
110-114-16T3-8D	11.0-11.4	16	20	90	104.6	48	1.67	11	
115-119-16T3-8D	11.5-11.9	16	20	94	108.6	48	1.76	11	
120-124-16T3-8D	12.0-12.4	16	20	98	113.0	48	1.82	12	
125-129-16T3-8D	12.5-12.9	16	20	102	117.0	48	1.91	12	
130-134-16T3-8D	13.0-13.4	16	20	106	121.6	48	1.96	13	
135-139-16T3-8D	13.5-13.9	16	20	110	125.6	48	2.05	13	
140-144-16T3-8D	14.0-14.4	16	20	114	132.2	48	2.12	14	
145-149-16T3-8D	14.5-14.9	16	20	118	136.2	48	2.21	14	
150-159-20T3-8D	15.0-15.9	20	25	122	143.7	50	2.27	15	K TCD D200-D269
160-169-20T3-8D	16.0-16.9	20	25	130	153.3	50	2.42	16	
170-179-20T3-8D	17.0-17.9	20	25	139	162.9	50	2.59	17	
180-189-25T2-8D	18.0-18.9	25	32	147	172.5	56	2.73	18	
190-199-25T2-8D	19.0-19.9	25	32	155	182.0	56	2.88	19	
200-209-25T2-8D	20.0-20.9	25	32	163	191.6	56	3.02	20	
210-219-25T2-8D	21.0-21.9	25	32	171	201.2	56	3.18	21	
220-229-25T2-8D	22.0-22.9	25	32	179	210.8	56	3.24	22	
230-239-32T2-8D	23.0-23.9	32	42	187	220.3	60	3.46	23	
240-249-32T2-8D	24.0-24.9	32	42	196	229.9	60	3.62	24	
250-259-32T2-8D	25.0-25.9	32	42	204	239.5	60	3.80	25	

D158

D96

D204

- It is recommended to make the pilot hole with a 1.5D holder
- OAL = LPR+LS
- SSC : Seat size code

TCD...S0-8D



Head changeable drill holders - Cylindrical type shank



- Drilling depth: 8x diameter

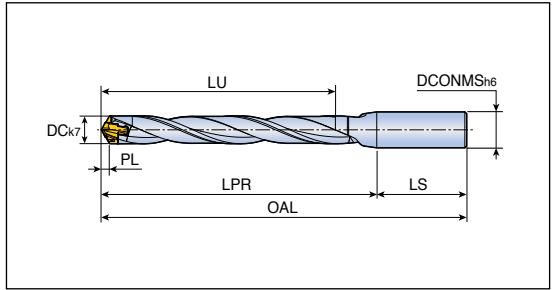

Designation	Dimension (mm)							Clamping key	
	DC	DCONMS	LU	LPR	LS	PL	SSC		
TCD 060-064-12S0-8D	6.0-6.4	12	49	62.0	45	0.96	6	K TCD D060-D099	
065-069-12S0-8D	6.5-6.9	12	53	66.3	45	1.18	6.5		
070-074-12S0-8D	7.0-7.4	12	57	70.6	45	1.01	7		
075-079-12S0-8D	7.5-7.9	12	61	74.6	45	1.10	7		
080-084-12S0-8D	8.0-8.4	12	65	79.4	45	1.20	8		
085-089-12S0-8D	8.5-8.9	12	69	83.4	45	1.29	8		
090-094-12S0-8D	9.0-9.4	12	73	87.8	45	1.35	9		
095-099-12S0-8D	9.5-9.9	12	77	91.8	45	1.44	9		
100-104-16S0-8D	10.0-10.4	16	82	96.2	48	1.50	10		K TCD D100-D199
105-109-16S0-8D	10.5-10.9	16	86	100.2	48	1.59	10		
110-114-16S0-8D	11.0-11.4	16	90	104.6	48	1.67	11		
115-119-16S0-8D	11.5-11.9	16	94	108.6	48	1.76	11		
120-124-16S0-8D	12.0-12.4	16	98	113.0	48	1.82	12		
125-129-16S0-8D	12.5-12.9	16	102	117.0	48	1.91	12		
130-134-16S0-8D	13.0-13.4	16	106	121.6	48	1.96	13		
135-139-16S0-8D	13.5-13.9	16	110	125.6	48	2.05	13		
140-144-16S0-8D	14.0-14.4	16	114	132.2	48	2.12	14		
145-149-16S0-8D	14.5-14.9	16	118	136.2	48	2.21	14		
150-159-20S0-8D	15.0-15.9	20	122	143.7	50	2.27	15	K TCD D200-D269	
160-169-20S0-8D	16.0-16.9	20	130	153.3	50	2.42	16		
170-179-20S0-8D	17.0-17.9	20	139	162.9	50	2.59	17		
180-189-25S0-8D	18.0-18.9	25	147	172.5	56	2.73	18		
190-199-25S0-8D	19.0-19.9	25	155	182.0	56	2.88	19		
200-209-25S0-8D	20.0-20.9	25	163	191.6	56	3.02	20		
210-219-25S0-8D	21.0-21.9	25	171	201.2	56	3.18	21		
220-229-25S0-8D	22.0-22.9	25	179	210.8	56	3.24	22		
230-239-32S0-8D	23.0-23.9	32	187	220.3	60	3.46	23		
240-249-32S0-8D	24.0-24.9	32	196	229.9	60	3.62	24		
250-259-32S0-8D	25.0-25.9	32	204	239.5	60	3.80	25		

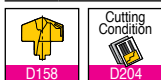

- It is recommended to make the pilot hole with a 1.5D holder
- OAL = LPR+LS
- SSC : Seat size code

Head changeable drill holders for pre-thread hole

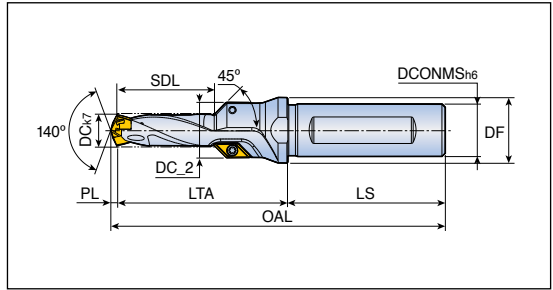

Designation	ISO thread	DC	Dimension (mm)							Drill dia. range	Insert
			SDL	LTA	LS	DC_2	DCONMS	DF	PL		
TCD 068x21x12T3-M8	M8	6.8	21	43.77	45	13.5	12	16	1.23	6.5-6.9	AOMT 06...-C45 D172
085x26x12T3-M10	M10	8.5	26	48.71	45	15.5	12	16	1.29	8.5-8.9	
102x30x16T3-M12	M12	10.2	30	52.46	48	17.0	16	20	1.54	10.0-10.4	
120x35x16T3-M14	M14	12.0	35	59.18	48	19.0	16	20	1.82	12.0-12.4	
140x39x20T3-M16	M16	14.0	39	66.88	50	21.0	20	25	2.12	14.0-14.4	
175x42x20T3-M20	M20	17.5	42	69.32	50	24.5	20	27	2.68	17.0-17.9	
210x48x25T2-M24	M24	21.0	48	76.82	56	28.0	25	32	3.18	21.0-21.9	

• OAL = LTA+LS+PL

Spare parts

Designation	Screw 	Wrench 	Clamping key 	
TCD 068	TS 22046I	TD 7	K TCD D060-D099	
TCD 085	TS 22046I	TD 7	K TCD D060-D099	
TCD 102 - 175	TS 22046I	TD 7	K TCD D100-D199	
TCD 210	TS 22046I	TD 7	K TCD D200-D269	



Plug for coolant supply in a stationary machines

TaeguTec supplies special plugs with an internal thread for coolant connections used on lathes that can be pressed into the cavity on the back end of the shank.

Description	Shank diameter	Internal thread
PL-TCD-12	12	G 1/16
PL-TCD-16	16	G 1/16
PL-TCD-20	20	G 1/8
PL-TCD-25	25	G 1/8
PL-TCD-32	32	G 1/8



Chamfering ring tools

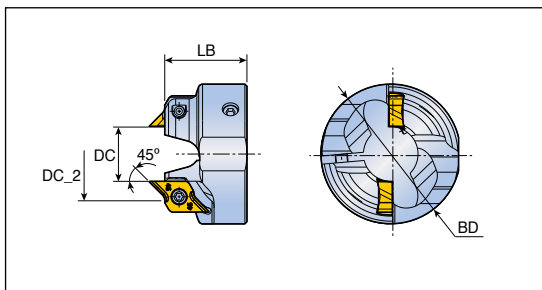

Designation	Dimension (mm)				Chamfer size	Chamfer insert
	DC	DC_2	BD	LB		
CFR D100-A45	9.8	16.56	34	20	2.5	CRNG 08...-45CD D172
D105-A45	10.3	17.06	34	20	2.5	
D110-A45	10.8	17.56	34	20	2.5	
D115-A45	11.3	18.06	34	20	2.5	
D120-A45	11.8	18.56	34	20	2.5	
D125-A45	12.3	19.06	34	20	2.5	
D130-A45	12.8	19.56	34	20	2.5	
D135-A45	13.3	20.06	34	20	2.5	
D140-A45	13.8	20.56	38	22	2.5	
D145-A45	14.3	21.06	38	22	2.5	
D150-A45	14.6	21.36	38	22	2.5	
D160-A45	15.6	22.36	42	23	2.5	
D170-A45	16.6	23.36	42	23	2.5	
D180-A45	17.6	24.36	42	23	2.5	
D190-A45	18.6	25.36	42	24	2.5	
D200-A45	19.6	26.36	42	24	2.5	
D210-A45	20.6	27.36	47	24	2.5	
D220-A45	21.6	28.36	47	24	2.5	
D230-A45	22.6	29.36	47	24	2.5	
D240-A45	23.6	30.36	47	24	2.5	
D250-A45	24.6	31.36	47	24	2.5	

Spare parts

Designation	Insert screw 	Wrench 	Clamping screw 	L-wrench
CFR D100 - D135	SO 25065I	TD 7	SH M3x0.5x10 ⁽¹⁾	L-W2.5
CFR D140 - D150	SO 25065I	TD 7	SH M4x0.7x12 ⁽²⁾	L-W3
CFR D160 - D250	SO 25065I	TD 7	SH M5x0.8x16 ⁽³⁾	L-W4

- ⁽¹⁾ Clamping torque: 2-3 [N·m] ⁽²⁾ Clamping torque: 3.5-4.5 [N·m] ⁽³⁾ Clamping torque: 5-6 [N·m]



D244

Modular drill heads

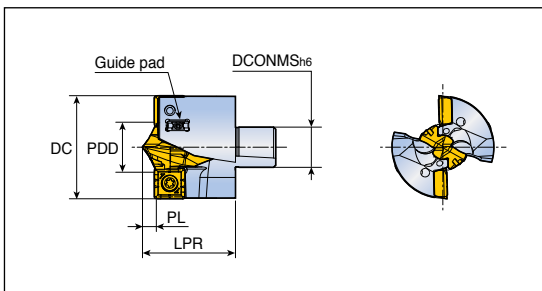

Designation	Dimension (mm)					Clamping Key	Insert	
	DC	DCONMS	LPR	PL	PDD		Center	Outer
TNDH 2600-C26-TP	26	10.4	24.9	3.98	15.9	K TCD D15-D16 CO	TCD-159-P-CO+	SPGX 06...DW
2700-C26-TP	27	10.4	25.4	4.14	16.9	K TCD D15-D16 CO	TCD-169-P-CO+	SPGX 06...DW
2800-C28-TP	28	11.2	26.9	4.29	17.9	K TCD D17-D19 CO	TCD-179-P-CO+	SPGX 06...DW
2900-C28-TP	29	11.2	26.6	3.97	15.9	K TCD D15-D16 CO	TCD-159-P-CO+	SPGX 07...DW
3000-C30-TP	30	12.0	28.3	4.14	16.9	K TCD D15-D16 CO	TCD-169-P-CO+	SPGX 07...DW
3100-C30-TP	31	12.0	28.5	4.30	17.9	K TCD D17-D19 CO	TCD-179-P-CO+	SPGX 07...DW
3200-C32-TP	32	12.8	30.3	4.46	18.9	K TCD D17-D19 CO	TCD-189-P-CO+	SPGX 07...DW
3300-C32-TP	33	12.8	29.8	3.97	15.9	K TCD D15-D16 CO	TCD-159-P-CO+	SPGX 09...DW
3400-C34-TP	34	13.6	31.6	4.14	16.9	K TCD D15-D16 CO	TCD-169-P-CO+	SPGX 09...DW
3500-C34-TP	35	13.6	31.8	4.30	17.9	K TCD D17-D19 CO	TCD-179-P-CO+	SPGX 09...DW
3600-C36-TP	36	14.4	33.5	4.46	18.9	K TCD D17-D19 CO	TCD-189-P-CO+	SPGX 09...DW
3700-C36-TP	37	14.4	33.3	4.14	16.9	K TCD D15-D16 CO	TCD-169-P-CO+	SPGX 11...DW
3800-C38-TP	38	15.2	35.0	4.30	17.9	K TCD D17-D19 CO	TCD-179-P-CO+	SPGX 11...DW
3900-C38-TP	39	15.2	35.2	4.46	18.9	K TCD D17-D19 CO	TCD-189-P-CO+	SPGX 11...DW
4000-C40-TP	40	16.0	36.9	4.62	19.9	K TCD D17-D19 CO	TCD-199-P-CO+	SPGX 11...DW
4100-C40-TP	41	16.0	37.1	4.78	20.9	K TCD D20-D21 CO	TCD-209-P-CO+	SPGX 11...DW
4200-C42-TP	42	16.8	38.9	4.95	21.9	K TCD D20-D21 CO	TCD-219-P-CO+	SPGX 11...DW
4300-C42-TP	43	16.8	38.9	5.11	22.9	K TCD D22-D23 CO	TCD-229-P-CO+	SPGX 11...DW



- DCONMS : Holder connection size
- Guide pad is sold separately from drill head

Spare parts

Designation	For double pitch screw		For SPGX		For Guide pad	
	Screw1	Wrench1	Screw2	Wrench2	Screw3	Wrench3
TNDH 2600-2800						
TNDH 2600-2800	TDPS 0512-T7	TD 7	TS 220521/HG	TD 7	TS 200431/HG-P	TD 6P
TNDH 2900-3200	TDPS 0512-T7	TD 7	TS 250641	TD 8	TS 200431/HG-P	TD 6P
TNDH 3300-3500	TDPS 0512-T7	TD 7	TS 350881	TD 10	TS 200431/HG-P	TD 6P
TNDH 3600	TDPS 0618-T8	TD 8	TS 350881	TD 10	TS 200431/HG-P	TD 6P
TNDH 3700-4300	TDPS 0618-T8	TD 8	TS 400931	TD 15	TS 200431/HG-P	TD 6P



TNDH-TP

Modular drill heads

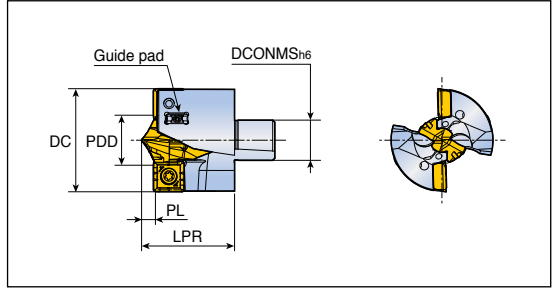

Designation	Dimension (mm)					Clamping Key	Insert	
	DC	DCONMS	LPR	PL	PDD		Center	Outer
TNDH 4400-C44-TP	44	17.6	40.8	5.28	23.9	K TCD D22-D23 CO	TCD-239-P-CO+	SPGX 11...DW
4500-C44-TP	45	17.6	41.0	5.44	24.9	K TCD D24-D25 CO	TCD-249-P-CO+	SPGX 11...DW
4600-C46-TP	46	18.4	42.2	4.95	21.9	K TCD D20-D21 CO	TCD-219-P-CO+	SPGX 14...DW
4700-C46-TP	47	18.4	42.3	5.11	22.9	K TCD D22-D23 CO	TCD-229-P-CO+	SPGX 14...DW
4800-C48-TP	48	19.2	44.0	5.28	23.9	K TCD D22-D23 CO	TCD-239-P-CO+	SPGX 14...DW
4900-C48-TP	49	19.2	44.3	5.44	24.9	K TCD D24-D25 CO	TCD-249-P-CO+	SPGX 14...DW
5000-C48-TP	50	19.2	46.0	5.61	25.9	K TCD D24-D25 CO	TCD-259-P-CO+	SPGX 14...DW
								D173

- DCONMS: Holder connection size
- Guide pad is sold separately from drill head

Spare parts

Designation	For double pitch screw		For SPGX		For Guide pad	
	Screw1	Wrench1	Screw2	Wrench2	Screw3	Wrench3
TNDH 4400-4500	TDPS 0722-W3.0	F-W3.0	TS 40093I	TD 15	TS 20043I/HG-P	TD 6P
TNDH 4600-5000	TDPS 0722-W3.0	F-W3.0	SO 50090I	TD 20	TS 20043I/HG-P	TD 6P

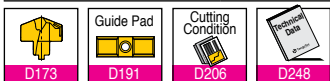

MDB...T2-3

Modular drill holders - Weldon type shank



- Drilling depth: 3x diameter

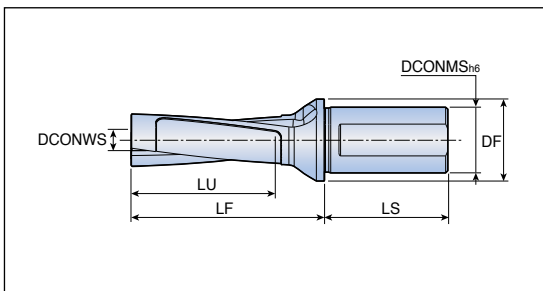

Designation	Dimension (mm)						
	DC	DCONWS	DCONMS	DF	LU	LF	LS
MDB D26/27-081-32T2-C26-3	26-27	10.4	32	40	60	94.3	60
D28/29-087-32T2-C28-3	28-29	11.2	32	40	64	100.5	60
D30/31-093-32T2-C30-3	30-31	12.0	32	40	69	105.5	60
D32/33-099-32T2-C32-3	32-33	12.8	32	40	73	111.7	60
D34/35-105-40T2-C34-3	34-35	13.6	40	50	78	120.2	68
D36/37-111-40T2-C36-3	36-37	14.4	40	50	82	126.5	68
D38/39-117-40T2-C38-3	38-39	15.2	40	50	86	131.4	68
D40/41-123-40T2-C40-3	40-41	16.0	40	50	91	137.6	68
D42/43-129-40T2-C42-3	42-43	16.8	40	50	95	143.8	68
D44/45-135-40T2-C44-3	44-45	17.6	40	50	99	150.0	68
D46/47-141-50T2-C46-3	46-47	18.4	50	60	104	154.5	80
D48/50-150-50T2-C48-3	48-50	19.2	50	60	111	160.9	80

- DC : Cutting diameter range
- DCONWS : Modular head connection size

Spare parts

Designation	Wrench	Wrench handle		
MDB D26/27-D34/35-3	BLD H-W2.5x210	SW6-T-SH		
MDB D36/37-D42/43-3	BLD H-W3.0x225	SW6-T-SH		
MDB D44/45-D48/50-3	BLD H-W4.0x255	SW6-T-SH		

- Wrench: Disassemble the modular head from the modular body (Insert from the rear shank)



Modular drill holders - Weldon type shank



- Drilling depth: 5xdiameter

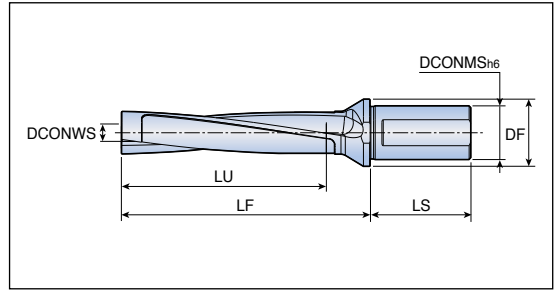

Designation	Dimension (mm)						
	DC	DCONWS	DCONMS	DF	LU	LF	LS
MDB D26/27-135-32T2-C26-5	26-27	10.4	32	40	114	148.3	60
D28/29-145-32T2-C28-5	28-29	11.2	32	40	122	158.5	60
D30/31-155-32T2-C30-5	30-31	12.0	32	40	131	167.5	60
D32/33-165-32T2-C32-5	32-33	12.8	32	40	139	177.7	60
D34/35-175-40T2-C34-5	34-35	13.6	40	50	148	190.2	68
D36/37-185-40T2-C36-5	36-37	14.4	40	50	156	200.5	68
D38/39-195-40T2-C38-5	38-39	15.2	40	50	164	209.4	68
D40/41-205-40T2-C40-5	40-41	16.0	40	50	173	219.6	68
D42/43-215-40T2-C42-5	42-43	16.8	40	50	181	229.8	68
D44/45-225-40T2-C44-5	44-45	17.6	40	50	189	240.0	68
D46/47-235-50T2-C46-5	46-47	18.4	50	60	198	248.5	80
D48/50-250-50T2-C48-5	48-50	19.2	50	60	211	258.9	80

- DC : Cutting diameter range
- DCONWS : Modular head connection size

Spare parts

Designation	Wrench	Wrench handle		
MDB D26/27-D34/35-5	BLD H-W2.5x280	SW6-T-SH		
MDB D36/37-D42/43-5	BLD H-W3.0x310	SW6-T-SH		
MDB D44/45-D48/50-5	BLD H-W4.0x350	SW6-T-SH		

- Wrench: Disassemble the modular head from the modular body (Insert from the rear shank)



Head changeable drill holders - Weldon type shank



- Drilling depth: 3x diameter

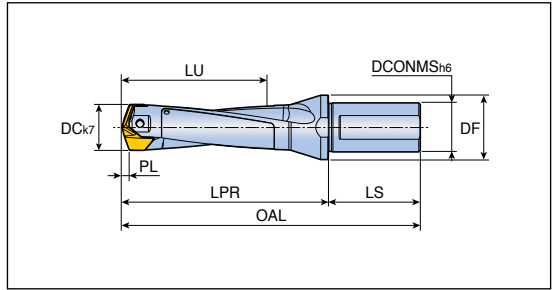

Designation	Dimension (mm)							
	DC	DCONMS	DF	LU	LPR	LS	PL	SSC
LCD 200-209-25T2-3D	20.0-20.9	25	32	63	92.1	56	3.11	20
210-219-25T2-3D	21.0-21.9	25	32	66	95.3	56	3.29	21
220-229-25T2-3D	22.0-22.9	25	32	69	98.4	56	3.42	22
230-239-25T2-3D	23.0-23.9	25	32	73	101.6	56	3.60	23
240-249-32T2-3D	24.0-24.9	32	40	76	110.7	60	3.73	24
250-259-32T2-3D	25.0-25.9	32	40	79	113.9	60	3.91	25
260-269-32T2-3D	26.0-26.9	32	40	82	117.0	60	4.04	26
270-279-32T2-3D	27.0-27.9	32	40	85	120.2	60	4.22	27
280-289-32T2-3D	28.0-28.9	32	40	88	128.4	60	4.35	28
290-299-32T2-3D	29.0-29.9	32	40	92	131.5	60	4.53	29
300-309-32T2-3D	30.0-30.9	32	42	95	134.7	60	4.67	30
310-319-32T2-3D	31.0-31.9	32	42	98	137.9	60	4.85	31
320-329-40T2-3D	32.0-32.9	40	48	101	143.0	68	4.98	32
330-339-40T2-3D	33.0-33.9	40	48	104	146.2	68	5.16	33
340-349-40T2-3D	34.0-34.9	40	48	107	149.3	68	5.34	34
350-359-40T2-3D	35.0-35.9	40	48	110	152.4	68	5.44	35
360-369-40T2-3D	36.0-36.9	40	48	114	155.6	68	5.62	36
370-379-40T2-3D	37.0-37.9	40	48	117	158.8	68	5.80	37
380-389-40T2-3D	38.0-38.9	40	50	120	166.9	68	5.91	38
390-399-40T2-3D	39.0-39.9	40	50	123	170.1	68	6.09	39
400-410-40T2-3D	40.0-41.0	40	50	126	173.3	68	6.27	40

- OAL = LPR+LS
- SSC: Seat size code

Spare parts

Designation	Screw	Wrench	Wrench handle	
LCD 200-219-3D	TS 40178D25	BLD T20/S7	SW6-T-SH	
LCD 220-239-3D	TS 40198D28	BLD T20/S7	SW6-T-SH	
LCD 240-259-3D	TS 40210D3	BLD T20/S7	SW6-T-SH	
LCD 260-279-3D	TS 50230D3	BLD T20/S7	SW6-T-SH	
LCD 280-299-3D	TS 50250D35	BLD T25/S7	SW6-T-SH	
LCD 300-319-3D	TS 60265D4	BLD T25/S7	SW6-T-SH	
LCD 320-349-3D	TS 60285D42	BLD T25/S7	SW6-T-SH	
LCD 350-379-3D	TS 60320D5	BLD T25/S7	SW6-T-SH	
LCD 380-410-3D	TS 80340D6	BLD T25/S7	SW6-T-SH	

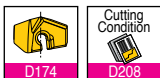

Head changeable drill holders - Weldon type shank



- Drilling depth: 5x diameter

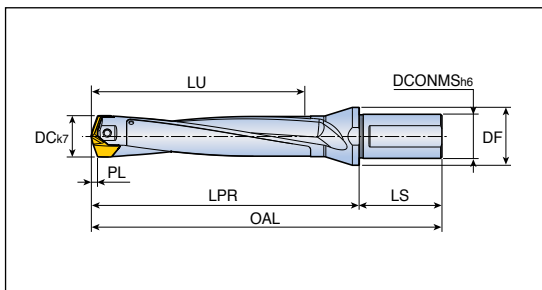

Designation	Dimension (mm)							
	DC	DCONMS	DF	LU	LPR	LS	PL	SSC
LCD 200-209-25T2-5D	20.0-20.9	25	32	103	132.1	56	3.11	20
210-219-25T2-5D	21.0-21.9	25	32	108	137.3	56	3.29	21
220-229-25T2-5D	22.0-22.9	25	32	113	142.4	56	3.42	22
230-239-25T2-5D	23.0-23.9	25	32	119	147.6	56	3.60	23
240-249-32T2-5D	24.0-24.9	32	40	124	158.7	60	3.73	24
250-259-32T2-5D	25.0-25.9	32	40	129	163.9	60	3.91	25
260-269-32T2-5D	26.0-26.9	32	40	134	169.0	60	4.04	26
270-279-32T2-5D	27.0-27.9	32	40	139	174.2	60	4.22	27
280-289-32T2-5D	28.0-28.9	32	40	144	184.4	60	4.35	28
290-299-32T2-5D	29.0-29.9	32	40	150	189.5	60	4.53	29
300-309-32T2-5D	30.0-30.9	32	42	155	194.7	60	4.67	30
310-319-32T2-5D	31.0-31.9	32	42	160	199.9	60	4.85	31
320-329-40T2-5D	32.0-32.9	40	48	165	207.0	68	4.98	32
330-339-40T2-5D	33.0-33.9	40	48	170	212.2	68	5.16	33
340-349-40T2-5D	34.0-34.9	40	48	175	217.3	68	5.34	34
350-359-40T2-5D	35.0-35.9	40	48	180	222.4	68	5.44	35
360-369-40T2-5D	36.0-36.9	40	48	186	227.6	68	5.62	36
370-379-40T2-5D	37.0-37.9	40	48	191	232.8	68	5.80	37
380-389-40T2-5D	38.0-38.9	40	50	196	242.9	68	5.91	38
390-399-40T2-5D	39.0-39.9	40	50	201	248.1	68	6.09	39
400-410-40T2-5D	40.0-41.0	40	50	206	253.3	68	6.27	40

- OAL = LPR+LS
- SSC: Seat size code

Spare parts

Designation	Screw	Wrench	Wrench handle	
LCD 200-219-5D	TS 40178D25	BLD T20/S7	SW6-T-SH	
LCD 220-239-5D	TS 40198D28	BLD T20/S7	SW6-T-SH	
LCD 240-259-5D	TS 40210D3	BLD T20/S7	SW6-T-SH	
LCD 260-279-5D	TS 50230D3	BLD T20/S7	SW6-T-SH	
LCD 280-299-5D	TS 50250D35	BLD T25/S7	SW6-T-SH	
LCD 300-319-5D	TS 60265D4	BLD T25/S7	SW6-T-SH	
LCD 320-349-5D	TS 60285D42	BLD T25/S7	SW6-T-SH	
LCD 350-379-5D	TS 60320D5	BLD T25/S7	SW6-T-SH	
LCD 380-410-5D	TS 80340D6	BLD T25/S7	SW6-T-SH	

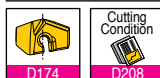

Head changeable drill holders - Weldon type shank



- Drilling depth: 8x diameter

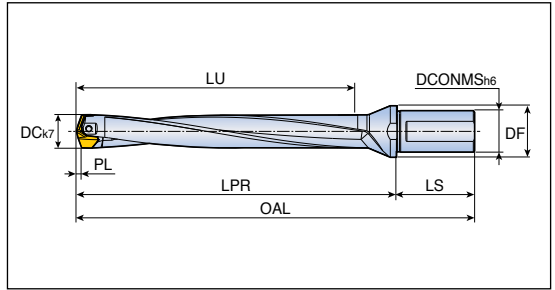

Designation	Dimension (mm)							
	DC	DCONMS	DF	LU	LPR	LS	PL	SSC
LCD 200-209-25T2-8D	20.0-20.9	25	32	163.1	192.1	56	3.11	20
210-219-25T2-8D	21.0-21.9	25	32	171.3	200.1	56	3.29	21
220-229-25T2-8D	22.0-22.9	25	32	179.4	208.4	56	3.42	22
230-239-25T2-8D	23.0-23.9	25	32	187.6	216.4	56	3.60	23
240-249-32T2-8D	24.0-24.9	32	40	195.7	230.7	60	3.73	24
250-259-32T2-8D	25.0-25.9	32	40	203.9	238.7	60	3.91	25
260-269-32T2-8D	26.0-26.9	32	40	212.0	247.0	60	4.04	26
270-279-32T2-8D	27.0-27.9	32	40	220.2	255.0	60	4.22	27
280-289-32T2-8D	28.0-28.9	32	40	228.4	268.4	60	4.35	28
290-299-32T2-8D	29.0-29.9	32	40	236.5	276.4	60	4.53	29
300-309-32T2-8D	30.0-30.9	32	42	244.7	284.7	60	4.67	30
310-319-32T2-8D	31.0-31.9	32	42	252.9	292.7	60	4.85	31
320-329-40T2-8D	32.0-32.9	40	48	261.0	303.0	68	4.98	32
330-339-40T2-8D	33.0-33.9	40	48	269.2	311.0	68	5.16	33
340-349-40T2-8D	34.0-34.9	40	48	277.3	319.0	68	5.34	34
350-359-40T2-8D	35.0-35.9	40	48	285.4	327.4	68	5.44	35
360-369-40T2-8D	36.0-36.9	40	48	293.6	335.4	68	5.62	36
370-379-40T2-8D	37.0-37.9	40	48	301.8	343.4	68	5.80	37
380-389-40T2-8D	38.0-38.9	40	50	309.9	356.9	68	5.91	38
390-399-40T2-8D	39.0-39.9	40	50	318.1	364.9	68	6.09	39
400-410-40T2-8D	40.0-41.0	40	50	326.3	372.9	68	6.27	40

- OAL = LPR + LS
- SSC: Seat size code
- It is recommended to make the pilot hole with a 3D holder

Spare parts

Designation	Screw	Wrench	Wrench handle	
LCD 200-219-8D	TS 40178D25	BLD T20/S7	SW6-T-SH	
LCD 220-239-8D	TS 40198D28	BLD T20/S7	SW6-T-SH	
LCD 240-259-8D	TS 40210D3	BLD T20/S7	SW6-T-SH	
LCD 260-279-8D	TS 50230D3	BLD T20/S7	SW6-T-SH	
LCD 280-299-8D	TS 50250D35	BLD T25/S7	SW6-T-SH	
LCD 300-319-8D	TS 60265D4	BLD T25/S7	SW6-T-SH	
LCD 320-349-8D	TS 60285D42	BLD T25/S7	SW6-T-SH	
LCD 350-379-8D	TS 60320D5	BLD T25/S7	SW6-T-SH	
LCD 380-410-8D	TS 80340D6	BLD T25/S7	SW6-T-SH	

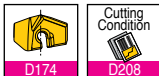

Solid carbide drills without oil holes



- Drilling depth: 3xdiameter

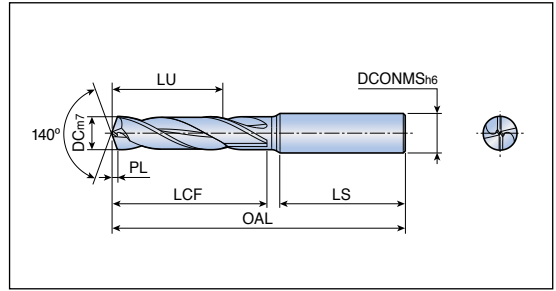

Designation	Dimension (mm)							Grade
	DC	DCONMS	OAL	LU	LCF	LS	PL	TT9030
NHD 030-014-06 PE3	3.0	6.0	62	14	21	34	0.5	●
031-014-06 PE3	3.1	6.0	62	14	21	34	0.5	●
032-014-06 PE3	3.2	6.0	62	14	21	34	0.5	●
033-014-06 PE3	3.3	6.0	62	14	21	34	0.5	●
034-014-06 PE3	3.4	6.0	62	14	21	34	0.5	●
035-014-06 PE3	3.5	6.0	62	14	21	34	0.6	●
036-014-06 PE3	3.6	6.0	62	14	21	34	0.6	●
037-014-06 PE3	3.7	6.0	62	14	21	34	0.6	●
038-017-06 PE3	3.8	6.0	66	17	25	35	0.6	●
039-017-06 PE3	3.9	6.0	66	17	25	35	0.6	●
040-017-06 PE3	4.0	6.0	66	17	25	35	0.6	●
041-017-06 PE3	4.1	6.0	66	17	25	35	0.7	●
042-017-06 PE3	4.2	6.0	66	17	25	35	0.7	●
043-017-06 PE3	4.3	6.0	66	17	25	35	0.7	●
044-017-06 PE3	4.4	6.0	66	17	25	35	0.7	●
045-017-06 PE3	4.5	6.0	66	17	25	35	0.7	●
046-017-06 PE3	4.6	6.0	66	17	25	35	0.7	●
047-017-06 PE3	4.7	6.0	66	17	25	35	0.8	●
048-020-06 PE3	4.8	6.0	66	20	29	36	0.8	●
049-020-06 PE3	4.9	6.0	66	20	29	36	0.8	●
050-020-06 PE3	5.0	6.0	66	20	29	36	0.8	●
051-020-06 PE3	5.1	6.0	66	20	29	36	0.8	●
052-020-06 PE3	5.2	6.0	66	20	29	36	0.8	●
053-020-06 PE3	5.3	6.0	66	20	29	36	0.8	●
054-020-06 PE3	5.4	6.0	66	20	29	36	0.8	●
055-020-06 PE3	5.5	6.0	66	20	29	36	0.9	●
056-020-06 PE3	5.6	6.0	66	20	29	36	0.9	●
057-020-06 PE3	5.7	6.0	66	20	29	36	0.9	●
058-020-06 PE3	5.8	6.0	66	20	29	36	0.9	●
059-020-06 PE3	5.9	6.0	66	20	29	36	0.9	●
060-020-06 PE3	6.0	6.0	66	20	29	36	0.9	●
061-024-08 PE3	6.1	8.0	79	24	35	36	1.0	●
062-024-08 PE3	6.2	8.0	79	24	35	36	1.0	●
063-024-08 PE3	6.3	8.0	79	24	35	36	1.0	●
064-024-08 PE3	6.4	8.0	79	24	35	36	1.0	●

●: Standard items



Solid carbide drills without oil holes



• Drilling depth: 3x diameter

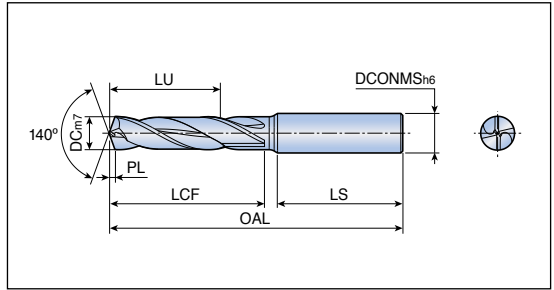

Designation	Dimension (mm)							Grade
	DC	DCONMS	OAL	LU	LCF	LS	PL	TT9030
NHD 065-024-08 PE3	6.5	8.0	79	24	35	36	1.0	●
066-024-08 PE3	6.6	8.0	79	24	35	36	1.0	●
067-024-08 PE3	6.7	8.0	79	24	35	36	1.1	●
068-024-08 PE3	6.8	8.0	79	24	35	36	1.1	●
069-024-08 PE3	6.9	8.0	79	24	35	36	1.1	●
070-024-08 PE3	7.0	8.0	79	24	35	36	1.1	●
071-029-08 PE3	7.1	8.0	79	29	42	36	1.1	●
072-029-08 PE3	7.2	8.0	79	29	42	36	1.1	●
073-029-08 PE3	7.3	8.0	79	29	42	36	1.1	●
074-029-08 PE3	7.4	8.0	79	29	42	36	1.2	●
075-029-08 PE3	7.5	8.0	79	29	42	36	1.2	●
076-029-08 PE3	7.6	8.0	79	29	42	36	1.2	●
077-029-08 PE3	7.7	8.0	79	29	42	36	1.2	●
078-029-08 PE3	7.8	8.0	79	29	42	36	1.2	●
079-029-08 PE3	7.9	8.0	79	29	42	36	1.3	●
080-029-08 PE3	8.0	8.0	79	29	42	36	1.3	●
081-035-10 PE3	8.1	10.0	89	35	48	40	1.3	●
082-035-10 PE3	8.2	10.0	89	35	48	40	1.3	●
083-035-10 PE3	8.3	10.0	89	35	48	40	1.3	●
084-035-10 PE3	8.4	10.0	89	35	48	40	1.3	●
085-035-10 PE3	8.5	10.0	89	35	48	40	1.3	●
086-035-10 PE3	8.6	10.0	89	35	48	40	1.4	●
087-035-10 PE3	8.7	10.0	89	35	48	40	1.4	●
088-035-10 PE3	8.8	10.0	89	35	48	40	1.4	●
089-035-10 PE3	8.9	10.0	89	35	48	40	1.4	●
090-035-10 PE3	9.0	10.0	89	35	48	40	1.4	●
091-035-10 PE3	9.1	10.0	89	35	48	40	1.4	●
092-035-10 PE3	9.2	10.0	89	35	48	40	1.4	●
093-035-10 PE3	9.3	10.0	89	35	48	40	1.5	●
094-035-10 PE3	9.4	10.0	89	35	48	40	1.5	●
095-035-10 PE3	9.5	10.0	89	35	48	40	1.5	●
096-035-10 PE3	9.6	10.0	89	35	48	40	1.5	●
097-035-10 PE3	9.7	10.0	89	35	48	40	1.5	●
098-035-10 PE3	9.8	10.0	89	35	48	40	1.6	●
099-035-10 PE3	9.9	10.0	89	35	48	40	1.6	●

●: Standard items



Solid carbide drills without oil holes



• Drilling depth: 4-5x diameter

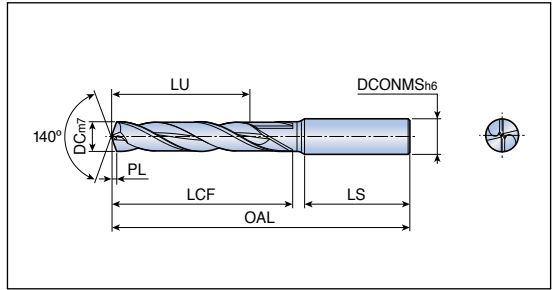

Designation	Dimension (mm)							Grade
	DC	DCONMS	OAL	LU	LCF	LS	PL	TT9030
NHD 030-023-06 PE5	3.0	6.0	66	23	29	34	0.5	●
031-023-06 PE5	3.1	6.0	66	23	29	34	0.5	●
032-023-06 PE5	3.2	6.0	66	23	29	34	0.5	●
033-023-06 PE5	3.3	6.0	66	23	29	34	0.5	●
034-023-06 PE5	3.4	6.0	66	23	29	34	0.5	●
035-023-06 PE5	3.5	6.0	66	23	29	34	0.6	●
036-023-06 PE5	3.6	6.0	66	23	29	34	0.6	●
037-023-06 PE5	3.7	6.0	66	23	29	34	0.6	●
038-029-06 PE5	3.8	6.0	74	29	37	35	0.6	●
039-029-06 PE5	3.9	6.0	74	29	37	35	0.6	●
040-029-06 PE5	4.0	6.0	74	29	37	35	0.6	●
041-029-06 PE5	4.1	6.0	74	29	37	35	0.7	●
042-029-06 PE5	4.2	6.0	74	29	37	35	0.7	●
043-029-06 PE5	4.3	6.0	74	29	37	35	0.7	●
044-029-06 PE5	4.4	6.0	74	29	37	35	0.7	●
045-029-06 PE5	4.5	6.0	74	29	37	35	0.7	●
046-029-06 PE5	4.6	6.0	74	29	37	35	0.7	●
047-029-06 PE5	4.7	6.0	74	29	37	35	0.8	●
048-035-06 PE5	4.8	6.0	82	35	45	36	0.8	●
049-035-06 PE5	4.9	6.0	82	35	45	36	0.8	●
050-035-06 PE5	5.0	6.0	82	35	45	36	0.8	●
051-035-06 PE5	5.1	6.0	82	35	45	36	0.8	●
052-035-06 PE5	5.2	6.0	82	35	45	36	0.8	●
053-035-06 PE5	5.3	6.0	82	35	45	36	0.8	●
054-035-06 PE5	5.4	6.0	82	35	45	36	0.8	●
055-035-06 PE5	5.5	6.0	82	35	45	36	0.9	●
056-035-06 PE5	5.6	6.0	82	35	45	36	0.9	●
057-035-06 PE5	5.7	6.0	82	35	45	36	0.9	●
058-035-06 PE5	5.8	6.0	82	35	45	36	0.9	●
059-035-06 PE5	5.9	6.0	82	35	45	36	0.9	●
060-035-06 PE5	6.0	6.0	82	35	45	36	0.9	●
061-043-08 PE5	6.1	8.0	91	43	54	36	1.0	●
062-043-08 PE5	6.2	8.0	91	43	54	36	1.0	●
063-043-08 PE5	6.3	8.0	91	43	54	36	1.0	●
064-043-08 PE5	6.4	8.0	91	43	54	36	1.0	●

●: Standard items



Solid carbide drills without oil holes

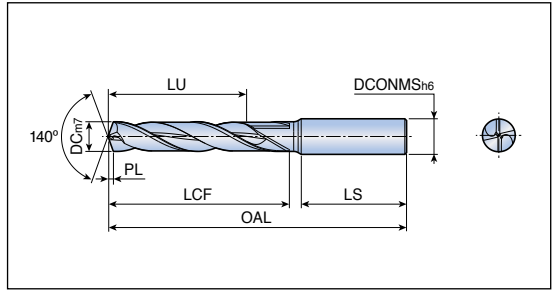

• Drilling depth: 4-5xdiameter



Designation	Dimension (mm)							Grade TT9030
	DC	DCONMS	OAL	LU	LCF	LS	PL	
NHD 065-043-08 PE5	6.5	8.0	91	43	54	36	1.0	●
066-043-08 PE5	6.6	8.0	91	43	54	36	1.0	●
067-043-08 PE5	6.7	8.0	91	43	54	36	1.1	●
068-043-08 PE5	6.8	8.0	91	43	54	36	1.1	●
069-043-08 PE5	6.9	8.0	91	43	54	36	1.1	●
070-043-08 PE5	7.0	8.0	91	43	54	36	1.1	●
071-043-08 PE5	7.1	8.0	91	43	54	36	1.1	●
072-043-08 PE5	7.2	8.0	91	43	54	36	1.1	●
073-043-08 PE5	7.3	8.0	91	43	54	36	1.1	●
074-043-08 PE5	7.4	8.0	91	43	54	36	1.2	●
075-043-08 PE5	7.5	8.0	91	43	54	36	1.2	●
076-043-08 PE5	7.6	8.0	91	43	54	36	1.2	●
077-043-08 PE5	7.7	8.0	91	43	54	36	1.2	●
078-043-08 PE5	7.8	8.0	91	43	54	36	1.2	●
079-043-08 PE5	7.9	8.0	91	43	54	36	1.3	●
080-043-08 PE5	8.0	8.0	91	43	54	36	1.3	●
081-049-10 PE5	8.1	10.0	103	49	62	40	1.3	●
082-049-10 PE5	8.2	10.0	103	49	62	40	1.3	●
083-049-10 PE5	8.3	10.0	103	49	62	40	1.3	●
084-049-10 PE5	8.4	10.0	103	49	62	40	1.3	●
085-049-10 PE5	8.5	10.0	103	49	62	40	1.3	●
086-049-10 PE5	8.6	10.0	103	49	62	40	1.4	●
087-049-10 PE5	8.7	10.0	103	49	62	40	1.4	●
088-049-10 PE5	8.8	10.0	103	49	62	40	1.4	●
089-049-10 PE5	8.9	10.0	103	49	62	40	1.4	●
090-049-10 PE5	9.0	10.0	103	49	62	40	1.4	●
091-049-10 PE5	9.1	10.0	103	49	62	40	1.4	●
092-049-10 PE5	9.2	10.0	103	49	62	40	1.4	●
093-049-10 PE5	9.3	10.0	103	49	62	40	1.5	●
094-049-10 PE5	9.4	10.0	103	49	62	40	1.5	●
095-049-10 PE5	9.5	10.0	103	49	62	40	1.5	●
096-049-10 PE5	9.6	10.0	103	49	62	40	1.5	●
097-049-10 PE5	9.7	10.0	103	49	62	40	1.5	●
098-049-10 PE5	9.8	10.0	103	49	62	40	1.6	●
099-049-10 PE5	9.9	10.0	103	49	62	40	1.6	●

●: Standard items



Solid carbide drills with oil holes

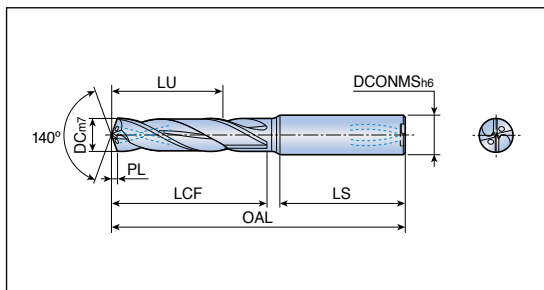

- Drilling depth: 3xdiameter



Designation	Dimension (mm)							Grade
	DC	DCONMS	OAL	LU	LCF	LS	PL	TT9030
NHD 030-014-06 PI3	3.0	6.0	62	14	21	34	0.5	●
031-014-06 PI3	3.1	6.0	62	14	21	34	0.5	●
032-014-06 PI3	3.2	6.0	62	14	21	34	0.5	●
033-014-06 PI3	3.3	6.0	62	14	21	34	0.5	●
034-014-06 PI3	3.4	6.0	62	14	21	34	0.5	●
035-014-06 PI3	3.5	6.0	62	14	21	34	0.6	●
036-014-06 PI3	3.6	6.0	62	14	21	34	0.6	●
037-014-06 PI3	3.7	6.0	62	14	21	34	0.6	●
038-017-06 PI3	3.8	6.0	66	17	25	35	0.6	●
039-017-06 PI3	3.9	6.0	66	17	25	35	0.6	●
040-017-06 PI3	4.0	6.0	66	17	25	35	0.6	●
041-017-06 PI3	4.1	6.0	66	17	25	35	0.7	●
042-017-06 PI3	4.2	6.0	66	17	25	35	0.7	●
043-017-06 PI3	4.3	6.0	66	17	25	35	0.7	●
044-017-06 PI3	4.4	6.0	66	17	25	35	0.7	●
045-017-06 PI3	4.5	6.0	66	17	25	35	0.7	●
046-017-06 PI3	4.6	6.0	66	17	25	35	0.7	●
047-017-06 PI3	4.7	6.0	66	17	25	35	0.8	●
048-020-06 PI3	4.8	6.0	66	20	29	36	0.8	●
049-020-06 PI3	4.9	6.0	66	20	29	36	0.8	●
050-020-06 PI3	5.0	6.0	66	20	29	36	0.8	●
051-020-06 PI3	5.1	6.0	66	20	29	36	0.8	●
052-020-06 PI3	5.2	6.0	66	20	29	36	0.8	●
053-020-06 PI3	5.3	6.0	66	20	29	36	0.8	●
054-020-06 PI3	5.4	6.0	66	20	29	36	0.8	●
055-020-06 PI3	5.5	6.0	66	20	29	36	0.9	●
056-020-06 PI3	5.6	6.0	66	20	29	36	0.9	●
057-020-06 PI3	5.7	6.0	66	20	29	36	0.9	●
058-020-06 PI3	5.8	6.0	66	20	29	36	0.9	●
059-020-06 PI3	5.9	6.0	66	20	29	36	0.9	●
060-020-06 PI3	6.0	6.0	66	20	29	36	0.9	●
061-024-08 PI3	6.1	8.0	79	24	35	36	1.0	●
062-024-08 PI3	6.2	8.0	79	24	35	36	1.0	●
063-024-08 PI3	6.3	8.0	79	24	35	36	1.0	●
064-024-08 PI3	6.4	8.0	79	24	35	36	1.0	●

●: Standard items



Solid carbide drills with oil holes



• Drilling depth: 3xdiameter

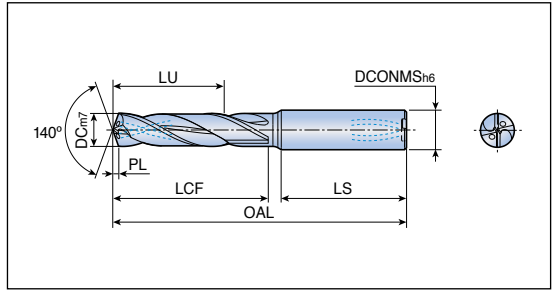

Designation	Dimension (mm)							Grade
	DC	DCONMS	OAL	LU	LCF	LS	PL	TT9030
NHD 065-024-08 PI3	6.5	8.0	79	24	35	36	1.0	●
066-024-08 PI3	6.6	8.0	79	24	35	36	1.0	●
067-024-08 PI3	6.7	8.0	79	24	35	36	1.1	●
068-024-08 PI3	6.8	8.0	79	24	35	36	1.1	●
069-024-08 PI3	6.9	8.0	79	24	35	36	1.1	●
070-024-08 PI3	7.0	8.0	79	24	35	36	1.1	●
071-029-08 PI3	7.1	8.0	79	29	42	36	1.1	●
072-029-08 PI3	7.2	8.0	79	29	42	36	1.1	●
073-029-08 PI3	7.3	8.0	79	29	42	36	1.1	●
074-029-08 PI3	7.4	8.0	79	29	42	36	1.2	●
075-029-08 PI3	7.5	8.0	79	29	42	36	1.2	●
076-029-08 PI3	7.6	8.0	79	29	42	36	1.2	●
077-029-08 PI3	7.7	8.0	79	29	42	36	1.2	●
078-029-08 PI3	7.8	8.0	79	29	42	36	1.2	●
079-029-08 PI3	7.9	8.0	79	29	42	36	1.3	●
080-029-08 PI3	8.0	8.0	79	29	42	36	1.3	●
081-035-10 PI3	8.1	10.0	89	35	48	40	1.3	●
082-035-10 PI3	8.2	10.0	89	35	48	40	1.3	●
083-035-10 PI3	8.3	10.0	89	35	48	40	1.3	●
084-035-10 PI3	8.4	10.0	89	35	48	40	1.3	●
085-035-10 PI3	8.5	10.0	89	35	48	40	1.3	●
086-035-10 PI3	8.6	10.0	89	35	48	40	1.4	●
087-035-10 PI3	8.7	10.0	89	35	48	40	1.4	●
088-035-10 PI3	8.8	10.0	89	35	48	40	1.4	●
089-035-10 PI3	8.9	10.0	89	35	48	40	1.4	●
090-035-10 PI3	9.0	10.0	89	35	48	40	1.4	●
091-035-10 PI3	9.1	10.0	89	35	48	40	1.4	●
092-035-10 PI3	9.2	10.0	89	35	48	40	1.4	●
093-035-10 PI3	9.3	10.0	89	35	48	40	1.5	●
094-035-10 PI3	9.4	10.0	89	35	48	40	1.5	●
095-035-10 PI3	9.5	10.0	89	35	48	40	1.5	●
096-035-10 PI3	9.6	10.0	89	35	48	40	1.5	●
097-035-10 PI3	9.7	10.0	89	35	48	40	1.5	●
098-035-10 PI3	9.8	10.0	89	35	48	40	1.6	●
099-035-10 PI3	9.9	10.0	89	35	48	40	1.6	●

●: Standard items



Solid carbide drills with oil holes



• Drilling depth: 4-5x diameter

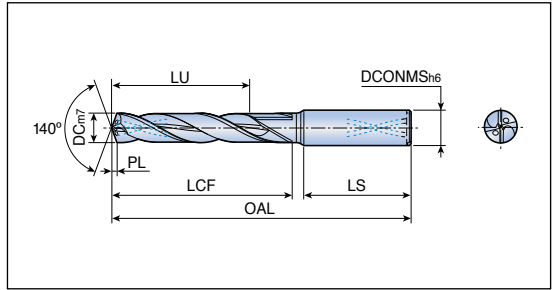

Designation	Dimension (mm)							Grade
	DC	DCONMS	OAL	LU	LCF	LS	PL	TT9030
NHD 030-023-06 PI5	3.0	6.0	66	23	29	34	0.5	●
031-023-06 PI5	3.1	6.0	66	23	29	34	0.5	●
032-023-06 PI5	3.2	6.0	66	23	29	34	0.5	●
033-023-06 PI5	3.3	6.0	66	23	29	34	0.5	●
034-023-06 PI5	3.4	6.0	66	23	29	34	0.5	●
035-023-06 PI5	3.5	6.0	66	23	29	34	0.6	●
036-023-06 PI5	3.6	6.0	66	23	29	34	0.6	●
037-023-06 PI5	3.7	6.0	66	23	29	34	0.6	●
038-029-06 PI5	3.8	6.0	74	29	37	35	0.6	●
039-029-06 PI5	3.9	6.0	74	29	37	35	0.6	●
040-029-06 PI5	4.0	6.0	74	29	37	35	0.6	●
041-029-06 PI5	4.1	6.0	74	29	37	35	0.7	●
042-029-06 PI5	4.2	6.0	74	29	37	35	0.7	●
043-029-06 PI5	4.3	6.0	74	29	37	35	0.7	●
044-029-06 PI5	4.4	6.0	74	29	37	35	0.7	●
045-029-06 PI5	4.5	6.0	74	29	37	35	0.7	●
046-029-06 PI5	4.6	6.0	74	29	37	35	0.7	●
047-029-06 PI5	4.7	6.0	74	29	37	35	0.8	●
048-035-06 PI5	4.8	6.0	82	35	45	36	0.8	●
049-035-06 PI5	4.9	6.0	82	35	45	36	0.8	●
050-035-06 PI5	5.0	6.0	82	35	45	36	0.8	●
051-035-06 PI5	5.1	6.0	82	35	45	36	0.8	●
052-035-06 PI5	5.2	6.0	82	35	45	36	0.8	●
053-035-06 PI5	5.3	6.0	82	35	45	36	0.8	●
054-035-06 PI5	5.4	6.0	82	35	45	36	0.8	●
055-035-06 PI5	5.5	6.0	82	35	45	36	0.9	●
056-035-06 PI5	5.6	6.0	82	35	45	36	0.9	●
057-035-06 PI5	5.7	6.0	82	35	45	36	0.9	●
058-035-06 PI5	5.8	6.0	82	35	45	36	0.9	●
059-035-06 PI5	5.9	6.0	82	35	45	36	0.9	●
060-035-06 PI5	6.0	6.0	82	35	45	36	0.9	●
061-043-08 PI5	6.1	8.0	91	43	54	36	1.0	●
062-043-08 PI5	6.2	8.0	91	43	54	36	1.0	●
063-043-08 PI5	6.3	8.0	91	43	54	36	1.0	●
064-043-08 PI5	6.4	8.0	91	43	54	36	1.0	●

●: Standard items



Solid carbide drills with oil holes



- Drilling depth: 4-5xdiameter

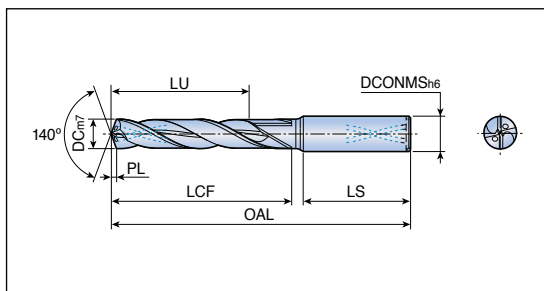

Designation	Dimension (mm)							Grade TT9030
	DC	DCONMS	OAL	LU	LCF	LS	PL	
NHD 065-043-08 PI5	6.5	8.0	91	43	54	36	1.0	●
066-043-08 PI5	6.6	8.0	91	43	54	36	1.0	●
067-043-08 PI5	6.7	8.0	91	43	54	36	1.1	●
068-043-08 PI5	6.8	8.0	91	43	54	36	1.1	●
069-043-08 PI5	6.9	8.0	91	43	54	36	1.1	●
070-043-08 PI5	7.0	8.0	91	43	54	36	1.1	●
071-043-08 PI5	7.1	8.0	91	43	54	36	1.1	●
072-043-08 PI5	7.2	8.0	91	43	54	36	1.1	●
073-043-08 PI5	7.3	8.0	91	43	54	36	1.1	●
074-043-08 PI5	7.4	8.0	91	43	54	36	1.2	●
075-043-08 PI5	7.5	8.0	91	43	54	36	1.2	●
076-043-08 PI5	7.6	8.0	91	43	54	36	1.2	●
077-043-08 PI5	7.7	8.0	91	43	54	36	1.2	●
078-043-08 PI5	7.8	8.0	91	43	54	36	1.2	●
079-043-08 PI5	7.9	8.0	91	43	54	36	1.3	●
080-043-08 PI5	8.0	8.0	91	43	54	36	1.3	●
081-049-10 PI5	8.1	10.0	103	49	62	40	1.3	●
082-049-10 PI5	8.2	10.0	103	49	62	40	1.3	●
083-049-10 PI5	8.3	10.0	103	49	62	40	1.3	●
084-049-10 PI5	8.4	10.0	103	49	62	40	1.3	●
085-049-10 PI5	8.5	10.0	103	49	62	40	1.3	●
086-049-10 PI5	8.6	10.0	103	49	62	40	1.4	●
087-049-10 PI5	8.7	10.0	103	49	62	40	1.4	●
088-049-10 PI5	8.8	10.0	103	49	62	40	1.4	●
089-049-10 PI5	8.9	10.0	103	49	62	40	1.4	●
090-049-10 PI5	9.0	10.0	103	49	62	40	1.4	●
091-049-10 PI5	9.1	10.0	103	49	62	40	1.4	●
092-049-10 PI5	9.2	10.0	103	49	62	40	1.4	●
093-049-10 PI5	9.3	10.0	103	49	62	40	1.5	●
094-049-10 PI5	9.4	10.0	103	49	62	40	1.5	●
095-049-10 PI5	9.5	10.0	103	49	62	40	1.5	●
096-049-10 PI5	9.6	10.0	103	49	62	40	1.5	●
097-049-10 PI5	9.7	10.0	103	49	62	40	1.5	●
098-049-10 PI5	9.8	10.0	103	49	62	40	1.6	●
099-049-10 PI5	9.9	10.0	103	49	62	40	1.6	●



●: Standard items

Solid carbide drills with oil holes for cast iron machining

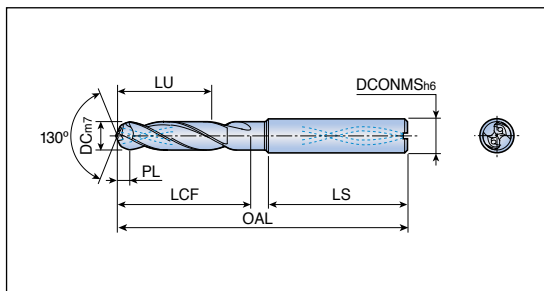

- Drilling depth: 3xdiameter



Designation	Dimension (mm)							Grade
	DC	DCONMS	OAL	LU	LCF	LS	PL	TT9030
NHD 030-014-06 KI3	3.0	6.0	62	14	20	34	1.4	●
033-014-06 KI3	3.3	6.0	62	14	20	34	1.6	●
035-014-06 KI3	3.5	6.0	62	14	20	34	1.7	●
040-017-06 KI3	4.0	6.0	66	17	24	35	1.9	●
041-017-06 KI3	4.1	6.0	66	17	24	35	2.0	●
042-017-06 KI3	4.2	6.0	66	17	24	35	2.0	●
045-017-06 KI3	4.5	6.0	66	17	24	35	2.2	●
046-017-06 KI3	4.6	6.0	66	17	24	35	2.2	●
050-020-06 KI3	5.0	6.0	66	20	27	36	2.4	●
051-020-06 KI3	5.1	6.0	66	20	27	36	2.5	●
052-020-06 KI3	5.2	6.0	66	20	27	36	2.5	●
055-020-06 KI3	5.5	6.0	66	20	27	36	2.6	●
060-020-06 KI3	6.0	6.0	66	20	27	36	2.9	●
061-024-08 KI3	6.1	8.0	79	24	34	36	2.9	●
065-024-08 KI3	6.5	8.0	79	24	34	36	3.1	●
067-024-08 KI3	6.7	8.0	79	24	34	36	3.2	●
068-024-08 KI3	6.8	8.0	79	24	34	36	3.3	●
070-024-08 KI3	7.0	8.0	79	24	34	36	3.4	●
075-029-08 KI3	7.5	8.0	79	29	40	36	3.6	●
080-029-08 KI3	8.0	8.0	79	29	40	36	3.8	●
081-035-10 KI3	8.1	10.0	89	35	45	40	3.9	●
085-035-10 KI3	8.5	10.0	89	35	45	40	4.1	●
087-035-10 KI3	8.7	10.0	89	35	45	40	4.2	●
089-035-10 KI3	8.9	10.0	89	35	45	40	4.3	●
090-035-10 KI3	9.0	10.0	89	35	45	40	4.3	●
095-035-10 KI3	9.5	10.0	89	35	45	40	4.6	●
100-035-10 KI3	10.0	10.0	89	35	45	40	4.8	●
103-040-12 KI3	10.3	12.0	102	40	53	45	4.9	●
105-040-12 KI3	10.5	12.0	102	40	53	45	5.0	●
110-040-12 KI3	11.0	12.0	102	40	53	45	5.3	●
115-040-12 KI3	11.5	12.0	102	40	53	45	5.5	●
120-040-12 KI3	12.0	12.0	102	40	53	45	5.8	●



- Standard items

NHD...KI5



Solid carbide drills with oil holes for cast iron machining



• Drilling depth: 5x diameter

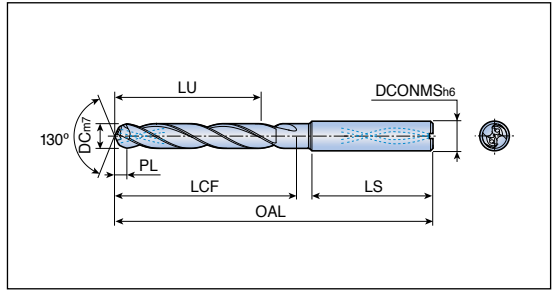

Designation	Dimension (mm)							Grade
	DC	DCONMS	OAL	LU	LCF	LS	PL	TT9030
NHD 030-023-06 KI5	3.0	6.0	66	23	27	34	1.4	●
033-023-06 KI5	3.3	6.0	66	23	27	34	1.6	●
035-023-06 KI5	3.5	6.0	66	23	27	34	1.7	●
040-029-06 KI5	4.0	6.0	74	29	34	35	1.9	●
042-029-06 KI5	4.2	6.0	74	29	34	35	2.0	●
045-029-06 KI5	4.5	6.0	74	29	35	35	2.2	●
046-029-06 KI5	4.6	6.0	74	29	35	35	2.2	●
050-035-06 KI5	5.0	6.0	82	35	43	36	2.4	●
052-035-06 KI5	5.2	6.0	82	35	43	36	2.5	●
055-035-06 KI5	5.5	6.0	82	35	43	36	2.6	●
060-035-06 KI5	6.0	6.0	82	35	43	36	2.9	●
065-043-08 KI5	6.5	8.0	91	43	52	36	3.1	●
067-043-08 KI5	6.7	8.0	91	43	52	36	3.2	●
068-043-08 KI5	6.8	8.0	91	43	52	36	3.3	●
070-043-08 KI5	7.0	8.0	91	43	52	36	3.4	●
075-043-08 KI5	7.5	8.0	91	43	52	36	3.6	●
080-043-08 KI5	8.0	8.0	91	43	52	36	3.8	●
081-049-10 KI5	8.1	10.0	103	49	59	40	3.9	●
085-049-10 KI5	8.5	10.0	103	49	59	40	4.1	●
087-049-10 KI5	8.7	10.0	103	49	59	40	4.2	●
089-049-10 KI5	8.9	10.0	103	49	59	40	4.3	●
090-049-10 KI5	9.0	10.0	103	49	59	40	4.3	●
095-049-10 KI5	9.5	10.0	103	49	59	40	4.6	●
100-049-10 KI5	10.0	10.0	103	49	59	40	4.8	●
103-056-12 KI5	10.3	12.0	118	56	69	45	4.9	●
105-056-12 KI5	10.5	12.0	118	56	69	45	5.0	●
110-056-12 KI5	11.0	12.0	118	56	69	45	5.3	●
115-056-12 KI5	11.5	12.0	118	56	69	45	5.5	●
120-056-12 KI5	12.0	12.0	118	56	69	45	5.8	●

●: Standard items



T-CHAMFER...T1

Chamfering tools with solid carbide drill

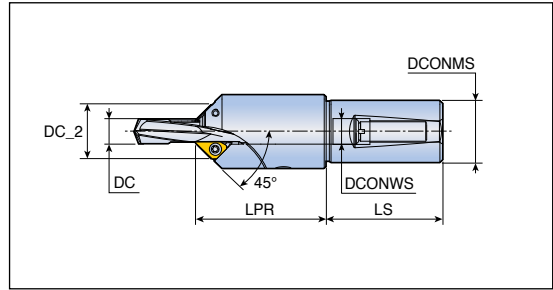

Designation	DC	Dimension (mm)					Insert
		DCONWS	DC_2	DCONMS	LPR	LS	
T-CHAMFER 080-20T1-06	7.1-8.0	8	18.8	20	47.4	50	XCGT 06...-C..
090-20T1-06	8.1-9.0	9	19.8	20	47.4	50	D178
100-32T1-09	9.1-10.0	10	24.9	32	67.3	60	XCGT 09...-C..
110-32T1-09	10.1-11.0	11	25.9	32	67.3	60	D178
120-32T1-09	11.1-12.0	12	26.9	32	67.3	60	
130-32T1-09	12.1-13.0	13	27.9	32	67.3	60	
140-32T1-09	13.1-14.0	14	28.4	32	67.3	60	
150-32T1-09	14.1-15.0	15	29.4	32	67.3	60	
160-32T1-09	15.1-16.0	16	30.4	32	67.3	60	
170-32T1-09	16.1-17.0	17	31.4	32	67.3	60	
180-32T1-09	17.1-18.0	18	32.4	32	67.3	60	
190-32T1-09	18.1-19.0	19	33.4	32	75.0	60	
200-32T1-09	19.1-20.0	20	34.4	32	75.0	60	

Spare parts

Designation	Side screw	Back screw	L-wrench	Insert screw	Wrench
T-CHAMFER 080 - 090	SS M6x1x6	M6x1-SP	L-W 3	TS 25064I	TD 8
T-CHAMFER 100 - 200	SS M10x1.5x10	M10x1.5-SP	L-W 5	TS 40093I	TD 15



SHD 3...-CF



Solid carbide drills for T-CHAMFER

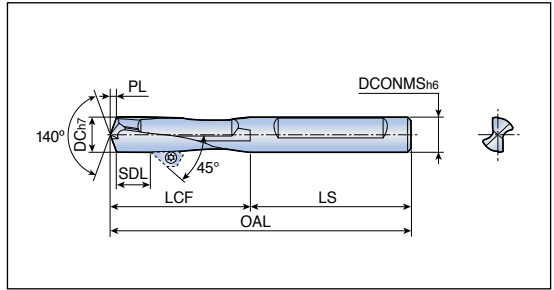

Designation	Dimension (mm)								Grade
	DC	DCONMS	OAL	LCF	LS	SDL _{min}	SDL _{max}	PL	
SHD 3080-CF	8.0	8.0	80.3	37.3	43	9.5	17.5	1.3	●
3090-CF	9.0	9.0	85.4	42.4	43	13.0	23.5	1.4	●
3100-CF	10.0	10.0	90.6	47.6	43	15.5	25.0	1.6	●
3110-CF	11.0	11.0	96.8	53.8	43	21.5	30.0	1.8	●
3120-CF	12.0	12.0	103.9	60.9	43	25.5	37.0	1.9	●
3130-CF	13.0	13.0	104.1	61.1	43	25.5	35.0	2.1	●
3150-CF	15.0	15.0	113.4	65.4	48	26.5	40.5	2.4	●
3170-CF	17.0	17.0	121.7	71.7	50	24.5	44.0	2.7	●
3180-CF	18.0	18.0	125.9	75.9	50	26.5	48.0	2.9	●
3190-CF	19.0	19.0	130.0	76	54	26.5	49.0	3.0	●

- 'SDL' is factored with a 45° insert positioned in insert pocket
- Solid carbide drill with internal coolant holes is available on request
- : Standard items

Insert	Chamfer angle (°)	Chamfer size
XCGT 0603-C30	30°	1.5
0603-C45	45°	4.5
0603-C60	60°	2.5
XCGT 0903-C30	30°	1.5
0903-C45	45°	6.0
0903-C60	60°	3.5

• The maximum chamfer size is obtained when using the smallest drill diameter in the drilling range

TCAP...-2.25DN



Multi-function toolholders - 2.25xD



- Internal coolant

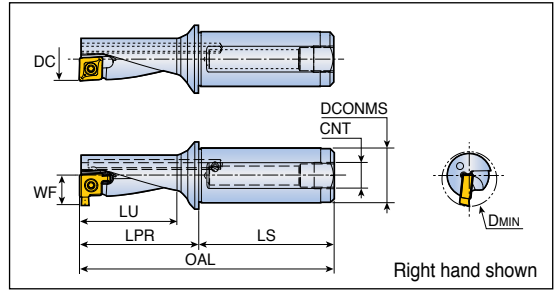
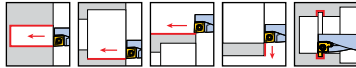

Designation	Dimension (mm)								Insert	
	DC	DCONMS	WF	LU	LPR	LS	DMIN	CNT	For drilling, boring, turning	For grooving
TCAP 08R/L-2.25DN	8	12	-	18.0	22.5	42	-	G 1/16	XCM(G)T 04...TC/TA	-
10R/L-2.25DN-GV	10	12	7.1	22.5	27.5	42	12.0	G 1/16	XCM(G)T 05...TC/TA	XCMT 05R...GV
12R/L-2.25DN-GV	12	16	8.5	27.0	33.0	45	14.5	G 1/8	XCM(G)T 06...TC/TA	XCMT 06R...GV
14R/L-2.25DN-GV	14	16	9.5	31.5	38.5	45	16.5	G 1/8	XCM(G)T 07...TC/TA	XCMT 07R...GV
16R/L-2.25DN-GV	16	20	11.1	36.0	44.0	50	19.0	G 1/8	XCM(G)T 08...TC/TA	XCMT 08R...GV
20R/L-2.25DN-GV	20	25	13.2	45.0	55.0	56	23.5	G 1/8	XCM(G)T 10...TC/TA	XCMT 10R...GV
25R/L-2.25DN-GV	25	32	16.5	56.2	69.0	61	29.0	G 1/8	XCM(G)T 13...TC/TA	XCMT 13R...GV
32R/L-2.25DN-GV	32	40	20.5	72.0	86.0	74	36.5	G 1/8	XCM(G)T 17...TC/TA	XCMT 17R...GV
									D179-180	D179

- $OAL = LPR + LS$
- Grooving insert is available for right handed type

Spare parts

Designation	Screw	Wrench	
TCAP 08	TS 18034I/HG-P	T 6P	
TCAP 10	TS 20038I/HG-P	T 6P	
TCAP 12	TS 22052I/HG-P	T 7P	
TCAP 14	TS 25064I/HG-P	T 8P	
TCAP 16	TS 30100I/HG-P		TD 9P
TCAP 20	TS 35088I/HG-P		TD10P
TCAP 25	TS 45A100I/HG		TD 20
TCAP 32	TS 45A100I/HG		TD 20



TCAP...-3.0DN



Multi-function toolholders - 3.0xD



• Internal coolant

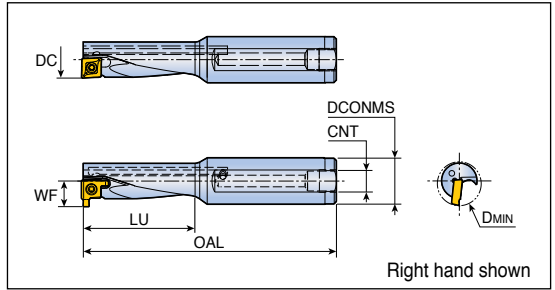
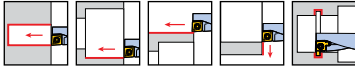

Designation	Dimension (mm)							Insert	
	DC	DCONMS	WF	LU	OAL	DMIN	CNT	For drilling, boring, turning	For grooving
TCAP 08R/L-3.0DN12	8	12	-	24	80	-	G 1/16	XCM(G)T 04...TC/TA	-
10R/L-3.0DN-GV	10	12	7.1	30	85	12.0	G 1/16	XCM(G)T 05...TC/TA	XCMT 05R...GV
12R/L-3.0DN-GV	12	16	8.5	36	95	14.5	G 1/8	XCM(G)T 06...TC/TA	XCMT 06R...GV
14R/L-3.0DN-GV	14	16	9.5	42	100	16.5	G 1/8	XCM(G)T 07...TC/TA	XCMT 07R...GV
16R/L-3.0DN-GV	16	20	11.1	48	110	19.0	G 1/8	XCM(G)T 08...TC/TA	XCMT 08R...GV
20R/L-3.0DN-GV	20	25	13.2	60	130	23.5	G 1/8	XCM(G)T 10...TC/TA	XCMT 10R...GV
25R/L-3.0DN-GV	25	32	16.5	75	150	29.0	G 1/8	XCM(G)T 13...TC/TA	XCMT 13R...GV
32R/L-3.0DN-GV	32	40	20.5	96	185	36.5	G 1/8	XCM(G)T 17...TC/TA	XCMT 17R...GV
								D179-180	D179

- OAL = LPR+LS
- Grooving insert is available for right handed type

Spare parts

Designation	Screw	Wrench	
TCAP 08	TS 18034I/HG-P	T 6P	
TCAP 10	TS 20038I/HG-P	T 6P	
TCAP 12	TS 22052I/HG-P	T 7P	
TCAP 14	TS 25064I/HG-P	T 8P	
TCAP 16	TS 30100I/HG-P		TD 9P
TCAP 20	TS 35088I/HG-P		TD10P
TCAP 25	TS 45A100I/HG		TD 20
TCAP 32	TS 45A100I/HG		TD 20



S...SXUCR/L



Boring bars with TOP-CAP inserts



- For boring
- External coolant

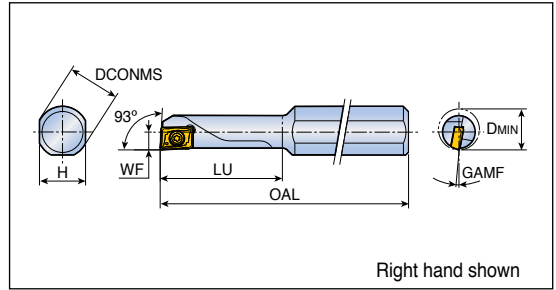
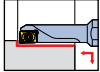

Designation	Dimension (mm)							Insert
	DCONMS	H	OAL	LU	WF	DMIN	GAMF	
S10H SXUCR/L 04-06 ⁽¹⁾	10	9	100	21	3.0	6	9°	XCMT 04...R/L TC
S10J SXUCR/L 04-07 ⁽¹⁾	10	9	110	24.5	3.5	7	5°	D180
S10J SXUCR/L 04-08 ⁽¹⁾	10	9	110	28	4.0	8	2°	
S10K SXUCR/L 05-10	10	9	125	35	5.0	10	2°	XCMT 05..TC D180

⁽¹⁾ Right hand Insert should be used in right hand boring bar

Spare parts

Designation	Screw	Wrench		
S10H SXUCR/L 04-06	TS 18034I/HG-P	T 6P		
S10J SXUCR/L 04-07	TS 18034I/HG-P	T 6P		
S10J SXUCR/L 04-08	TS 18034I/HG-P	T 6P		
S10K SXUCR/L 05-10	TS 20038I/HG-P	T 6P		



Clamping units (Centre alignment system)

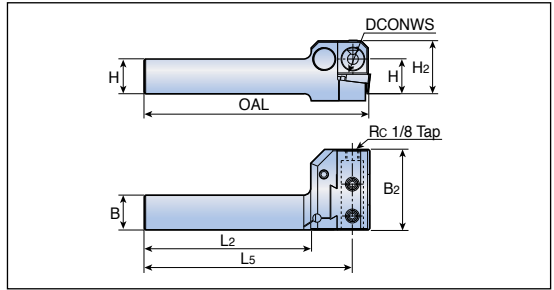

Designation	Dimension (mm)								Toolholders
	H	B	DCONWS	H ₂	B ₂	L ₂	L ₅	OAL	
TGHR 2020-D16	20	20	16	38	58	120	150	161	TCAP 08R/L... TCAP 10R/L... TCAP 12R/L... TCAP 14R/L...
2525-D16	25	25	16	38	58	120	150	161	
2525-D25	25	25	25	56	75	120	157	174	TCAP 16R/L... TCAP 20R/L...

Spare parts

Designation	Block	Wedge	Snap ring	Wedge screw	Mounting pin	Mounting pin screw	Mounting screw		Lock screw	Wrench
TGHR 2020-D16 TGHR 2525-D16	TGHR-D16-BL	TGHR-WD	WSR 4	TGH-WS	TGH-MPI	TGH-MPS	SSxM8 1.25X10-C	SSxM8 x1.25x8	-	L-W 4
TGHR 2525-D25	TGHR-D25-BL	TGHR-WD-25	WSR 4	TGH-WS-25	TGH-MPI-25	TGH-MPS-25	SS M10 x1.5x12-C	SS M101.5x10	SH M6x1x20	L-W 4 L-W 5

Sleeves for clamping unit

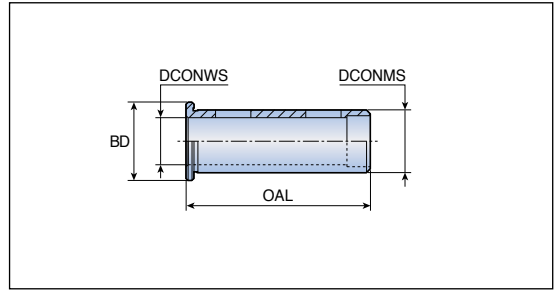

Designation	Dimension (mm)				Toolholders
	DCONMS	DCONWS	BD	OAL	
TSL 16-12	16	12	20	47	TCAP 10R/L...
25-20	25	20	32	55	TCAP 16R/L...

TBSL

Sleeves for boring bar

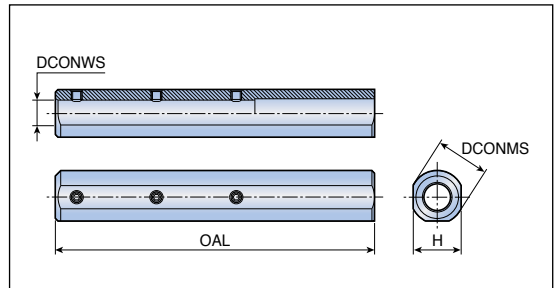

Designation	Dimension (mm)			
	DCONMS	DCONWS	OAL	H
TBSL 20-10-120	20	10	120	18

Spare parts

Designation	Screw	Wrench		
TBSL 20-10-120	SS M4x0.7x4	L-W 2		

TSL-NC

Drill sleeves for Swiss type automatic lathes (Fixed type, internal coolant)

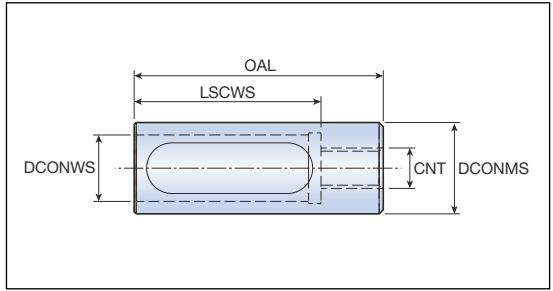

Designation	Dimension (mm)				
	DCONMS	DCONWS	LSCWS	OAL	CNT
TSL-NC 19.05-12	19.05	12.0	45	60	Rc 1/8
19.05-16	19.05	16.0	45	60	Rc 1/8
20-12	20.0	12.0	45	60	Rc 1/8
20-16	20.0	16.0	45	60	Rc 1/8
22-16	22.0	16.0	45	60	Rc 1/8
25-20	25.0	20.0	45	60	Rc 1/8
25.4-20	25.4	20.0	45	60	Rc 1/8
32-25	32.0	25.0	45	60	Rc 1/8

TSL-SW

Drill sleeves for Swiss type automatic lathes (Adjustable type, internal coolant)

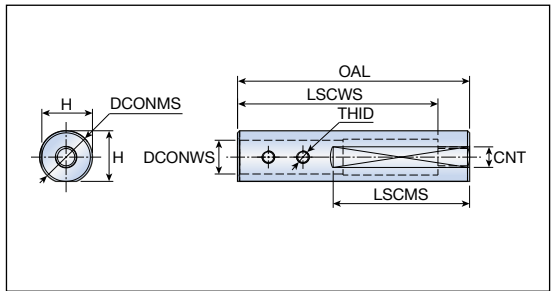

Designation	Dimension (mm)							
	DCONMS	DCONWS	LSCWS	LSCMS	OAL	H	THID	CNT
TSL-SW 22-12	22.0	12.0	95	65	110	21.0	M6	Rc 1/8
25-12	25.0	12.0	95	65	110	24.0	M8	Rc 1/8
25-16	25.0	16.0	95	65	110	24.0	M6	Rc 1/8
25.4-12	25.4	12.0	95	65	110	24.4	M8	Rc 1/8
25.4-16	25.4	16.0	95	65	110	24.4	M6	Rc 1/8
32-12	32.0	12.0	95	65	110	31.0	M8	Rc 1/8
32-16	32.0	16.0	95	65	110	31.0	M8	Rc 1/8
32-20	32.0	20.0	95	65	110	31.0	M8	Rc 1/8

Accessories

Hose set

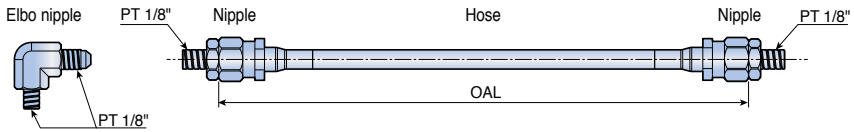



* Hose set components: 1 hose, 2 nipples, 1 elbo nipple

Designation	Dimension (mm)	
	OAL (mm)	Max. pressure (bar)
S-TSL HOSE R1/8-220	220	100
R1/8-350	350	100

• Hose set is ordered separately

Spare parts

Designation	Mounting screw	Wrench		
				
TSL-SW 22-12	SS M6X1X5	L-W 3		
TSL-SW 25-12	SS M8X1.25X6	L-W 4		
TSL-SW 25-16	SS M6X1X5	L-W 3		
TSL-SW 25.4-12	SS M8X1.25X6	L-W 4		
TSL-SW 25.4-16	SS M6X1X5	L-W 3		
TSL-SW 32-12	SS M8X1.25X6	L-W 4		
TSL-SW 32-16	SS M8X1.25X6	L-W 4		
TSL-SW 32-20	SS M8X1.25X6	L-W 4		

Deep Drilling Tools



Assembly of TBTA3 series

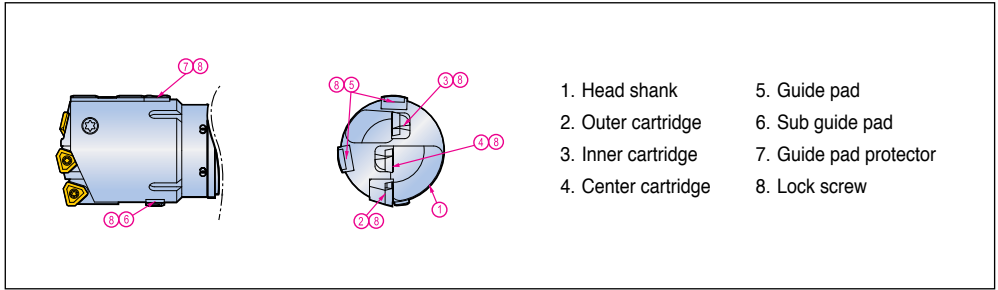

Parts		Diameter (mm)				
		38.00-39.99	40.00-44.99	45.00-47.99	48.00-51.99	52.00-54.99
Cartridge	Outer	PERC 05R	PERC 402-04	PERC 402-04	PERC 402-04	PERC 402-32
	Adjust screw	AS0003-5	AS0004-8	AS0004-8	AS0004-8	AS0005-10
	Wrench	H1.5	H2	H2	H2	H2.5
	Screw	LS1803RH	LS1803.5RH	LS1803.5RH	LS1803.5RH	LS1805RH
	Wrench	H2	H2.5	H2.5	H2.5	H3
	Inner	CENC 05R	CENC 05R	CENC 05R	CENC 402-04	CENC 402-04
	Screw	CSTB3	CSTB3	CSTB3	CSTB3.5	CSTB3.5
	Wrench	T-9D	T-9D	T-9D	T-15D	T-15D
	Center	CENC 05R	CENC 05R	CENC 402-04	CENC 402-04	CENC 402-04
	Screw	CSTB3	CSTB3	CSTB3.5	CSTB3.5	CSTB3.5
Wrench	T-9D	T-9D	T-15D	T-15D	T-15D	
Insert	Outer	NPMX 080308R-G	TPMX 140308R-G	TPMX 140308R-G	TPMX 140308R-G	TPMX 170408R-G
	Screw	CSTB2.2	CSTB2.5	CSTB2.5	CSTB2.5	CSTB3.5D
	Wrench	T-7D	T-8D	T-8D	T-8D	T-9D
	Inner	NPMX 080308R-G	NPMX 080308R-G	NPMX 080308R-G	TPMX 140308R-G	TPMX 140308R-G
	Screw	CSTB2.2	CSTB2.2	CSTB2.2	CSTB2.5	CSTB2.5
	Wrench	T-7D	T-7D	T-7D	T-8D	T-8D
	Center	NPMX 080308R-G	NPMX 080308R-G	TPMX 140308R-G	TPMX 140308R-G	TPMX 140308R-G
Screw	CSTB2.2	CSTB2.2	CSTB2.5	CSTB2.5	CSTB2.5	
Wrench	T-7D	T-7D	T-8D	T-8D	T-8D	
Pad	Guide pad	PAD-GP08-25-155-DC-SB PAD-GP08-25-155-DC-SC	PAD-GP08-25-155-DC-SB PAD-GP08-25-155-DC-SC	PAD-GP10-35-200-DC-SB PAD-GP10-35-200-DC-SC	PAD-GP10-35-200-DC-SB PAD-GP10-35-200-DC-SC	PAD-GP10-35-200-DC-SB PAD-GP10-35-200-DC-SC
	Screw	CSTB3S	CSTB3S	CSTB4S	CSTB4S	CSTB4S
	Wrench	T-9D	T-9D	T-15D	T-15D	T-15D
	Guide pad protector	PAD-P08	PAD-P08	PAD-P10	PAD-P10	PAD-P10
	Screw	CSTB3S	CSTB3S	CSTB4S	CSTB4S	CSTB4S
	Wrench	T-9D	T-9D	T-15D	T-15D	T-15D
	Sub guide pad	PAD-S08	PAD-S08	PAD-S08	PAD-S08	PAD-S08
	Screw	CSTB3S	CSTB3S	CSTB3S	CSTB3S	CSTB3S
	Wrench	T-9D	T-9D	T-9D	T-9D	T-9D



TBTA3 Series



Assembly of TBTA3 series

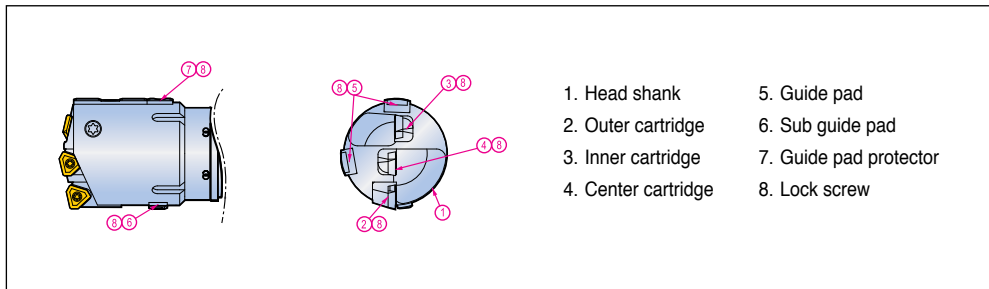

- 1. Head shank
- 2. Outer cartridge
- 3. Inner cartridge
- 4. Center cartridge
- 5. Guide pad
- 6. Sub guide pad
- 7. Guide pad protector
- 8. Lock screw

Parts	Diameter (mm)					
	55.00-57.99	58.00-59.99	60.00-63.99	64.00-67.99	68.00-77.99	
Cartridge	Outer	PERC 402-32	PERC 402-32	PERC 402-32	PERC 402-43	PERC 402-32
	Adjust screw	AS0005-10	AS0005-10	AS0005-10	AS0005-15	AS0005-10
	Wrench	H2.5	H2.5	H2.5	H2.5	H2.5
	Screw	LS1805RH	LS1805RH	LS1805RH	LS1806RH	LS1805RH
	Wrench	H3	H3	H3	H4	H3
	Inner	CENC 402-04	CENC 402-32	CENC 402-32	CENC 402-32	CENC 402-43
	Screw	CSTB3.5	CSTA5	CSTA5	CSTA5	LS1206
	Wrench	T-15D	T-15D	T-15D	T-15D	H3
	Center	CENC 402-32	CENC 402-32	CENC 402-32	CENC 402-32	CENC 402-43
	Screw	CSTA5	CSTA5	CSTA5	CSTA5	LS1206
Wrench	T-15D	T-15D	T-15D	T-15D	H3	
Insert	Outer	TPMX 170408R-G	TPMX 170408R-G	TPMX 170408R-G	TPMX 240512R-G	TPMX 170408R-G
	Screw	CSTB3.5D	CSTB3.5D	CSTB3.5D	CSTB4M	CSTB3.5D
	Wrench	T-9D	T-9D	T-9D	T-15D	T-9D
	Inner	TPMX 140308R-G	TPMX 170408R-G	TPMX 170408R-G	TPMX 170408R-G	TPMX 240512R-G
	Screw	CSTB2.5	CSTB3.5D	CSTB3.5D	CSTB3.5D	CSTB4M
	Wrench	T-8D	T-9D	T-9D	T-9D	T-15D
	Center	TPMX 170408R-G	TPMX 170408R-G	TPMX 170408R-G	TPMX 170408R-G	TPMX 240512R-G
Screw	CSTB3.5D	CSTB3.5D	CSTB3.5D	CSTB3.5D	CSTB4M	
Wrench	T-9D	T-9D	T-9D	T-9D	T-15D	
Pad	Guide pad	PAD-GP10-35-200-DC-SB PAD-GP10-35-200-DC-SC	PAD-GP10-35-200-DC-SB PAD-GP10-35-200-DC-SC	PAD-GP14-40-250-DC-SB PAD-GP14-40-250-DC-SC	PAD-GP14-40-250-DC-SB PAD-GP14-40-250-DC-SC	PAD-GP14-40-250-DC-SB PAD-GP14-40-250-DC-SC
	Screw	CSTB4S	CSTB4S	CSTA5S	CSTA5S	CSTA5S
	Wrench	T-15D	T-15D	T-15D	T-15D	T-15D
	Guide pad protector	PAD-P10	PAD-P10	PAD-P14	PAD-P14	PAD-P14
	Screw	CSTB4S	CSTB4S	CSTA5S	CSTA5S	CSTA5S
	Wrench	T-15D	T-15D	T-15D	T-15D	T-15D
	Sub guide pad	PAD-S08	PAD-S08	PAD-S08	PAD-S10	PAD-S10
	Screw	CSTB3S	CSTB3S	CSTB3S	CSTB3S	CSTB3S
	Wrench	T-9D	T-9D	T-9D	T-9D	T-9D



Assembly of TBTA3 series

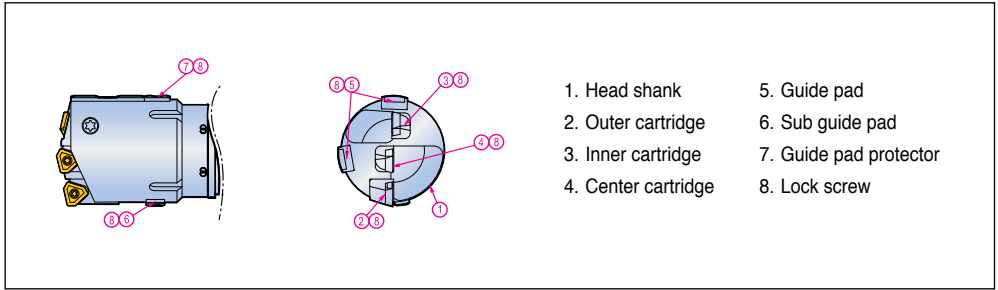

- | | |
|---------------------|------------------------|
| 1. Head shank | 5. Guide pad |
| 2. Outer cartridge | 6. Sub guide pad |
| 3. Inner cartridge | 7. Guide pad protector |
| 4. Center cartridge | 8. Lock screw |

Parts		Diameter (mm)			
		78.00-84.99	85.00-91.99	92.00-98.99	99.00-106.99
Cartridge	Outer	PERC 402-43	PERC 402-63	PERC 402-43	PERC 402-63
	Adjust screw	AS0005-15	AS0006-15	AS0005-15	AS0006-15
	Wrench	H2.5	H3	H2.5	H3
	Screw	LS1806RH	LS1806RH	LS1806RH	LS1806RH
	Wrench	H4	H4	H4	H4
	Inner	CENC 402-43	CENC 402-43	CENC 402-63	CENC 402-63
	Screw	LS1206	LS1206	LS1206	LS1206
	Wrench	H3	H3	H3	H3
	Center	CENC 402-43	CENC 402-43	CENC 402-63	CENC 402-63
	Screw	LS1206	LS1206	LS1206	LS1206
Insert	Outer	TPMX 240512R-G	TPMX 280716R-G	TPMX 240512R-G	TPMX 280716R-G
	Screw	CSTB4M	CSTB5	CSTB4M	CSTB5
	Wrench	T-15D	T-20D	T-15D	T-20D
	Inner	TPMX 240512R-G	TPMX 240512R-G	TPMX 280716R-G	TPMX 280716R-G
	Screw	CSTB4M	CSTB4M	CSTB5	CSTB5
	Wrench	T-15D	T-15D	T-20D	T-20D
	Center	TPMX 240512R-G	TPMX 240512R-G	TPMX 280716R-G	TPMX 280716R-G
	Screw	CSTB4M	CSTB4M	CSTB5	CSTB5
	Wrench	T-15D	T-15D	T-20D	T-20D
	Pad	Guide pad	PAD-GP14-40-250-DC-SB PAD-GP14-40-250-DC-SC	PAD-GP14-40-250-DC-SB PAD-GP14-40-250-DC-SC	PAD-GP14-40-250-DC-SB PAD-GP14-40-250-DC-SC
Screw		CSTA5S	CSTA5S	CSTA5S	LS1206S
Wrench		T-15D	T-15D	T-15D	H3
Guide pad protector		PAD-P14	PAD-P14	PAD-P14	PAD-P18
Screw		CSTB5S	CSTB5S	CSTA5S	LS1206S
Wrench		T-15D	T-15D	T-15D	H3
Sub guide pad		PAD-S10	PAD-S10	PAD-S10	PAD-S14
Screw		CSTB3S	CSTB3S	CSTB3S	CSTA5S
Wrench		T-9D	T-9D	T-9D	T-15D



TBTA5...SE4



Single tube system

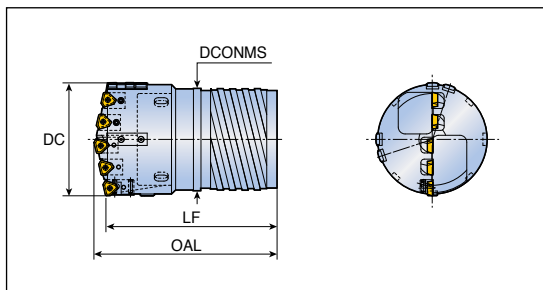

- Outer four start thread

Designation	DC	Dimension (mm)			Tube	
		LF	OAL	DCONMS	Part	Diameter (mm)
TBTA5- xxx.xxSE4-094	107.00-111.99	180	197	89	BTSI 094	94
xxx.xxSE4-106	112.00-123.99	205	221	101	BTSI 106	106
xxx.xxSE4-118	124.00-135.99	205	222	113	BTSI 118	118
xxx.xxSE4-130	136.00-147.99	205	223	125	BTSI 130	130
xxx.xxSE4-142	148.00-159.99	225	245	137	BTSI 142	142
xxx.xxSE4-154	160.00-168.99	225	246	149	BTSI 154	154

TBTA5...SI1



Single tube system

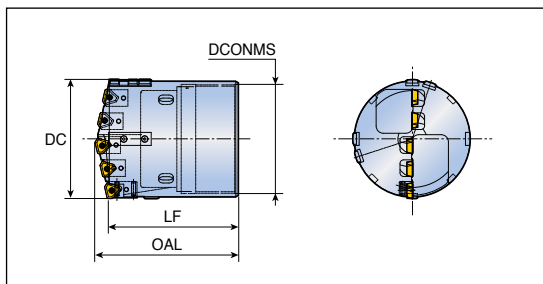

- Inner single start thread

Designation	DC	Dimension (mm)			Tube	
		LF	OAL	DCONMS	Part	Diameter (mm)
TBTA5- xxx.xxSI1-094	107.00-110.99	150	164	90	BTSE 094	94
xxx.xxSI1-106	111.00-122.99	150	165	102	BTSE 106	106
xxx.xxSI1-118	123.00-134.99	150	167	114	BTSE 118	118
xxx.xxSI1-130	135.00-148.99	150	168	126	BTSE 130	130
xxx.xxSI1-142	149.00-161.99	150	170	139	BTSE 142	142
xxx.xxSI1-154	162.00-168.99	190	211	151	BTSE 154	154

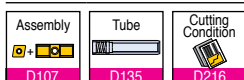

TBTA5 Series



Assembly of TBTA5 series

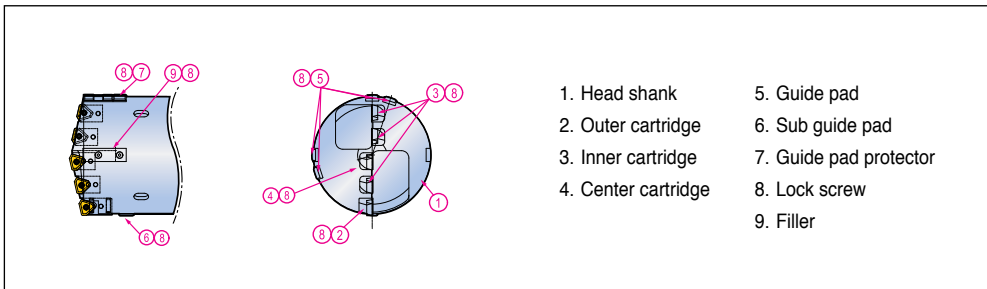

Parts	Diameter (mm)				
	107.00-117.99	118.00-135.99	136.00-144.99	145.00-150.99	
Cartridge	Outer	PERC 402-43	PERC 402-43	PERC 402-43	PERC 402-43
	Adjust screw	AS0005-15	AS0005-15	AS0005-15	AS0005-15
	Wrench	H2.5	H2.5	H2.5	H2.5
	Screw	LS1806RH	LS1806RH	LS1806RH	LS1806RH
	Wrench	H4	H4	H4	H4
	Inner	CENC 402-32	CENC 402-43	CENC 402-43	CENC 402-43
	Screw	CSTA5	LS1206	LS1206	LS1206
	Wrench	T-15D	H3	H3	H3
	Center	CENC 402-43	CENC 402-43	CENC 402-63	CENC 402-63
	Screw	LS1206	LS1206	LS1206	LS1206
Insert	Wrench	H3	H3	H3	H3
	Outer	TPMX 240512R-G	TPMX 240512R-G	TPMX 240512R-G	TPMX 240512R-G
	Screw	CSTB4M	CSTB4M	CSTB4M	CSTB4M
	Wrench	T-15D	T-15D	T-15D	T-15D
	Inner	TPMX 170408R-G	TPMX 240512R-G	TPMX 240512R-G	TPMX 240512R-G
	Screw	CSTB3.5D	CSTB4M	CSTB4M	CSTB4M
	Wrench	T-9D	T-15D	T-15D	T-15D
Center	TPMX 240512R-G	TPMX 240512R-G	TPMX 280716R-G	TPMX 280716R-G	
Pad	Screw	CSTB4M	CSTB4M	CSTB5	CSTB5
	Wrench	T-15D	T-15D	T-20D	T-20D
	Guide pad	PAD-GP18-40-300-DC-SB	PAD-GP18-40-300-DC-SB	PAD-GP18-40-300-DC-SB	PAD-GP18-40-300-DC-SB
	Screw	PAD-GP18-40-300-DC-SC	PAD-GP18-40-300-DC-SC	PAD-GP18-40-300-DC-SC	PAD-GP18-40-300-DC-SC
	Wrench	LS1206S	LS1206S	LS1206S	LS1206S
	Guide pad protector	H3	H3	H3	H3
	Screw	PAD-P18	PAD-P18	PAD-P18	PAD-P18
	Wrench	LS1206S	LS1206S	LS1206S	LS1206S
	Sub guide pad	H3	H3	H3	H3
	Screw	PAD-S14	PAD-S14	PAD-S14	PAD-S14
Wrench	CSTA5S	CSTA5S	CSTA5S	CSTA5S	
	T-15D	T-15D	T-15D	T-15D	



Assembly of TBTA5 series

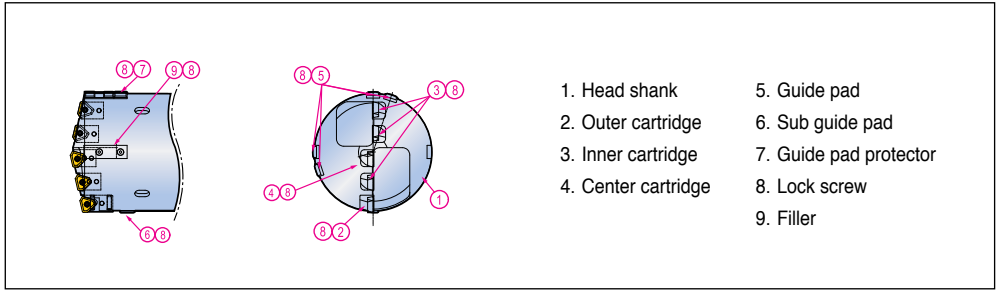

Parts		Diameter (mm)		
		151.00-156.99	157.00-162.99	163.00-168.99
Cartridge	Outer	PERC 402-63	PERC 402-63	PERC 402-63
	Adjust screw	AS0006-15	AS0006-15	AS0006-15
	Wrench	H3	H3	H3
	Screw	LS1806RH	LS1806RH	LS1806RH
	Wrench	H4	H4	H4
	Inner	CENC 402-43	CENC 402-43	CENC 402-63
	Screw	LS1206	LS1206	LS1206
	Wrench	H3L	H3L	H3L
	Center	CENC 402-63	CENC 402-63	CENC 402-63
	Screw	LS1206S	LS1206S	LS1206S
	Wrench	H3L	H3L	H3L
Insert	Outer	TPMX 280716R-G	TPMX 280716R-G	TPMX 280716R-G
	Screw	CSTB5	CSTB5	CSTB5
	Wrench	T-20D	T-20D	T-20D
	Inner	TPMX 240512R-G	TPMX 240512R-G	TPMX 280716R-G
	Screw	CSTB4M	CSTB4M	CSTB5
	Wrench	T-15D	T-15D	T-20D
	Center	TPMX 280716R-G	TPMX 280716R-G	TPMX 280716R-G
Pad	Screw	CSTB5	CSTB5	CSTB5
	Wrench	T-20D	T-20D	T-20D
	Guide pad	PAD-GP18-40-300-DC-SB	PAD-GP18-40-300-DC-SB	PAD-GP18-40-300-DC-SB
		PAD-GP18-40-300-DC-SC	PAD-GP18-40-300-DC-SC	PAD-GP18-40-300-DC-SC
	Screw	LS1206S	LS1206S	LS1206S
	Wrench	H3	H3	H3L
	Guide pad protector	PAD-P18	PAD-P18	PAD-P18
	Screw	LS1206S	LS1206S	LS1206S
	Wrench	H3	H3	H3
	Sub guide pad	PAD-S14	PAD-S14	PAD-S14
	Screw	CSTA5S	CSTA5S	CSTA5S
Wrench	T-15D	T-15D	T-15D	



TBTA7...SE4



Single tube system

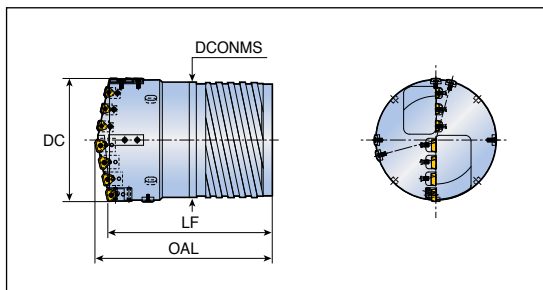

- Outer four start thread
- Double tube system also available on request

Designation	DC	Dimension (mm)			Tube	
		LF	OAL	DCONMS	Part	Diameter (mm)
TBTA7- xxx.xxSE4-154	169.00-171.99	225	246	149	BTSI 154	154
xxx.xxSE4-166	172.00-183.99	225	247	161	BTSI 166	166
xxx.xxSE4-178	184.00-195.99	245	267	173	BTSI 178	178
xxx.xxSE4-190	196.00-207.99	245	270	185	BTSI 190	190
xxx.xxSE4-202	208.00-219.99	245	271	197	BTSI 202	202
xxx.xxSE4-214	220.00-231.99	265	293	208	BTSI 214	214
xxx.xxSE4-226	232.00-232.99	265	293	220	BTSI 226	226

TBTA7...SI1



Single tube system

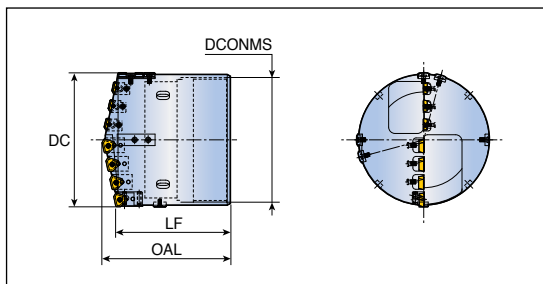

- Inner single start thread

Designation	DC	Dimension (mm)			Tube	
		LF	OAL	DCONMS	Part	Diameter (mm)
TBTA7- xxx.xxSI1-154	169.00-173.99	190	211	151	BTSE 154	154
xxx.xxSI1-166	174.00-185.99	190	213	163	BTSE 166	166
xxx.xxSI1-178	186.00-197.99	190	212	175	BTSE 178	178
xxx.xxSI1-190	198.00-209.99	190	215	187	BTSE 190	190
xxx.xxSI1-202	210.00-221.99	190	217	199	BTSE 202	202
xxx.xxSI1-214	222.00-232.99	190	218	211	BTSE 214	214

 Assembly D110	 Tube D135	 Cutting Condition D216
----------------------	------------------	-------------------------------

Assembly of TBTA7 series

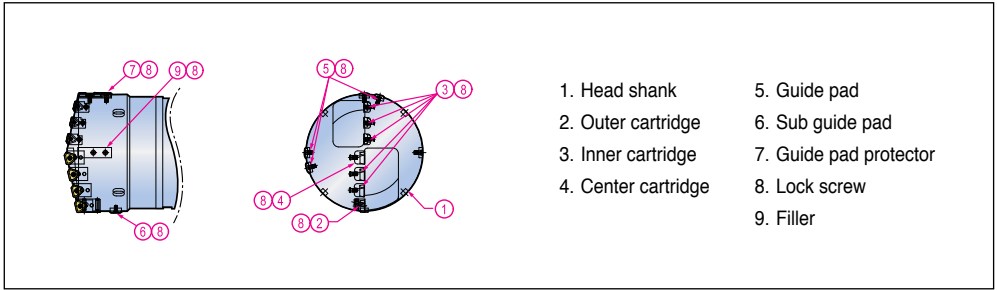

Parts		Diameter (mm)			
		169.00-188.99	189.00-196.99	197.00-202.99	203.00-208.99
Cartridge	Outer	PERC 402-43	PERC 402-43	PERC 402-43	PERC 402-43
	Adjust screw	AS0005-15	AS0005-15	AS0005-15	AS0005-15
	Wrench	H2.5	H2.5	H2.5	H2.5
	Screw	LS1806RH	LS1806RH	LS1806RH	LS1806RH
	Wrench	H4	H4	H4	H4
	Inner	CENC 402-43	CENC 402-43	CENC 402-43	CENC 402-43
	Screw	LS1206	LS1206	LS1206	LS1206
	Wrench	H3L	H3L	H3L	H3L
	Center	CENC 402-43	CENC 402-63	CENC 402-63	CENC 402-63
	Screw	LS1206	LS1206S	LS1206S	LS1206S
Insert	Outer	TPMX 240512R-G	TPMX 240512R-G	TPMX 240512R-G	TPMX 240512R-G
	Screw	CSTB4M	CSTB4M	CSTB4M	CSTB4M
	Wrench	T-15D	T-15D	T-15D	T-15D
	Inner	TPMX 240512R-G	TPMX 240512R-G	TPMX 240512R-G	TPMX 240512R-G
	Screw	CSTB4M	CSTB4M	CSTB4M	CSTB4M
	Wrench	T-15D	T-15D	T-15D	T-15D
	Center	TPMX 240512R-G	TPMX 280716R-G	TPMX 280716R-G	TPMX 280716R-G
Pad	Screw	CSTB4M	CSTB5	CSTB5	CSTB5
	Wrench	T-15D	T-15D	T-15D	T-15D
	Guide pad	PAD-GP18-40-300-DC-SB	PAD-GP18-40-300-DC-SB	PAD-GP18-40-300-DC-SB	PAD-GP18-40-300-DC-SB
	Screw	PAD-GP18-40-300-DC-SC	PAD-GP18-40-300-DC-SC	PAD-GP18-40-300-DC-SC	PAD-GP18-40-300-DC-SC
	Wrench	LS1206S	LS1206S	LS1206S	LS1206S
	Wrench	H3	H3	H3	H3
	Guide pad protector	PAD-P18	PAD-P18	PAD-P18	PAD-P18
	Screw	LS1206S	LS1206S	LS1206S	LS1206S
	Wrench	H3	H3	H3	H3
	Sub guide pad	PAD-S14	PAD-S14	PAD-S14	PAD-S14
Screw	CSTA5S	CSTA5S	CSTA5S	CSTA5S	
Wrench	T-15D	T-15D	T-15D	T-15D	



Assembly of TBTA7 series

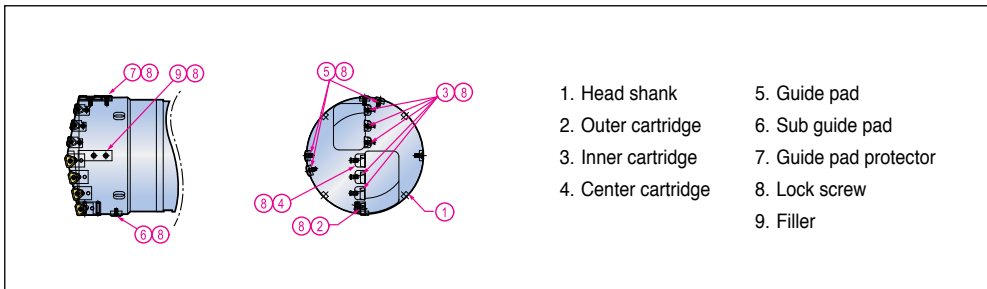

Parts		Diameter (mm)			
		209.00-214.99	215.00-220.99	221.00-226.99	227.00-232.99
Cartridge	Outer	PERC 402-63	PERC 402-63	PERC 402-63	PERC 402-63
	Adjust screw	AS0006-15	AS0006-15	AS0006-15	AS0005-15
	Wrench	H3	H3	H3	H3
	Screw	L1806RH	L1806RH	L1806RH	L1806RH
	Wrench	H4	H4	H4	H4
	Inner	CENC 402-43	CENC 402-43	CENC 402-43	CENC 402-63
	Screw	LS1206	LS1206	LS1206	LS1206
	Wrench	H3L	H3L	H3L	H3L
	Center	CENC 402-63	CENC 402-63	CENC 402-63	CENC 402-63
	Screw	LS1206S	LS1206	LS1206	LS1206S
Insert	Outer	TPMX 280716R-G	TPMX 280716R-G	TPMX 280716R-G	TPMX 280716R-G
	Screw	CSTB5	CSTB5	CSTB5	CSTB5
	Wrench	T-20D	T-20D	T-20D	T-20D
	Inner	TPMX 240512R-G	TPMX 240512R-G	TPMX 240512R-G	TPMX 280716R-G
	Screw	CSTB4M	CSTB4M	CSTB4M	CSTB5
	Wrench	T-15D	T-15D	T-15D	T-15D
	Center	TPMX 280716R-G	TPMX 280716R-G	TPMX 280716R-G	TPMX 280716R-G
Pad	Screw	CSTB5	CSTB5	CSTB5	CSTB5
	Wrench	T-20D	T-20D	T-20D	T-20D
	Guide pad	PAD-GP18-40-300-DC-SB	PAD-GP18-40-300-DC-SB	PAD-GP18-40-300-DC-SB	PAD-GP18-40-300-DC-SB
		PAD-GP18-40-300-DC-SC	PAD-GP18-40-300-DC-SC	PAD-GP18-40-300-DC-SC	PAD-GP18-40-300-DC-SC
	Screw	LS1206S	LS1206S	LS1206S	LS1206S
	Wrench	H3	H3	H3	H3
	Guide pad protector	PAD-P18	PAD-P18	PAD-P18	PAD-P18
	Screw	LS1206S	LS1206S	LS1206S	LS1206S
	Wrench	H3	H3	H3	H3
	Sub guide pad	PAD-S14	PAD-S14	PAD-S14	PAD-S14
Screw	CSTA5S	CSTA5S	CSTA5S	CSTA5S	
Wrench	T-15D	T-15D	T-15D	T-15D	



TBTA9...SE4



Single tube system

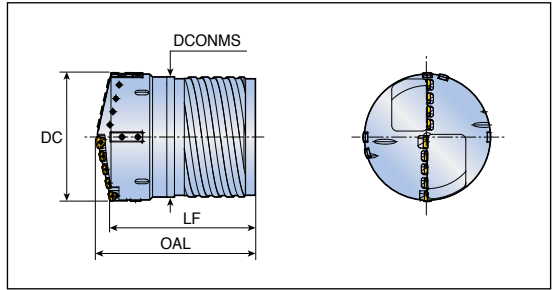

- Outer four start thread

Designation	DC	Dimension (mm)			Tube	
		LF	OAL	DCONMS	Part	Diameter (mm)
TBTA9 - xxx.xxSE4-226	233.00-243.99	265	294	220	BTSI 226	226
xxx.xxSE4-238	244.00-255.99	265	294	232	BTSI 238	238
xxx.xxSE4-250	256.00-267.99	290	322	244	BTSI 250	250
xxx.xxSE4-262	268.00-279.99	290	323	256	BTSI 262	262
xxx.xxSE4-274	280.00-291.99	290	325	268	BTSI 274	274

TBTA9...SI1



Single tube system

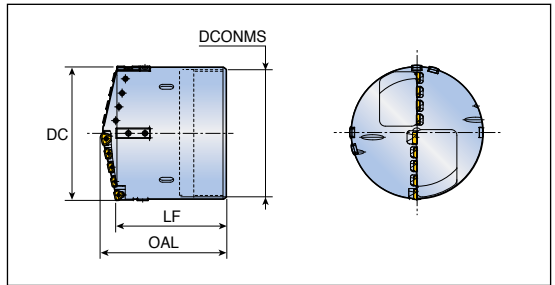

- Inner single start thread

Designation	DC	Dimension (mm)			Tube	
		LF	OAL	DCONMS	Part	Diameter (mm)
TBTA9 - xxx.xxSI1-214	233.00-233.99	190	217	211	BTSE 214	214
xxx.xxSI1-226	234.00-245.99	190	219	223	BTSE 226	226
xxx.xxSI1-238	246.00-257.99	190	221	235	BTSE 238	238
xxx.xxSI1-250	258.00-269.99	210	242	245	BTSE 250	250
xxx.xxSI1-262	270.00-281.99	210	244	259	BTSE 262	262
xxx.xxSI1-274	282.00-293.99	210	245	271	BTSE 274	274

Assembly	Tube	Cutting Condition
D113	D135	D216

TBTA9 Series



Assembly of TBTA9 series

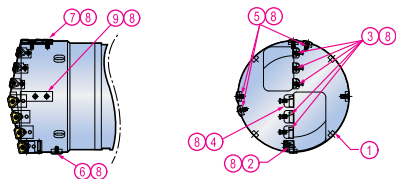

1. Head shank
2. Outer cartridge
3. Inner cartridge
4. Center cartridge
5. Guide pad
6. Sub guide pad
7. Guide pad protector
8. Lock screw
9. Filler

Parts		Diameter (mm)				
		233.00-247.99	248.00-253.99	254.00-258.99	259.00-264.99	265.00-271.99
Cartridge	Outer	PERC 402-43	PERC 402-63	PERC 402-63	PERC 402-63	PERC 402-63
	Adjust screw	AS0005-15	AS0006-15	AS0006-15	AS0006-15	AS0006-15
	Wrench	H2.5	H3	H3	H3	H3
	Screw	LS1806RH	L1806RH	L1806RH	L1806RH	L1806RH
	Wrench	H4	H4	H4	H4	H4
	Inner	CENC 402-43	CENC 402-43	CENC 402-43	CENC 402-43	CENC 402-43
	Screw	LS1206	LS1206	LS1206	LS1206	LS1206
	Wrench	H3L	H3L	H3L	H3L	H3L
	Center	CENC 402-63	CENC 402-63	CENC 402-63	CENC 402-63	CENC 402-63
	Screw	LS1206S	LS1206S	LS1206S	LS1206S	LS1206S
Insert	Outer	TPMX 240512R-G	TPMX 280716R-G	TPMX 280716R-G	TPMX 280716R-G	TPMX 280716R-G
	Screw	CSTB4M	CSTB5	CSTB5	CSTB5	CSTB5
	Wrench	T-15D	T-20D	T-20D	T-20D	T-20D
	Inner	TPMX 240512R-G	TPMX 240512R-G	TPMX 240512R-G	TPMX 240512R-G	TPMX 240512R-G
	Screw	CSTB4M	CSTB4M	CSTB4M	CSTB4M	CSTB4M
	Wrench	T-15D	T-15D	T-15D	T-15D	T-15D
	Center	TPMX 280716R-G	TPMX 280716R-G	TPMX 280716R-G	TPMX 280716R-G	TPMX 280716R-G
Pad	Screw	CSTB5	CSTB5	CSTB5	CSTB5	CSTB5
	Wrench	T-20D	T-20D	T-20D	T-20D	T-20D
	Guide pad	PAD-GP18-40-300-DC-SB	PAD-GP18-40-300-DC-SB	PAD-GP18-40-300-DC-SB	PAD-GP18-40-300-DC-SB	PAD-GP18-40-300-DC-SB
	Screw	LS1206S	LS1206S	LS1206S	LS1206S	LS1206S
	Wrench	H3	H3	H3	H3	H3
	Guide pad protector	PAD-P18	PAD-P18	PAD-P18	PAD-P18	PAD-P18
	Screw	LS1206S	LS1206S	LS1206S	LS1206S	LS1206S
	Wrench	H3	H3	H3	H3	H3
	Sub guide pad	PAD-S14	PAD-S14	PAD-S14	PAD-S14	PAD-S14
	Screw	CSTA5S	CSTA5S	CSTA5S	CSTA5S	CSTA5S
	Wrench	T-15D	T-15D	T-15D	T-15D	T-15D



Assembly of TBTA9 series

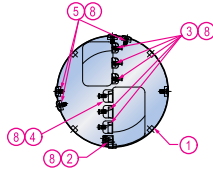
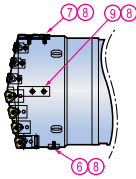

1. Head shank
2. Outer cartridge
3. Inner cartridge
4. Center cartridge
5. Guide pad
6. Sub guide pad
7. Guide pad protector
8. Lock screw
9. Filler

Parts		Diameter (mm)			
		272.00-275.99	276.00-284.99	285.00-289.99	290.00-293.99
Cartridge	Outer	PERC 402-63	PERC 402-63	PERC 402-63	PERC 402-63
	Adjust screw	AS0006-15	AS0006-15	AS0006-15	AS0006-15
	Wrench	H3	H3	H3	H3
	Screw	L1806RH	L1806RH	L1806RH	L1806RH
	Wrench	H4	H4	H4	H4
	Inner	CENC 402-63	CENC 402-63	CENC 402-63	CENC 402-63
	Screw	LS1206S	LS1206S	LS1206S	LS1206S
	Wrench	H3L	H3L	H3L	H3L
	Center	CENC 402-63	CENC 402-63	CENC 402-63	CENC 402-63
	Screw	LS1206S	LS1206S	LS1206S	LS1206S
Insert	Outer	TPMX 280716R-G	TPMX 280716R-G	TPMX 280716R-G	TPMX 280716R-G
	Screw	CSTB5	CSTB5	CSTB5	CSTB5
	Wrench	T-20D	T-20D	T-20D	T-20D
	Inner	TPMX 280716R-G	TPMX 280716R-G	TPMX 280716R-G	TPMX 280716R-G
	Screw	CSTB5	CSTB5	CSTB5	CSTB5
	Wrench	T-20D	T-20D	T-20D	T-20D
	Center	TPMX 280716R-G	TPMX 280716R-G	TPMX 280716R-G	TPMX 280716R-G
Pad	Screw	CSTB5	CSTB5	CSTB5	CSTB5
	Wrench	T-20D	T-20D	T-20D	T-20D
	Guide pad	PAD-GP18-40-300-DC-SB	PAD-GP18-40-300-DC-SB	PAD-GP18-40-300-DC-SB	PAD-GP18-40-300-DC-SB
	Screw	PAD-GP18-40-300-DC-SC	PAD-GP18-40-300-DC-SC	PAD-GP18-40-300-DC-SC	PAD-GP18-40-300-DC-SC
	Screw	LS1206S	LS1206S	LS1206S	LS1206S
	Wrench	H3	H3	H3	H3
	Guide pad protector	PAD-P18	PAD-P18	PAD-P18	PAD-P18
	Screw	LS1206S	LS1206S	LS1206S	LS1206S
	Wrench	H3	H3	H3	H3
	Sub guide pad	PAD-S14	PAD-S14	PAD-S14	PAD-S14
Screw	CSTA5S	CSTA5S	CSTA5S	CSTA5S	
Wrench	T-15D	T-15D	T-15D	T-15D	



Assembly of TBTA-FB series

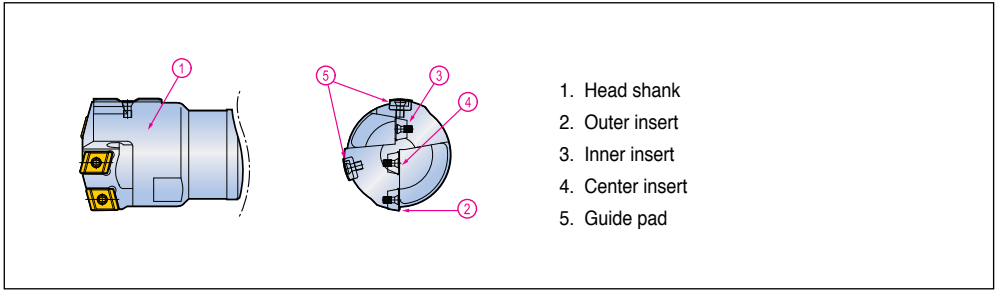

1. Head shank
2. Outer insert
3. Inner insert
4. Center insert
5. Guide pad

Parts		Diameter (mm)			
		25.00-28.00	28.01-29.99	30.00-35.00	35.01-38.00
Insert	PER	NPHT 060304R-G-P	NPHT 060304R-G-P	NPHT 080404R-G-P	NPHT 080404R-G-P
	Screw	CSTB2.2	CSTB2.2	SR 14-560-HG	SR 14-560-HG
	Wrench	T-7F	T-7F	T-8F	T-8F
	INT	NPMT 060304R-G-I	NPMT 060304R-G-I	NPMT 070404R-G-I	NPMT 070404R-G-I
	Screw	CSTB2.2	CSTB2.2	SR 14-560-HG	SR 14-560-HG
	Wrench	T-7F	T-7F	T-8F	T-8F
	CEN	NPMT 060308L-G-C	NPMT 070408L-G-C	NPMT 070408L-G-C	NPMT 080480L-G-C
	Screw	CSTB2.2	SR 14-560-HG	SR 14-560-HG	SR 14-560-HG
	Wrench	T-7F	T-8F	T-8F	T-8F
Pad	PAD	PAD-GP06-20-120-DC-SB	PAD-GP06-20-120-DC-SB	PAD-GP07-20-120-DC-SB	PAD-GP07-20-120-DC-SB
		PAD-GP06-20-120-DC-SC	PAD-GP06-20-120-DC-SC	PAD-GP07-20-120-DC-SC	PAD-GP07-20-120-DC-SC
	Screw	CSTB2.2S	CSTB2.2S	CSTB3S	CSTB3S
	Wrench	T-7F	T-7F	T-9F	T-9F

Parts		Diameter (mm)			
		38.01-39.00	39.01-41.00	41.01-44.00	44.01-45.00
Insert	PER	NPHT 090404R-G-P	NPHT 090404R-G-P	NPHT 090404R-G-P	NPHT 090404R-G-P
	Screw	SR 14-560-HG	SR 14-560-HG	SR 14-560-HG	SR 14-560-HG
	Wrench	T-8F	T-8F	T-8F	T-8F
	INT	NPMT 070404R-G-I	NPMT 070404R-G-I	NPMT 080404R-G-I	NPMT 080404R-G-I
	Screw	SR 14-560-HG	SR 14-560-HG	SR 14-560-HG	SR 14-560-HG
	Wrench	T-8F	T-8F	T-8F	T-8F
	CEN	NPMT 100408L-G-C	NPMT 100408L-G-C	NPMT 100408L-G-C	NPMT 100408L-G-C
	Screw	SR 14-560-HG	SR 14-560-HG	SR 14-560-HG	SR 14-560-HG
	Wrench	T-8F	T-8F	T-8F	T-8F
Pad	PAD	PAD-GP07-20-120-DC-SB	PAD-GP08-25-155-DC-SB	PAD-GP08-25-155-DC-SB	PAD-GP08-25-155-DC-SB
		PAD-GP07-20-120-DC-SC	PAD-GP08-25-155-DC-SC	PAD-GP08-25-155-DC-SC	PAD-GP08-25-155-DC-SC
	Screw	CSTB3S	CSTB3S	CSTB3S	CSTB3S
	Wrench	T-9F	T-9F	T-9F	T-9F

• Insert and guide pad are sold separately from drill body.



TBTA-FB Series



Assembly of TBTA-FB series

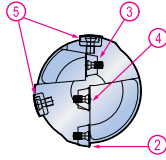
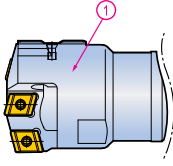

1. Head shank
2. Outer insert
3. Inner insert
4. Center insert
5. Guide pad

Parts		Diameter (mm)			
		45.01-47.00	47.01-51.00	51.01-54.00	54.01-57.00
Insert	PER	NPHT 090404R-G-P	NPHT 110404R-G-P	NPHT 110404R-G-P	NPHT 110404R-G-P
	Screw	SR 14-560-HG	SR 14-560-HG	SR 14-560-HG	SR 14-560-HG
	Wrench	T-8F	T-8F	T-8F	T-8F
	INT	NPMT 080404R-G-I	NPMT 080404R-G-I	NPMT 100404R-G-I	NPMT 100404R-G-I
	Screw	SR 14-560-HG	SR 14-560-HG	SR 14-560-HG	SR 14-560-HG
	Wrench	T-8F	T-8F	T-8F	T-8F
	CEN	NPMT 100408L-G-C	NPMT 100408L-G-C	NPMT 100408L-G-C	NPMT 130408L-G-C
	Screw	SR 14-560-HG	SR 14-560-HG	SR 14-560-HG	SR 14-560-HG
Pad	Wrench	T-8F	T-8F	T-8F	T-8F
	PAD	PAD-GP10-30-200-DC-SB	PAD-GP10-30-200-DC-SB	PAD-GP10-30-200-DC-SB	PAD-GP10-30-200-DC-SB
		PAD-GP10-30-200-DC-SC	PAD-GP10-30-200-DC-SC	PAD-GP10-30-200-DC-SC	PAD-GP10-30-200-DC-SC
	Screw	CSTB3.5	CSTB3.5	CSTB3.5	CSTB3.5
Wrench	T-15F	T-15F	T-15F	T-15F	

Parts		Diameter (mm)		
		57.01-60.00	60.01-64.00	64.01-65.00
Insert	PER	NPHT 110404R-G-P	NPHT 130404R-G-P	NPHT 130404R-G-P
	Screw	SR 14-560-HG	SR 14-560-HG	SR 14-560-HG
	Wrench	T-8F	T-8F	T-8F
	INT	NPMT 100404R-G-I	NPMT 100404R-G-I	NPMT 130404R-G-I
	Screw	SR 14-560-HG	SR 14-560-HG	SR 14-560-HG
	Wrench	T-8F	T-8F	T-8F
	CEN	NPMT 130408L-G-C	NPMT 130408L-G-C	NPMT 130408L-G-C
	Screw	SR 14-560-HG	SR 14-560-HG	SR 14-560-HG
Pad	Wrench	T-8F	T-8F	T-8F
	PAD	PAD-GP12-35-250-DC-SB	PAD-GP12-35-250-DC-SB	PAD-GP12-35-250-DC-SB
		PAD-GP12-35-250-DC-SC	PAD-GP12-35-250-DC-SC	PAD-GP12-35-250-DC-SC
	Screw	CSTB3.5	CSTB3.5	CSTB3.5
Wrench	T-15F	T-15F	T-15F	



• Insert and guide pad are sold separately from drill body.

TBTA-R...S11



Single tube system

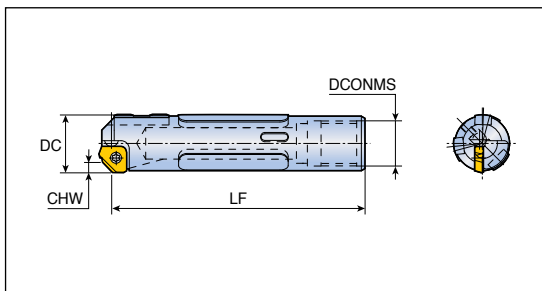

- Inner single start thread

Designation	DC	CHW (mm)	Dimension (mm)		Tube	
			LF	DCONMS	Part	Diameter (mm)
TBTA-R- xxx.xxS11-22	25.00-26.99	2.8	110.5	20	BTSE 022	22
xxx.xxS11-24	27.00-29.99	2.8	110.5	22	BTSE 024	24
xxx.xxS11-26	30.00-31.99	2.8	110.5	24	BTSE 026	26
xxx.xxS11-28	32.00-33.99	2.8	110.5	26	BTSE 028	28
xxx.xxS11-30	34.00-36.99	2.8	135.5	27	BTSE 030	30
xxx.xxS11-33	37.00-39.99	2.8	135.5	30	BTSE 033	33

TBTA-R...S11



Single tube system

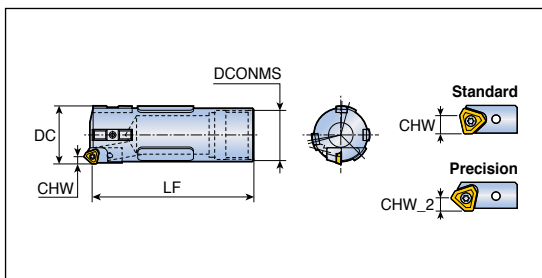

- Inner single start thread

Designation	DC	CHW (mm)		Dimension (mm)		Tube	
		Standard	Precision	LF	DCONMS	Part	Diameter (mm)
TBTA-R- xxx.xxS11-36	40.00-43.99	6.4	4	135	33	BTSE 036	36
xxx.xxS11-39	44.00-46.99	6.4	4	135	37	BTSE 039	39
xxx.xxS11-43	47.00-51.99	6.4	4	145	41	BTSE 043	43
xxx.xxS11-47	52.00-56.99	7.2	4.8	145	44	BTSE 047	47
xxx.xxS11-51	57.00-60.99	7.2	4.8	170	49	BTSE 051	51
xxx.xxS11-56	61.00-67.99	7.2/10.4	4.8/6.4	170	53	BTSE 056	56
xxx.xxS11-62	68.00-74.99	10.4	6.4	170	59	BTSE 062	62
xxx.xxS11-68	75.00-80.99	10.4	6.4	205	65	BTSE 068	68
xxx.xxS11-75	81.00-90.99	10.4	6.4	215	71	BTSE 075	75
xxx.xxS11-82	91.00-98.99	10.4	6.4	225	79	BTSE 082	82
xxx.xxS11-94	99.00-110.99	10.4	6.4	235	90	BTSE 094	94

 Assembly D124	 Tube D135	 Cutting Condition D216
----------------------	------------------	-------------------------------

Assembly of TBTA-R series

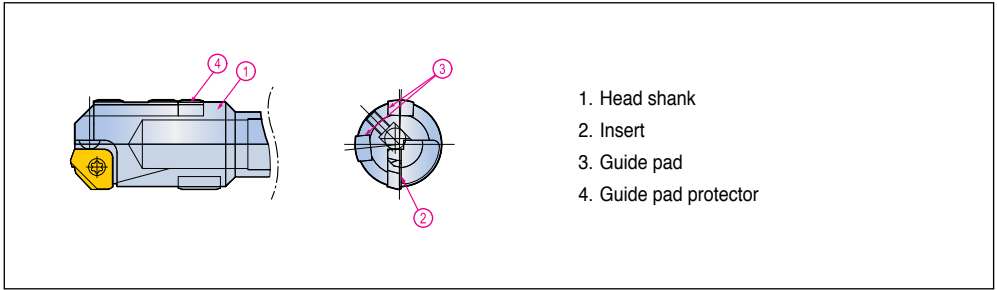

1. Head shank
2. Insert
3. Guide pad
4. Guide pad protector

Parts		Diameter (mm)				
		25.00-27.99	28.00-29.99	30.00-37.99	38.00-39.99	
Close tolerance	Cartridge	Adjust ball	BALL5	BALL5	BALL5	BALL5
		Adjust screw	AS0005-5	AS0005-5	AS0005-5	AS0005-5
		Wrench	H2.5	H2.5	H2.5	H2.5
	Insert	Screw	-	-	-	-
		Wrench	-	-	-	-
		Insert	XPMT 16002-45	XPMT 16002-45	XPMT 16002-45	XPMT 16002-45
		Screw	CSTANO3	CSTANO3	CSTANO3	CSTANO3
Wrench	T-9D	T-9D	T-9D	T-9D		
Normal tolerance	Cartridge	Outer	-	-	-	-
		Adjust screw	-	-	-	-
		Wrench	-	-	-	-
		Screw	-	-	-	-
		Wrench	-	-	-	-
	Insert	Insert	XPMT 16002-45	XPMT 16002-45	XPMT 16002-45	XPMT 16002-45
		Screw	CSTANO3	CSTANO3	CSTANO3	CSTANO3
		Wrench	T-9D	T-9D	T-9D	T-9D
		Outer	-	-	-	-
Pad	Guide pad (A)	PAD-GP06-20-120-DC-SB	PAD-GP06-20-120-DC-SB	PAD-GP07-20-120-DC-SB	PAD-GP08-25-155-DC-SB	
		PAD-GP06-20-120-DC-SC	PAD-GP06-20-120-DC-SC	PAD-GP07-20-120-DC-SC	PAD-GP08-25-155-DC-SC	
	Screw	CSTB2.2S	CSTB2.2S	CSTB3S	CSTB3S	
	Wrench	T-9D	T-9D	T-9D	T-9D	
	Guide pad protector (B)	-	-	-	PAD-P08	
		-	-	-	CSTB3S	
	Wrench	-	-	-	T-9D	
	Resin guide pad (C)	PAD-R10	PAD-R10	PAD-R12	PAD-R15	
		Screw	LS0902, 5-6	LS0902, 5-6	LS0903-8	LS0904-10
	Wrench	-	-	H2	H2.5	



- A + B is for outer four start thread connection type
- A + C is for inner single start thread connection type

TBTA-R Series



Assembly of TBTA-R series

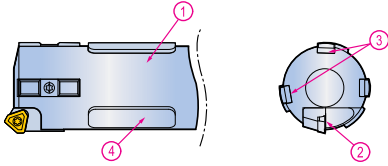

1. Head shank
2. Cartridge & lock screw
3. Guide pad
4. Resin guide pad & lock screw

Parts		Diameter (mm)				
		40.00-45.99	46.00-51.99	52.00-56.99	57.00-59.99	
Close tolerance	Cartridge	Outer	PERC-P 04R	PERC-P 04R	PERC-P 32R	PERC-P 32R
		Adjust screw	AS0004-8	AS0004-8	AS0005-10	AS0005-10
		Wrench	H2	H2	H2.5	H2.5
	Insert	Screw	LS1803.5RH	LS1803.5RH	LS1805RH	LS1805RH
		Wrench	H2.5	H2.5	H3	H3
		Wrench	T-8D	T-8D	T-8D	T-8D
Normal tolerance	Cartridge	Outer	PERC 402-04	PERC 402-04	PERC 402-32	PERC 402-32
		Adjust screw	AS0004-8	AS0004-8	AS0005-10	AS0005-10
		Wrench	H2	H2	H2.5	H2.5
	Insert	Screw	LS1803.5RH	LS1803.5RH	LS1805RH	LS1805RH
		Wrench	H2.5	H2.5	H3	H3
		Wrench	T-8D	T-8D	T-8D	T-8D
Pad	Guide pad (A)	PAD-GP08-25-155-DC-SB	PAD-GP10-30-200-DC-SB	PAD-GP10-30-200-DC-SB	PAD-GP14-40-250-DC-SB	
		PAD-GP08-25-155-DC-SC	PAD-GP10-30-200-DC-SC	PAD-GP10-30-200-DC-SC	PAD-GP14-40-250-DC-SC	
	Screw	CSTB3S	CSTB3.5	CSTB3.5	CSTA5S	
	Wrench	T-9D	T-15D	T-15D	T-15D	
	Guide pad protector (B)	PAD-P08	PAD-P10	PAD-P10	PAD-P14	
		Screw	CSTB3S	CSTB4S	CSTB4S	CSTA5S
	Wrench	T-9D	T-15D	T-15D	T-15D	
	Resin guide pad (C)	PAD-R15	PAD-R15	PAD-R15	PAD-R20	
		Screw	LS0904-10	LS0904-10	LS0904-10	LS0905-12
	Wrench	H2.5	H2.5	H2.5	H3	



- A + B is for outer four start thread connection type
- A + C is for inner single start thread connection type

Assembly of TBTA-R series

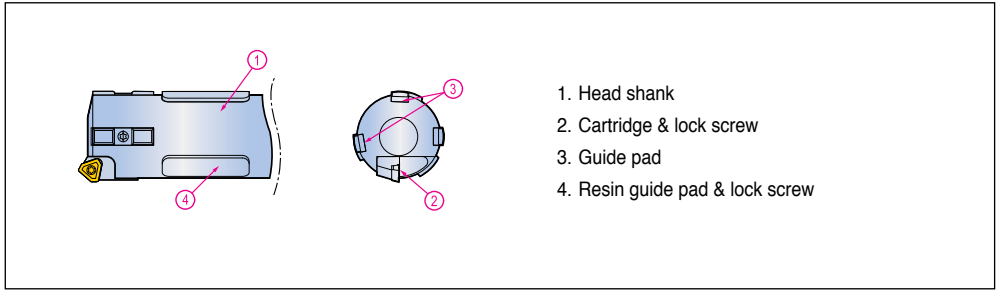

1. Head shank
2. Cartridge & lock screw
3. Guide pad
4. Resin guide pad & lock screw

Parts		Diameter (mm)				
		60.00-80.99	81.00-90.99	91.00-99.99	100.00-122.99	
Close tolerance	Cartridge	Outer	PERC-P 43R	PERC-P 43R	PERC-P 43R	PERC-P 43R
		Adjust screw	AS0005-15	AS0005-15	AS0005-15	AS0005-15
		Wrench	H2.5	H2.5	H2.5	H2.5
		Screw	LS1806RH	LS1806RH	LS1806RH	LS1806RH
	Insert	Wrench	H4	H4	H4	H4
		Insert	TPMX 2405LG	TPMX 2405LG	TPMX 2405LG	TPMX 2405LG
		Screw	CSTB4M	CSTB4M	CSTB4M	CSTB4M
Normal tolerance	Cartridge	Wrench	T-15D	T-15D	T-15D	T-15D
		Outer	PERC 402-43	PERC 402-43	PERC 402-43	PERC 402-43
		Adjust screw	AS0005-15	AS0005-15	AS0005-15	AS0005-15
		Wrench	H2.5	H2.5	H2.5	H2.5
	Insert	Screw	LS1806RH	LS1806RH	LS1806RH	LS1806RH
		Wrench	H4	H4	H4	H4
		Insert	TPMX 240512R-G	TPMX 170408R-G	TPMX 170408R-G	TPMX 170408R-G
		Screw	CSTB4M	CSTB4M	CSTB4M	CSTB4M
		Wrench	T-15D	T-15D	T-15D	T-15D
		Wrench	T-15D	T-15D	T-15D	T-15D
Pad	Guide pad (A)	PAD-GP14-40-250-DC-SB	PAD-GP14-40-250-DC-SB	PAD-GP14-40-250-DC-SB	PAD-GP18-40-300-DC-SB	
		PAD-GP14-40-250-DC-SC	PAD-GP14-40-250-DC-SC	PAD-GP14-40-250-DC-SC	PAD-GP18-40-300-DC-SC	
	Screw	CSTA5S	CSTA5S	CSTA5S	LS1206S	
	Wrench	T-15D	T-15D	T-15D	H3	
	Guide pad protector (B)	PAD-P14	PAD-P14	PAD-P14	PAD-P18	
		Screw	CSTA5S	CSTA5S	CSTA5S	LS1206S
	Wrench	T-15D	T-15D	T-15D	H3	
	Resin guide pad (C)	PAD-R20	PAD-R30	PAD-R35	PAD-R35	
		Screw	LS0905-12	LS0906-15	LS0906-15	LS0906-15
	Wrench	H3	H4	H4	H4	



- A + B is for outer four start thread connection type
- A + C is for inner single start thread connection type

Assembly of TBTA-TR series

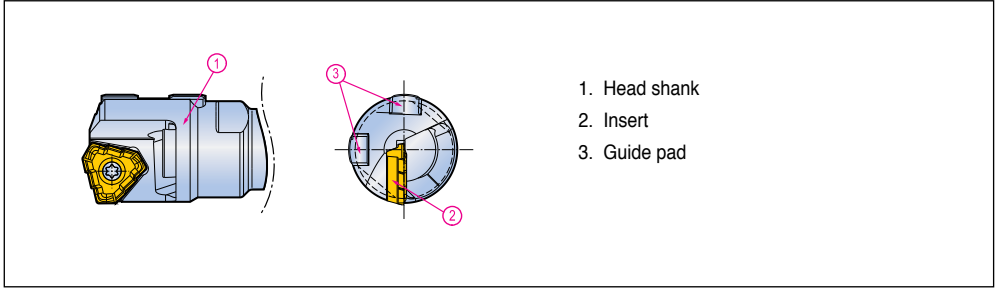

1. Head shank
2. Insert
3. Guide pad

Parts		Diameter (mm)		
		16.00-18.00	18.01-20.00	20.01-21.00
Insert	Insert	TOGT 080305 RS	TOGT 090305 RS	TOGT 100305 RS
	Screw	CSTB2.5S	CSTB2.5S*	CSTB3S*
	Wrench	T-8F	T-8F	T-9F
Guide Pad	Guide Pad	PAD-GP06-20-075-DC-SB	PAD-GP06-20-085-DC-SB	PAD-GP06-20-085-DC-SB
		PAD-GP06-20-075-DC-SC	PAD-GP06-20-085-DC-SC	PAD-GP06-20-085-DC-SC
	Screw	CSTB2.2	CSTB2.2S*	CSTB2.2S*
	Wrench	T-7F	T-7F	T-7F

Parts		Diameter (mm)		
		21.01-21.99	22.00-25.00	25.01-28.00
Insert	Insert	TOGT 100305 RS	TOGT 110405 RS	TOGT 120405 RS
	Screw	CSTB3S*	CSTB3.5H*	CSTB4S*
	Wrench	T-9F	T-15F	T-15F
Guide Pad	Guide Pad	PAD-GP06-20-100-DC-SB	PAD-GP06-20-100-DC-SB	PAD-GP06-20-120-DC-SB
		PAD-GP06-20-100-DC-SC	PAD-GP06-20-100-DC-SC	PAD-GP06-20-120-DC-SC
	Screw	CSTB2.2S*	CSTB2.2S*	CSTB2.2S*
	Wrench	T-7F	T-7F	T-7F

Parts		Diameter (mm)			
		28.01-29.99	30.00-32.00	32.01-39.00	39.01-40.00
Insert	Insert	TOGT 130408 RS	TOGT 130408 RS	TOGT 140510 RS	TOGT 140510 RS
	Screw	SR 16-212/L10	SR 16-212/L10	SR 16-212/L10	SR 16-212/L10
	Wrench	T-20/5	T-20/5	T-20/5	T-20/5
Guide Pad	Guide Pad	PAD-GP06-20-120-DC-SB	PAD-GP07-20-120-DC-SB	PAD-GP07-20-120-DC-SB	PAD-GP08-25-155-DC-SB
		PAD-GP06-20-120-DC-SC	PAD-GP07-20-120-DC-SC	PAD-GP07-20-120-DC-SC	PAD-GP08-25-155-DC-SC
	Screw	CSTB2.2	CSTB3S	CSTB3S	CSTB3S
	Wrench	T-7F	T-9F	T-9F	T-9F

• Insert and guide pad are sold separately from drill body.



BTA...SE2/SE4



Single tube system

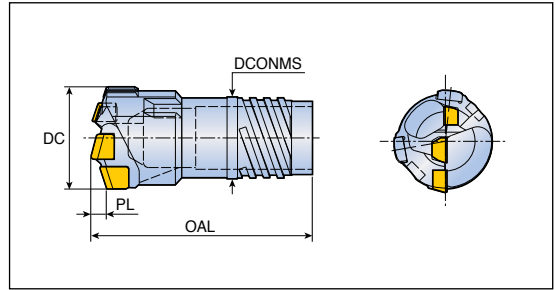

- Outer four start thread

Designation	DC	Dimension (mm)			Tube	
		OAL	PL	DCONMS	Part	Diameter (mm)
BTA xxx.xx SE2-11*	12.60-13.10	43.0	1.1	9.6	BTSI011	11
xxx.xx SE2-11*	13.11-13.60	43.0	1.1	9.6	BTSI011	11
xxx.xx SE2-12*	13.61-14.10	43.0	1.2	10.6	BTSI012	12
xxx.xx SE2-12*	14.11-14.60	43.0	1.2	10.6	BTSI012	12
xxx.xx SE2-13*	14.61-15.10	43.0	1.3	11.6	BTSI013	13
xxx.xx SE2-13*	15.11-15.59	43.0	1.3	11.6	BTSI013	13
xxx.xx SE4-14	15.60-16.20	43.0	2.7	12.6	BTSI014	14
xxx.xx SE4-14	16.21-16.70	43.0	2.7	12.6	BTSI014	14
xxx.xx SE4-15	16.71-17.20	43.0	2.7	13.6	BTSI015	15
xxx.xx SE4-15	17.21-17.70	43.0	2.7	13.6	BTSI015	15
xxx.xx SE4-16	17.71-18.40	47.0	2.8	14.5	BTSI016	16
xxx.xx SE4-16	18.41-18.90	47.0	2.9	14.5	BTSI016	16
xxx.xx SE4-17	18.91-19.20	47.0	2.9	15.5	BTSI017	17
xxx.xx SE4-17	19.21-20.00	47.0	2.9	15.5	BTSI017	17
xxx.xx SE4-18	20.01-20.90	52.5	3.2	16.0	BTSI018	18
xxx.xx SE4-18	20.91-21.80	52.5	3.2	16.0	BTSI018	18
xxx.xx SE4-20	21.81-22.90	56.0	3.2	18.0	BTSI020	20
xxx.xx SE4-20	22.91-24.10	56.0	3.2	18.0	BTSI020	20
xxx.xx SE4-22	24.11-25.20	57.5	3.5	19.5	BTSI022	22
xxx.xx SE4-22	25.21-26.40	57.5	3.5	19.5	BTSI022	22
xxx.xx SE4-24	26.41-27.50	57.5	3.7	21.0	BTSI024	24
xxx.xx SE4-24	27.51-28.70	57.5	3.7	21.0	BTSI024	24
xxx.xx SE4-26	28.71-29.80	63.5	4.0	23.5	BTSI026	26
xxx.xx SE4-26	29.81-31.00	63.5	4.0	23.5	BTSI026	26
xxx.xx SE4-28	31.01-32.10	63.5	4.3	25.5	BTSI028	28
xxx.xx SE4-28	32.11-33.30	63.5	4.3	25.5	BTSI028	28
xxx.xx SE4-30	33.31-34.80	63.5	4.5	28.0	BTSI030	30
xxx.xx SE4-30	34.81-36.20	63.5	4.5	28.0	BTSI030	30
xxx.xx SE4-33	36.21-37.30	73.5	4.8	30.0	BTSI033	33
xxx.xx SE4-33	37.31-38.40	73.5	4.8	30.0	BTSI033	33
xxx.xx SE4-33	38.41-39.60	73.5	4.8	30.0	BTSI033	33
xxx.xx SE4-36	39.61-40.60	73.5	5.6	33.0	BTSI036	36
xxx.xx SE4-36	40.61-41.80	73.5	5.6	33.0	BTSI036	36
xxx.xx SE4-36	41.81-43.00	73.5	5.6	33.0	BTSI036	36
xxx.xx SE4-39	43.01-44.30	75.0	5.4	36.0	BTSI039	39

- *1' 2 cutting edge head, 2 start thread

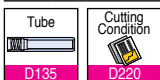

Double tube system

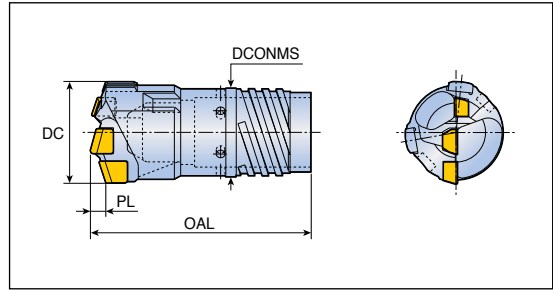

- Outer four start thread

Designation	DC	Dimension (mm)			Tube		
		OAL	PL	DCONMS	Outer tube	Inner tube	Diameter (mm)
BTA xxx.xx DE4-18	18.41-19.20	50.0	2.9	16.0	BTDO018	BTDI012	18.0
xxx.xx DE4-18	19.21-20.00	50.0	2.9	16.0	BTDO018	BTDI012	18.0
xxx.xx DE4-19.5	20.01-20.90	56.0	3.2	18.0	BTDO019.5	BTDI014	19.5
xxx.xx DE4-19.5	20.91-21.80	56.0	3.2	18.0	BTDO019.5	BTDI014	19.5
xxx.xx DE4-21.5	21.81-22.90	56.0	3.2	19.5	BTDO021.5	BTDI015	21.5
xxx.xx DE4-21.5	22.91-24.10	56.0	3.2	19.5	BTDO021.5	BTDI015	21.5
xxx.xx DE4-23.5	24.11-25.20	57.5	3.5	21.0	BTDO023.5	BTDI016	23.5
xxx.xx DE4-23.5	25.21-26.40	57.5	3.5	21.0	BTDO023.5	BTDI016	23.5
xxx.xx DE4-26	26.41-27.50	60.5	3.7	23.5	BTDO026	BTDI018	26.0
xxx.xx DE4-26	27.51-28.70	60.5	3.7	23.5	BTDO026	BTDI018	26.0
xxx.xx DE4-28	28.71-29.80	63.5	4.0	25.5	BTDO028	BTDI020	28.0
xxx.xx DE4-28	29.81-31.00	63.5	4.0	25.5	BTDO028	BTDI020	28.0
xxx.xx DE4-30.5	31.01-32.10	63.5	4.1	28.0	BTDO030.5	BTDI022	30.5
xxx.xx DE4-30.5	32.11-33.30	63.5	4.1	28.0	BTDO030.5	BTDI022	30.5
xxx.xx DE4-33	33.31-34.80	70.5	4.5	30.0	BTDO033.0	BTDI024	33.0
xxx.xx DE4-33	34.81-36.20	70.5	4.5	30.0	BTDO033.0	BTDI024	33.0
xxx.xx DE4-35.5	36.21-37.30	73.5	4.8	33.0	BTDO035.5	BTDI026	35.5
xxx.xx DE4-35.5	37.31-38.40	73.5	4.8	33.0	BTDO035.5	BTDI026	35.5
xxx.xx DE4-35.5	38.41-39.60	73.5	4.8	33.0	BTDO035.5	BTDI026	35.5
xxx.xx DE4-39	39.61-40.60	73.5	5.3	36.0	BTDO039	BTDI029	39.0
xxx.xx DE4-39	40.61-41.80	73.5	5.3	36.0	BTDO039	BTDI029	39.0
xxx.xx DE4-39	41.81-43.00	73.5	5.3	36.0	BTDO039	BTDI029	39.0
xxx.xx DE4-42.5	43.01-44.30	75.0	5.5	39.0	BTDO042.5	BTDI032	42.5
xxx.xx DE4-42.5	44.31-45.60	75.0	5.5	39.0	BTDO042.5	BTDI032	42.5
xxx.xx DE4-42.5	45.61-47.00	75.0	5.5	39.0	BTDO042.5	BTDI032	42.5
xxx.xx DE4-46.5	47.01-48.50	79.0	6.1	43.0	BTDO046.5	BTDI035	46.5
xxx.xx DE4-46.5	48.51-50.10	79.0	6.1	43.0	BTDO046.5	BTDI035	46.5
xxx.xx DE4-46.5	50.11-51.70	79.0	6.1	43.0	BTDO046.5	BTDI035	46.5
xxx.xx DE4-51	51.71-53.20	82.0	6.5	47.0	BTDO051	BTDI039	51.0
xxx.xx DE4-51	53.21-54.70	82.0	6.5	47.0	BTDO051	BTDI039	51.0
xxx.xx DE4-51	54.71-56.20	82.0	6.5	47.0	BTDO051	BTDI039	51.0
xxx.xx DE4-55.5	56.21-58.40	84.0	6.6	51.0	BTDO055.5	BTDI043A	55.5
xxx.xx DE4-55.5	58.41-60.60	84.0	6.6	51.0	BTDO055.5	BTDI043A	55.5
xxx.xx DE4-55.5	60.61-62.80	84.0	6.6	51.0	BTDO055.5	BTDI043A	55.5
xxx.xx DE4-55.5	62.81-65.00	84.0	6.6	51.0	BTDO055.5	BTDI043A	55.5

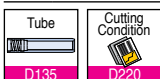

BTS...SE1



Single tube system

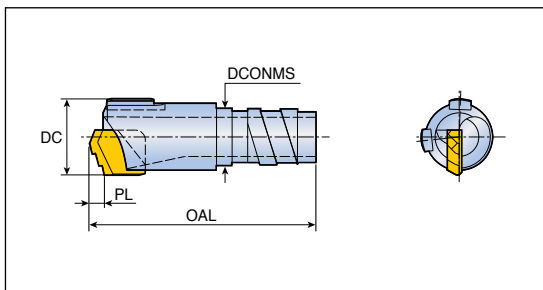

- Outer single start thread

Designation	DC	Dimension (mm)			Tube	
		OAL	PL	DCONMS	Part	Diameter (mm)
BTS xxx.xx SE1-7.1	8.00-8.99	34	2.0	6.0	BTSO071	7.1
xxx.xx SE1-8.3	9.00-9.99	34	2.0	7.2	BTSO083	8.3
xxx.xx SE1-9	10.00-10.99	34	2.2	7.6	BTSO090	9.0
xxx.xx SE1-10	11.00-11.99	34	2.2	8.6	BTSO100	10.0
xxx.xx SE1-11	12.00-13.49	34	2.3	9.1	BTSO110	11.0
xxx.xx SE1-12	13.50-14.79	34	2.4	10.8	BTSO120	12.0

BTS...SE2/SE4



Single tube system

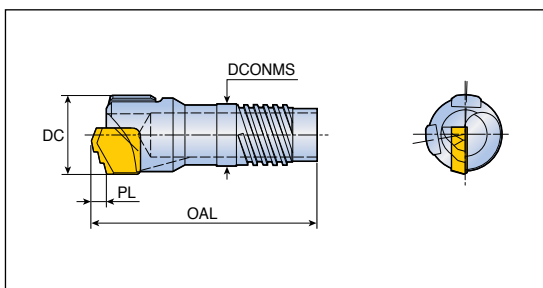

- Outer four start thread

Designation	DC	Dimension (mm)			Tube	
		OAL	PL	DCONMS	Part	Diameter (mm)
BTS xxx.xx SE2-11*	12.60-13.60	40	2.3	9.6	BTSI011	11
xxx.xx SE2-12*	13.61-14.60	40	2.4	10.6	BTSI012	12
xxx.xx SE2-13*	14.61-15.59	40	3.0	11.6	BTSI013	13
xxx.xx SE4-14	15.60-16.70	40	2.4	12.6	BTSI014	14
xxx.xx SE4-15	16.71-17.70	40	3.0	13.6	BTSI015	15
xxx.xx SE4-16	17.71-18.90	40	3.3	14.5	BTSI016	16
xxx.xx SE4-17	18.91-20.00	40	3.3	15.5	BTSI017	17

- '*1' Designates outer two start thread

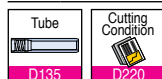

Single tube

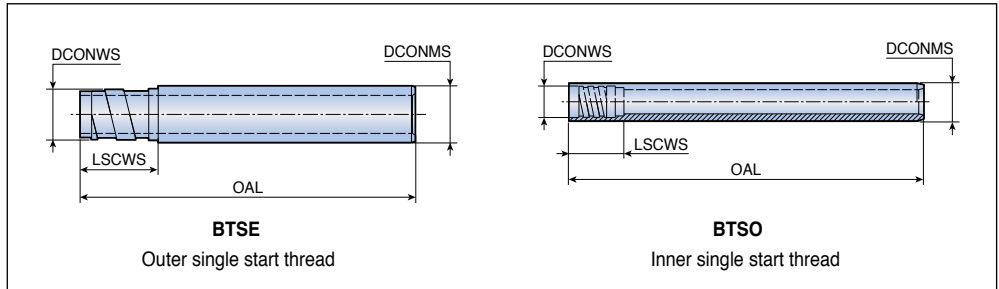

Designation	DC	Dimension (mm)			
		DCONMS	DCONWS	LSCWS	
BTSE 047	52.00-56.99	47.0	44	-	41
051	57.00-60.99	51.0	49	-	41
056	61.00-67.99	56.0	53	-	41
062	68.00-74.99	62.0	59	-	41
068	75.00-80.99	68.0	65	-	71
075	81.00-90.99	75.0	71	-	71
082	91.00-98.99	82.0	79	-	71
094	99.00-110.99	94.0	90	-	71
106	111.00-122.99	106.0	102	-	71
118	123.00-134.99	118.0	114	-	71
130	135.00-148.99	130.0	126	-	71
142	149.00-161.99	142.0	139	-	71
154	162.00-173.99	154.0	151	-	86
166	174.00-185.99	166.0	163	-	86
178	186.00-197.99	178.0	175	-	86
190	198.00-209.99	190.0	187	-	86
202	210.00-221.99	202.0	199	-	86
214	222.00-233.99	214.0	211	-	86
226	234.00-245.99	226.0	223	-	86
238	246.00-257.99	238.0	235	-	86
250	258.00-269.99	250.0	247	-	121
262	270.00-281.99	262.0	259	-	121
274	282.00-293.99	274.0	271	-	121
BTSO 071	8.00-8.99	7.1	-	6.0	13.5
083	9.00-9.99	8.3	-	7.2	13.5
090	10.00-10.99	9.0	-	7.6	13.5
100	11.00-11.99	10.0	-	8.6	13.5
110	12.00-13.49	11.0	-	9.1	13.5
120	13.50-14.79	12.0	-	10.8	13.5

• Please indicate overall length (OAL) when ordering

Double tube

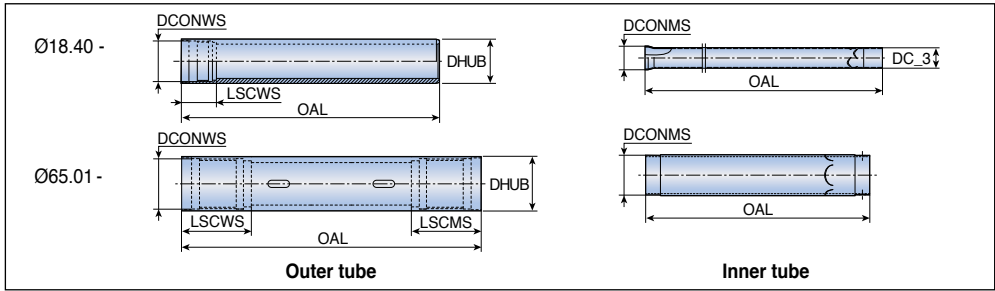

DC	Outer tube	Dimension (mm)			Inner tube	Dimension (mm)	
		DHUB	DCONWS	LSCWS		DCONMS	DC_3
18.40-20.00	BTDO 018	18.0	16	27.5	BTDI 012	12	10
20.01-21.80	019.5	19.5	18	30	014	14	12
21.81-24.10	021.5	21.5	19.5	30	015	15	13
24.11-26.40	023.5	23.5	21	30	016	16	14
26.41-28.70	026	26.0	23.5	33	018	18	16
28.71-31.00	028	28.0	25.5	33	020	20	18
31.01-33.30	030.5	30.5	28	33	022	22	20
33.31-36.20	033	33.0	30	40	024	24	22
36.21-39.60	035.5	35.5	33	40	026	26	24
39.61-43.00	039	39.0	36	40	029	29	27
43.01-47.00	042.5	42.5	39	40	032	32	30
47.01-51.70	046.5	46.5	43	44	035	35	32
51.71-56.20	051	51.0	47	44	039	39	36
56.21-65.00	055.5	55.5	51	44	043A	43	40
65.01-69.99	056	56.0	52	75	043B	40	-
70.00-72.99	062	62.0	58	75	048	44	-
73.00-79.99	068	68.0	63	75	053	48	-
80.00-86.99	075	75.0	70	97	059	54	-
87.00-99.99	082	82.0	77	97	066	60	-
100.00-111.99	094	94.0	89	97	078	70	-
112.00-123.99	106	106.0	101	118	090	80	-
124.00-135.99	118	118.0	113	118	092	80	-
136.00-147.99	130	130.0	125	118	104	95	-
148.00-159.99	142	142.0	137	139	116	100	-
160.00-171.99	154	154.0	149	139	128	120	-
172.00-183.99	166	166.0	161	139	138	130	-

- Please indicate overall length (OAL) when ordering
- For diameter range 18.40 - 65.00 (BTDO 055.5) the inner tube should be ordered 30mm longer than outer tube
- For diameter range 65.01 - 123.99 (BTDO 056 - BTDO 106) the inner tube should be ordered 190mm longer than outer tube
- For diameter range 124.00 - 183.99 (BTDO 118 - BTDO 166) the inner tube should be ordered 220mm longer than outer tube

Assembly of Double Tube System

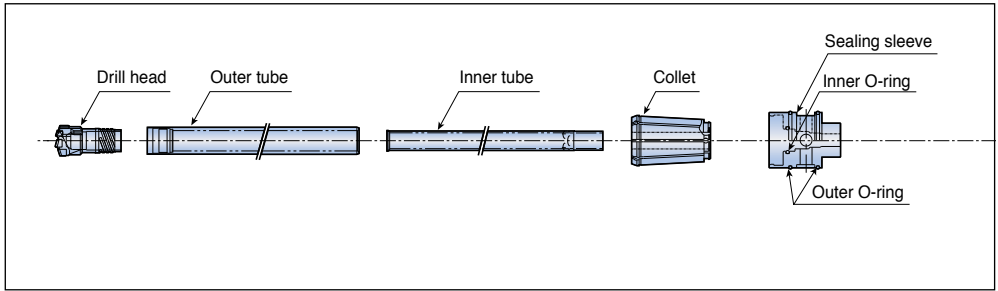

Designation		DC	Collet
BTDO 018	BTDI 012	18.40-19.20	COLLET 4-18
018	012	19.21-20.00	COLLET 4-18
019.5	014	20.01-20.90	COLLET 4-19.5
019.5	014	20.91-21.80	COLLET 4-19.5
021.5	015	21.81-22.90	COLLET 4-21.5
021.5	015	22.91-24.10	COLLET 4-21.5
023.5	016	24.11-25.20	COLLET 4-23.5
023.5	016	25.21-26.40	COLLET 4-23.5
026	018	26.41-27.50	COLLET 4-26
026	018	27.51-28.70	COLLET 4-26
028	020	28.71-29.80	COLLET 4-28
028	020	29.81-31.00	COLLET 4-28
030.5	022	31.01-32.10	COLLET 4-30.5
030.5	022	32.11-33.30	COLLET 4-30.5
033	024	33.31-34.80	COLLET 4-33
033	024	34.81-36.20	COLLET 4-33
035.5	026	36.21-37.30	COLLET 4-35.5
035.5	026	37.31-38.40	COLLET 4-35.5
035.5	026	38.41-39.60	COLLET 4-35.5
039	029	39.61-40.60	COLLET 4-39
039	029	40.61-41.80	COLLET 4-39
039	029	41.81-43.00	COLLET 4-39
042.5	032	43.01-44.30	COLLET 4-42.5
042.5	032	44.31-45.60	COLLET 4-42.5
042.5	032	45.61-47.00	COLLET 4-42.5
046.5	035	47.01-48.50	COLLET 4-46.5
046.5	035	48.51-50.10	COLLET 4-46.5
046.5	035	50.11-51.70	COLLET 4-46.5
051	039	51.71-53.20	COLLET 4-51
051	039	53.21-54.70	COLLET 4-51
051	039	54.71-56.20	COLLET 4-51
055.5	043A	56.21-58.40	COLLET 4-55.5
055.5	043A	58.41-60.60	COLLET 4-55.5
055.5	043A	60.61-62.80	COLLET 4-55.5
055.5	043A	62.81-65.00	COLLET 4-55.5

• Inner tube should be longer than outer tube. Please refer to page D135-D136 for details

Assembly of Double Tube System



Connector

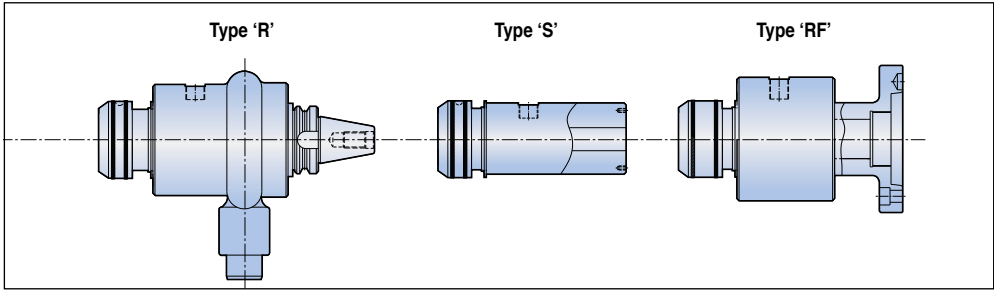

Sealing sleeve	Outer O-ring	Inner O-ring	Connector
SEALING SLEEVE 4R-18	OOR 25.24	IOR18	DTC-4S/4R/4RF
SEALING SLEEVE 4R-18		IOR18	
SEALING SLEEVE 4R-19.5		IOR19.5	
SEALING SLEEVE 4R-19.5		IOR19.5	
SEALING SLEEVE 4R-21.5		IOR21.5	
SEALING SLEEVE 4R-21.5		IOR21.5	
SEALING SLEEVE 4R-23.5		IOR23.5	
SEALING SLEEVE 4R-23.5		IOR23.5	
SEALING SLEEVE 4R-26		IOR26	
SEALING SLEEVE 4R-26		IOR26	
SEALING SLEEVE 4R-28		IOR28	
SEALING SLEEVE 4R-28		IOR28	
SEALING SLEEVE 4R-30.5		IOR30.5	
SEALING SLEEVE 4R-30.5		IOR30.5	
SEALING SLEEVE 4R-33	IOR33		
SEALING SLEEVE 4R-33	IOR33		
SEALING SLEEVE 4R-35.5	OOR65	IOR35.5	
SEALING SLEEVE 4R-35.5		IOR35.5	
SEALING SLEEVE 4R-35.5		IOR35.5	
SEALING SLEEVE 4R-39		IOR39	
SEALING SLEEVE 4R-39		IOR39	
SEALING SLEEVE 4R-39		IOR39	
SEALING SLEEVE 4R-42.5		IOR42.5	
SEALING SLEEVE 4R-42.5		IOR42.5	
SEALING SLEEVE 4R-42.5		IOR42.5	
SEALING SLEEVE 4R-46.5		IOR46.5	
SEALING SLEEVE 4R-46.5		IOR46.5	
SEALING SLEEVE 4R-46.5		IOR46.5	
SEALING SLEEVE 4R-51		IOR51	
SEALING SLEEVE 4R-51		IOR51	
SEALING SLEEVE 4R-51		IOR51	
SEALING SLEEVE 4R-55.5		IOR55.5	
SEALING SLEEVE 4R-55.5	IOR55.5		
SEALING SLEEVE 4R-55.5	IOR55.5		
SEALING SLEEVE 4R-55.5	IOR55.5		

• Inner tube should be longer than outer tube. Please refer to page D135-D136 for details

'S' type connector

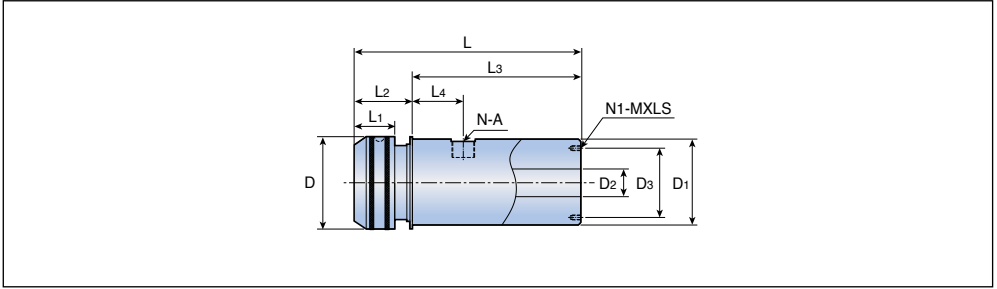

Designation	DC	D	D1	D2	D3	L	L1	L2	L3	L4	N-A	N1-MXLS
DTC 4S	18.4-65.0	115	100	45	80	310	50	60	250	68	2-PT3/4"	4-M8x15
5S	65.0-123.9	164	140	81	120	415	47	115	300		2-PT1"	6-M8x20

DTC-R

'R' type connector

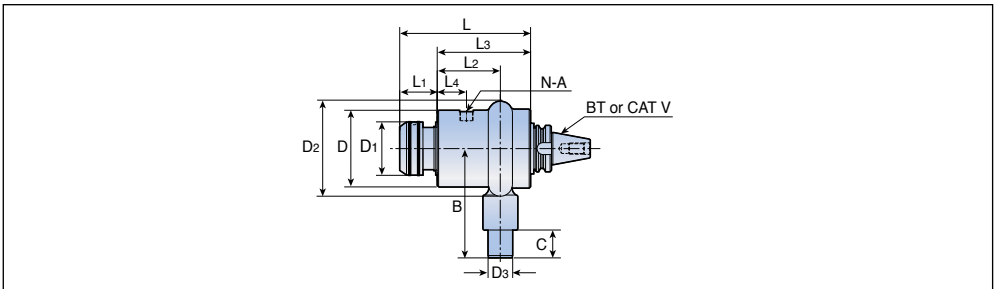

Designation	DC	D	D1	D2	D3	B	C	L	L1	L2	L3	L4	N-A
DTC 4R	18.4-65.0	165	115	206	53	186.5	60	319.7	59.2	152	228	75	2-PT1"
5R	65.0-123.9	225	164	312	100	310	100	382	62	201	320	95	2-PT1 1/4"
6R	124.0-183.9	350	244	445	152.4	412	120	487	75	250	412	118	4-PT1-1/4"

'RF' type connector

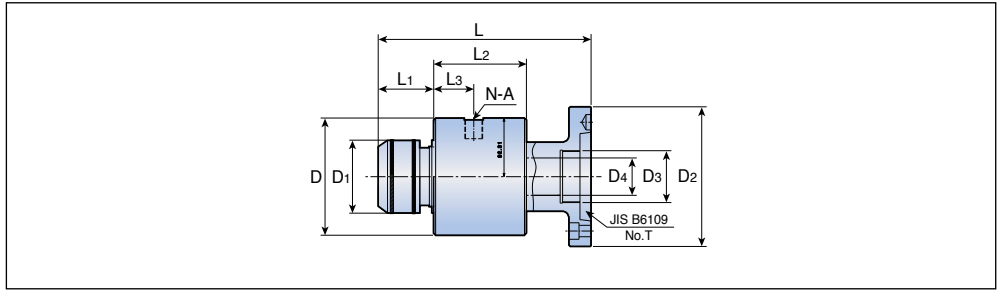

Designation	DC	D	D1	D2	D3	D4	L	L1	L2	L3	N-A
DTC 4RF	18.4-65.0	160	115	210	M62x2	46	291.5	64.5	150	75	2-PT1"

Collet / Sealing Sleeve

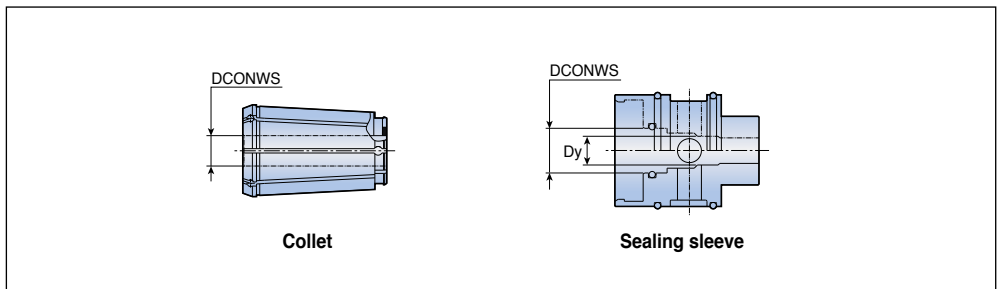

Designation	DC	DCONWS	Designation	DC	DCONWS	Dy	Outer O-ring	Inner O-ring
COLLET 4-18	18.40-20.00	18.0	SEALING SLEEVE 4-18	18.40-20.00	18.0	10	OOR 65	IOR 18
4-19.5	20.01-21.80	19.5	4-19.5	20.01-21.80	19.5	12		IOR 19.5
4-21.5	21.81-24.10	21.5	4-21.5	21.81-24.10	21.5	13		IOR 21.5
4-23.5	24.11-26.40	23.5	4-23.5	24.11-26.40	23.5	14		IOR 23.5
4-26	26.41-28.70	26.0	4-26	26.41-28.70	26.0	16		IOR 26
4-28	28.71-31.00	28.0	4-28	28.71-31.00	28.0	18		IOR 28
4-30.5	31.01-33.30	30.5	4-30.5	31.01-33.30	30.5	20		IOR 30.5
4-33	33.31-36.20	33.0	4-33	33.31-36.20	33.0	22		IOR 33
4-35.5	36.21-39.60	35.5	4-35.5	36.21-39.60	35.5	24		IOR 35.5
4-39	39.61-43.00	39.0	4-39	39.61-43.00	39.0	27		IOR 39
4-42.5	43.01-47.00	42.5	4-42.5	43.01-47.00	42.5	30		IOR 42.5
4-46.5	47.01-51.70	46.5	4-46.5	47.01-51.70	46.5	32		IOR 46.5
4-51	51.71-56.20	51.0	4-51	51.71-56.20	51.0	36		IOR 51
4-55.5	56.21-65.00	55.5	4-55.5	56.21-65.00	55.5	40		IOR 55.5

Standard gundrill holders



- Drilling depth: 10xDC - 25xDC

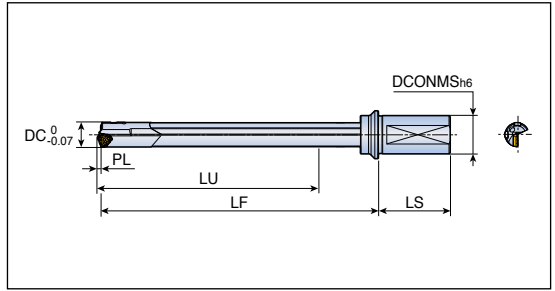

Designation	Dimension (mm)						
	DC	LU	LF	LS	DCONMS	PL	L/D
TRGD 16.00xM25-10	16.0	172	209	56	25	2.2	10
16.50xM25-10	16.5	172	209	56	25	2.2	10
17.00xM25-10	17.0	182	220	56	25	2.2	10
18.00xM25-10	18.0	193	232	56	25	3.0	10
19.00xM25-10	19.0	203	243	56	25	3.0	10
20.00xM32-10	20.0	213	255	60	32	3.2	10
29.00xM40-10	29.0	290	360	69	40	4.57	10
30.00xM40-10	30.0	310	383	69	40	4.57	10
31.00xM40-10	31.0	310	383	69	40	4.57	10
32.00xM40-10	33.0	320	395	69	40	4.57	10
14.00xM25-15	14.0	227	261	56	25	2.0	15
14.50xM25-15	14.5	227	262	56	25	2.0	15
15.00xM25-15	15.0	242	278	56	25	2.0	15
16.00xM25-15	16.0	257	294	56	25	2.2	15
16.50xM25-15	16.5	257	294	56	25	2.2	15
17.00xM25-15	17.0	272	310	56	25	2.2	15
17.50xM25-15	17.5	272	310	56	25	2.2	15
18.00xM25-15	18.0	288	327	56	25	3.0	15
18.50xM25-15	18.5	288	327	56	25	3.0	15
19.00xM25-15	19.0	303	343	56	25	3.0	15
19.50xM25-15	19.5	303	343	56	25	3.0	15
20.00xM32-15	20.0	318	360	60	32	3.2	15
21.00xM32-15	21.0	333	376	60	32	3.2	15
22.00xM32-15	22.0	348	393	60	32	3.4	15
23.00xM32-15	23.0	363	409	60	32	3.4	15
24.00xM32-15	24.0	378	426	60	32	3.4	15
25.00xM32-15	25.0	394	442	60	32	3.6	15
26.00xM40-15	26.0	409	449	70	40	3.6	15
27.00xM40-15	27.0	424	465	70	40	3.6	15
28.00xM40-15	28.0	424	467	70	40	3.6	15
14.00xM25-20	14.0	302	336	56	25	2.0	20
14.50xM25-20	14.5	302	337	56	25	2.0	20
15.00xM25-20	15.0	322	358	56	25	2.0	20
29.00xM40-20	29.0	580	650	69	40	4.57	20
30.00xM40-20	30.0	620	693	69	40	4.57	20

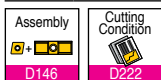

- Guide pad is sold separately from drill body.

- Available upon request

Standard gundrill holders



- Drilling depth: 10xDC - 25xDC

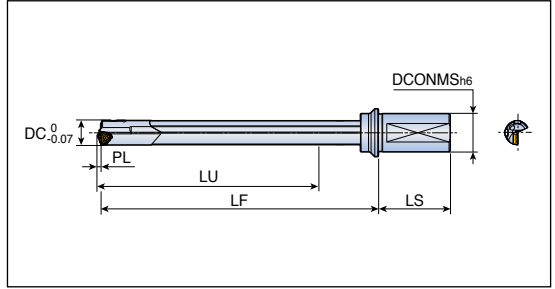

Insert & guide pad

Tool dia. (mm)	Insert			Guide pad		
	Insert	Screw	Wrench	Guide pad	Screw	Wrench
14.00-15.99	TOGT 070304 RS TT9030	CSTB2.5S*	T-8F	PAD-GP05-18-060-DC-SB PAD-GP05-18-060-DC-SC	SR 34-508	T-7F
16.00-18.00	TOGT 080305 RS TT9030	CSTB2.5S*	T-8F	PAD-GP05-18-075-DC-SB PAD-GP05-18-075-DC-SC	SR 34-508	T-7F
18.01-20.00	TOGT 090305 RS TT9030	CSTB2.5S*	T-8F	PAD-GP06-20-085-DC-SB PAD-GP06-20-085-DC-SC	SR 34-508	T-7F
20.01-21.00	TOGT 100305 RS TT9030	CSTB3S*	T-9F			
21.01-21.99	TOGT 100305 RS TT9030	CSTB3S*	T-9F	PAD-GP06-20-100-DC-SB PAD-GP06-20-100-DC-SC	SR 34-508	T-7F
22.00-25.00	TOGT 110405 RS TT9030	SR14-571	T-10/5			
25.01-28.00	TOGT 120405 RS TT9030	CSTB4S*	T-15F	PAD-GP06-20-120-DC-SB PAD-GP06-20-120-DC-SC	SR 34-508	T-7F
28.01-29.99	TOGT 130408 RS	SR 16-212/L10	T-20/5	PAD-GP06-20-120-DC-SB PAD-GP06-20-120-DC-SC	SR 34-508	T-7F
30.00-32.00	TOGT 130408 RS	SR 16-212/L10	T-20/5	PAD-GP07-20-120-DC-SB PAD-GP07-20-120-DC-SC	CSTB-3S	T-9F

- Guide pad with "SB" is the first choice in general purpose machining.
- "SC" is an excellent toughness grade used with water-soluble coolant.
- Inserts and guide pads must be ordered separately



Standard gundrill holders



- Drilling depth: 10xDC - 15xDC

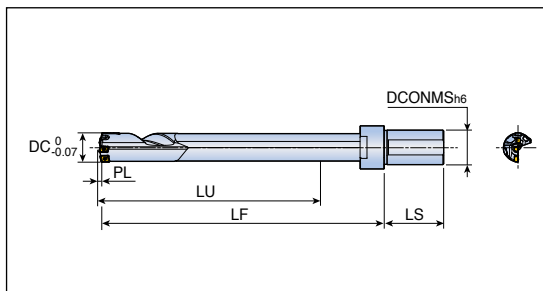

Designation	Dimension (mm)						
	DC	LU	LF	LS	DCONMS	PL	L/D
TRGD3 29.00FM40-10	29.0	293	360	69	40	2.6	10
30.00FM40-10	30.0	313	383	69	40	2.9	10
31.00FM40-10	31.0	313	383	69	40	2.9	10
32.00FM40-10	32.0	323	395	69	40	3.0	10
33.00FM40-10	33.0	333	406	69	40	3.1	10
34.00FM40-10	34.0	343	418	69	40	3.0	10
35.00FM40-10	35.0	353	428	69	40	3.1	10
36.00FM40-10	36.0	363	441	69	40	3.1	10
29.00FM40-15	29.0	438	505	69	40	2.6	15
30.00FM40-15	30.0	468	538	69	40	2.9	15
31.00FM40-15	31.0	468	538	69	40	2.9	15
32.00FM40-15	32.0	483	555	69	40	3.0	15
33.00FM40-15	33.0	498	571	69	40	3.1	15
34.00FM40-15	34.0	513	588	69	40	3.0	15
35.00FM40-15	35.0	528	603	69	40	3.1	15
36.00FM40-15	36.0	543	621	69	40	3.1	15

- Guide pad is sold separately from drill body.
- Supply up to 40.0mm drill diameter

- Available upon request

Insert & guide pad

Parts	Diameter (mm)				
	29.0-29.99	30.0-33.0	33.01-35.0	35.01-36.0	
Insert	Peripheral insert	NPHT 060304R-G-P	NPHT 080404R-G-P	NPHT 080404R-G-P	NPHT 080404R-G-P
	Screw	CSTB2.2	CSTB2.5	CSTB2.5	CSTB2.5
	Wrench	T-7F	T-8F	T-8F	T-8F
	Inner insert	NPMT 060304R-G-I	NPMT 070404R-G-I	NPMT 070404R-G-I	NPMT 070404R-G-I
	Screw	CSTB2.2	CSTB2.5	CSTB2.5	CSTB2.5
	Wrench	T-7F	T-8F	T-8F	T-8F
	Center insert	NPMT 070408L-G-C	NPMT 070408L-G-C	NPMT 070408L-G-C	NPMT 080408L-G-C
	Screw	CSTB2.5	CSTB2.5	CSTB2.5	CSTB2.5
	Wrench	T-8F	T-8F	T-8F	T-8F
Pad	Guide pad	PAD-GP06-20-120-DC-SB PAD-GP06-20-120-DC-SC	PAD-GP06-20-120-DC-SB PAD-GP06-20-120-DC-SC	PAD-GP07-20-120-DC-SB PAD-GP07-20-120-DC-SC	PAD-GP07-20-120-DC-SB PAD-GP07-20-120-DC-SC
	Screw	SR 34-508	SR 34-508	CSTB3S	CSTB3S
	Wrench	T-7F	T-7F	T-9F	T-9F



- Inserts and guide pads must be ordered separately

Standard gundrill holders

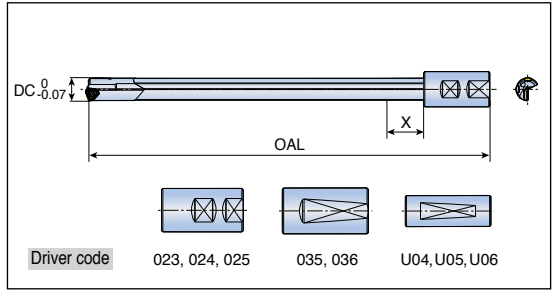

Designation	Driver code	Dimension (mm)		
		DC	OAL	X
TRGDL 14.00X800-XXX	U04 023	14	800	21
14.00X1000-XXX		14	1000	21
14.00X1650-XXX		14	1650	21
14.50X800-XXX		14.5	800	22
14.50X1000-XXX		14.5	1000	22
14.50X1650-XXX		14.5	1650	22
15.00X800-XXX		15	800	23
15.00X1000-XXX		15	1000	23
15.00X1650-XXX		15	1650	23
16.00x800-XXX	U04 023 035	16	800	24
16.00x1000-XXX		16	1000	24
16.00x1500-XXX		16	1500	24
17.00x1000-XXX		17	1000	25
17.00x1500-XXX		17	1500	25
18.00x800-XXX		18	800	27
18.00x1000-XXX		18	1000	27
18.00x1500-XXX		18	1500	27
19.00x800-XXX		19	800	28
19.00x1000-XXX	19	1000	28	
19.00x1500-XXX	19	1500	28	
20.00x800-XXX	U05 024 036	20	800	30
20.00x1000-XXX		20	1000	30
20.00x1500-XXX		20	1500	30
21.00x1000-XXX		21	1000	31
21.00x1500-XXX		21	1500	31
22.00x1000-XXX		22	1000	33
22.00x1500-XXX		22	1500	33
23.00x1000-XXX		23	1000	34
23.00x1500-XXX		23	1500	34
24.00x1000-XXX		24	1000	36
24.00x1500-XXX		24	1500	36
25.00x1000-XXX	25	1000	37	
25.00x1500-XXX	25	1500	37	



• Guide pad is sold separately from drill body.

• Available upon request
• Select "XXX" driver code

Standard gundrill holders

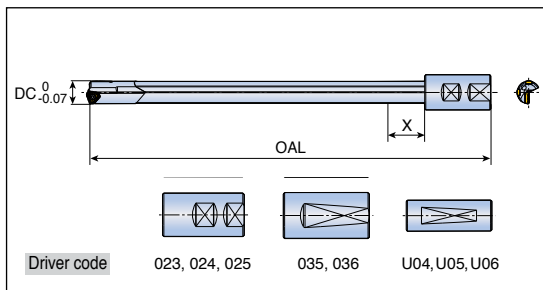

Designation	Driver code	Dimension (mm)		
		DC	OAL	X
TRGDL 26.00x1000-XXX	U06 025 026 036	26	1000	39
26.00x1500-XXX		26	1500	39
27.00x1000-XXX		27	1000	40
27.00x1500-XXX		27	1500	40
28.00x1000-XXX		28	1000	42
28.00x1500-XXX		28	1500	42

• Guide pad is sold separately from drill body.

- Available upon request
- Select "XXX" driver code

Insert & guide pad

Tool dia. (mm)	Insert			Guide pad		
	Insert	Screw	Wrench	Guide pad	Screw	Wrench
14.00-15.99	TOGT 070304 RS TT9030	SR 14-560/S	T-8F	PAD-GP05-18-060-DC-SB PAD-GP05-18-060-DC-SC	SR 34-508	T-7F
16.00-18.00	TOGT 080305 RS TT9030	SR 14-560/S	T-8F	PAD-GP05-18-075-DC-SB PAD-GP05-18-075-DC-SC	SR 34-508	T-7F
18.01-20.00	TOGT 090305 RS TT9030	CSTB2.5S*	T-8F	PAD-GP06-20-085-DC-SB PAD-GP06-20-085-DC-SC	SR 34-508	T-7F
20.01-21.00	TOGT 100305 RS TT9030	CSTB3S*	T-9F			
21.01-21.99	TOGT 100305 RS TT9030	CSTB3S*	T-9F	PAD-GP06-20-100-DC-SB PAD-GP06-20-100-DC-SC	SR 34-508	T-7F
22.00-25.00	TOGT 110405 RS TT9030	CSTB3.5H*	T-15F			
25.01-28.00	TOGT 120405 RS TT9030	CSTB4S*	T-15F	PAD-GP06-20-120-DC-SB PAD-GP06-20-120-DC-SC	SR 34-508	T-7F



- Guide pad with "SB" is the first choice in general purpose machining.
- "SC" is an excellent toughness grade used with water-soluble coolant.
- Inserts and guide pads must be ordered separately

Driver for TRGDL Type



Driver	Tool diameter	Driver code	Dimension (mm)	
			LS	DCONMS
	14.00-19.69	023	56	25.00
	16.00-25.69	024	60	32.00
	16.00-28.00	025	70	40.00
	16.00-28.00	026	80	50.00
	16.00-19.69	035	56	25.00
	16.00-25.69	036	60	32.00
	16.00-19.69	U04	70	25.40
	16.00-25.69	U05	70	31.75
	16.00-28.00	U06	70	38.10

Drilling Heads & Inserts

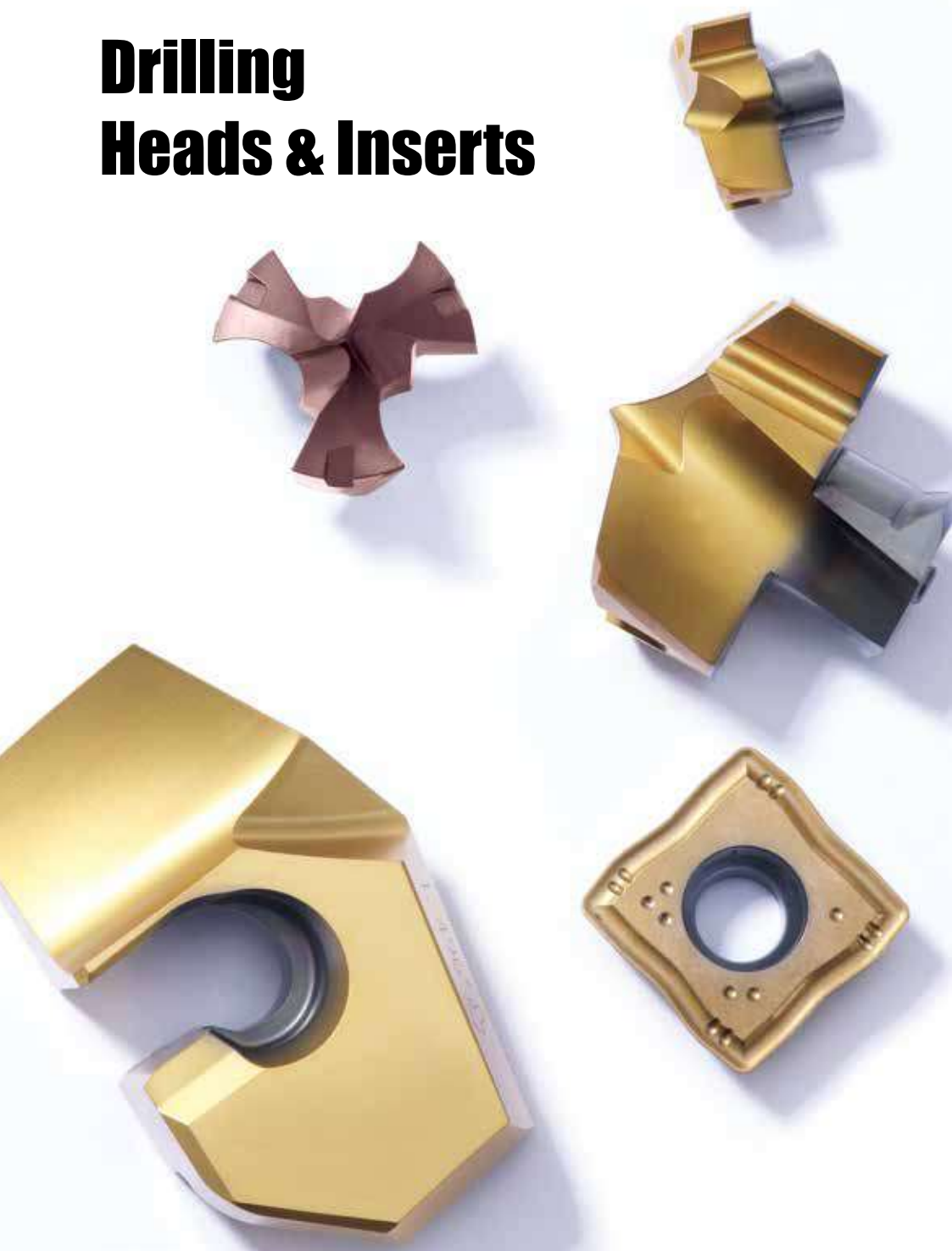

SOMT...DP



Inserts for general purpose

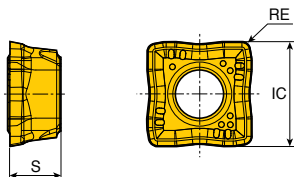

Size	Dimension (mm)		
	IC	S	RE
04	4.4	2.38	0.4
05	4.9	2.38	0.4
06	5.7	2.38	0.4
07	6.8	2.80	0.6
08	7.9	3.97	0.6
09	9.2	3.97	0.8
11	11.0	3.97	0.8
13	12.8	4.40	0.8
15	15.0	4.80	1.0

Insert	Designation	Coated						Uncoated	
		TT9080	TT8020	TT9300	TT9030	TT6030	TT7400	K10	
	SOMT 040204 DP	●	●	●					
	050204 DP	●	●	●					
	060204 DP	●	●	●					
	070306 DP	●	●	●					
	08T306 DP	●	●	●					
	09T308 DP	●	●	●					
	11T308 DP	●	●	●					
	130408 DP	●	●	●					
	150510 DP	●	●	●					



- TT9080: First choice for general purpose
- TT8020: For unstable condition
- TT9300: For high speed machining on a steel application (Peripheral **ONLY**)

●: Standard items

SOMT...DL



Inserts for low carbon steel

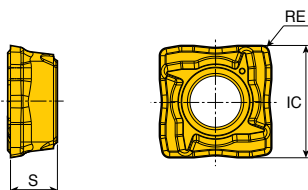

Size	Dimension (mm)		
	IC	S	RE
05	4.9	2.38	0.4
06	5.7	2.38	0.4
07	6.8	2.80	0.6
08	7.9	3.97	0.6
09	9.2	3.97	0.8
11	11.0	3.97	0.8
13	12.8	4.40	0.8
15	15.0	4.80	1.0

Insert	Designation	Coated						Uncoated	
		TT9080	TT9030	TT8020	TT6030	TT9300	TT7400	K10	
	SOMT 050204 DL	●							
	060204 DL	●							
	070306 DL	●							
	08T306 DL	●							
	09T308 DL	●							
	11T308 DL	●							
	130408 DL	●							
	150510 DL	●							



- TT9080: First choice for general purpose

●: Standard items

SOMT...DK



Inserts for cast iron

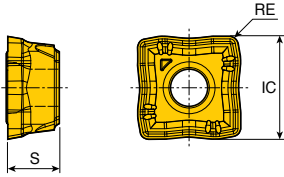

Size	Dimension (mm)		
	IC	S	RE
05	4.9	2.38	0.4
06	5.7	2.38	0.4
07	6.8	2.80	0.6
08	7.9	3.97	0.6
09	9.2	3.97	0.8
11	11.0	3.97	0.8
13	12.8	4.40	0.8
15	15.0	4.80	1.0

Insert	Designation	Coated							Uncoated	
		TT9080	TT8020	TT9300	TT9030	TT6030	TT6080	TT7400	K10	
	SOMT 050204 DK					●				
	060204 DK					●				
	070306 DK					●				
	08T306 DK					●				
	09T308 DK					●				
	11T308 DK					●				
	130408 DK					●				
	150510 DK					●				



●: Standard items

SOMT...DA



Inserts for aluminum alloy

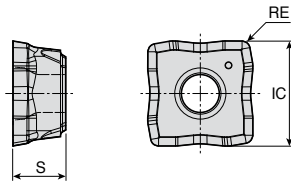

Size	Dimension (mm)		
	IC	S	RE
05	4.9	2.38	0.4
06	5.7	2.38	0.4
07	6.8	2.80	0.6
08	7.9	3.97	0.6
09	9.2	3.97	0.8
11	11.0	3.97	0.8
13	12.8	4.40	0.8
15	15.0	4.80	1.0

Insert	Designation	Coated							Uncoated	
		TT9080	TT8020	TT9300	TT9030	TT6030	TT6080	TT7400	K10	
	SOMT 050204 DA								●	
	060204 DA								●	
	070306 DA								●	
	08T306 DA								●	
	09T308 DA								●	
	11T308 DA								●	
	130408 DA								●	
	150510 DA								●	



●: Standard items

SPMG...DG



Inserts for general purpose

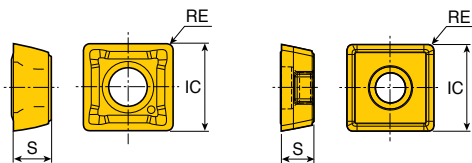

SPMG 120408 DG

Size	Dimension (mm)		
	IC	S	RE
05	5.00	2.38	0.4
06	6.00	2.38	0.4
07	7.94	3.97	0.8
09	9.80	4.30	0.8
11	11.50	4.80	0.8
12	12.70	4.76	0.8
14	14.30	5.20	1.2

Insert	Designation	Coated						Uncoated	
		TT9080	TT9030	TT8020	TT6030	TT9300	TT7400		
	SPMG 050204 DG		●	●		●			
	060204 DG		●	●		●			
	07T308 DG		●	●		●			
	090408 DG		●	●		●			
	110408 DG		●	●		●			
	120408 DG		●						
	140512 DG		●	●		●			



- TT9030: First choice for general purpose
- TT8020: For unstable condition
- TT7400: For high speed machining on a steel application (Peripheral **ONLY**)

●: Standard items

SPMG...DK



Inserts for cast iron

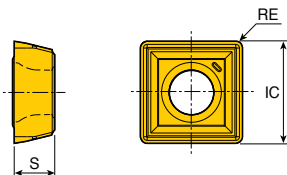

Size	Dimension (mm)		
	IC	S	RE
05	5.00	2.38	0.4
06	6.00	2.38	0.4
07	7.94	3.97	0.8
09	9.80	4.30	0.8
11	11.50	4.80	0.8
14	14.30	5.20	1.2

Insert	Designation	Coated						Uncoated	
		TT9080	TT9030	TT8020	TT6030	TT9300	TT7400		
	SPMG 050204 DK				●				
	060204 DK				●				
	07T308 DK				●				
	090408 DK				●				
	110408 DK				●				
	120408 DK				●				
	140512 DK				●				



●: Standard items

3 flute drill heads

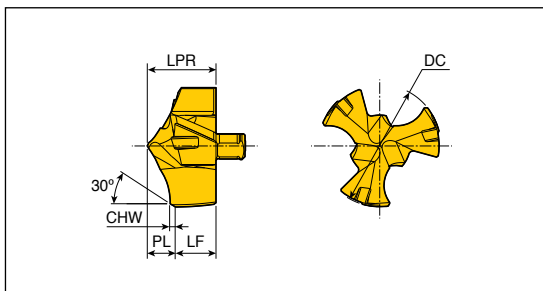

Designation	Dimension (mm)						Grade
	DC	LPR	PL	LF	CHW	SSC	TT5130
3ED-150-P+	15.0	8.40	3.31	5.09	0.50	15	●
151-P+	15.1	8.40	3.31	5.09	0.50	15	●
152-P+	15.2	8.40	3.31	5.09	0.50	15	●
153-P+	15.3	8.40	3.31	5.09	0.50	15	●
154-P+	15.4	8.40	3.31	5.09	0.50	15	●
155-P+	15.5	8.40	3.32	5.08	0.50	15	●
156-P+	15.6	8.40	3.32	5.08	0.50	15	●
157-P+	15.7	8.40	3.32	5.08	0.50	15	●
158-P+	15.8	8.40	3.32	5.08	0.50	15	●
159-P+	15.9	8.40	3.32	5.08	0.50	15	●
160-P+	16.0	9.00	3.70	5.30	0.70	16	●
161-P+	16.1	9.00	3.70	5.30	0.70	16	●
162-P+	16.2	9.00	3.70	5.30	0.70	16	●
163-P+	16.3	9.00	3.70	5.30	0.70	16	●
164-P+	16.4	9.00	3.70	5.30	0.70	16	●
165-P+	16.5	9.00	3.71	5.29	0.70	16	●
166-P+	16.6	9.00	3.71	5.29	0.70	16	●
167-P+	16.7	9.00	3.71	5.29	0.70	16	●
168-P+	16.8	9.00	3.71	5.29	0.70	16	●
169-P+	16.9	9.00	3.71	5.29	0.70	16	●
170-P+	17.0	9.50	3.88	5.62	0.70	17	●
171-P+	17.1	9.50	3.88	5.62	0.70	17	●
172-P+	17.2	9.50	3.88	5.62	0.70	17	●
173-P+	17.3	9.50	3.88	5.62	0.70	17	●
174-P+	17.4	9.50	3.88	5.62	0.70	17	●
175-P+	17.5	9.50	3.89	5.61	0.70	17	●
176-P+	17.6	9.50	3.89	5.61	0.70	17	●
177-P+	17.7	9.50	3.89	5.61	0.70	17	●
178-P+	17.8	9.50	3.89	5.61	0.70	17	●
179-P+	17.9	9.50	3.89	5.61	0.70	17	●



● SSC: Seat size code

●: Standard items

3 flute drill heads

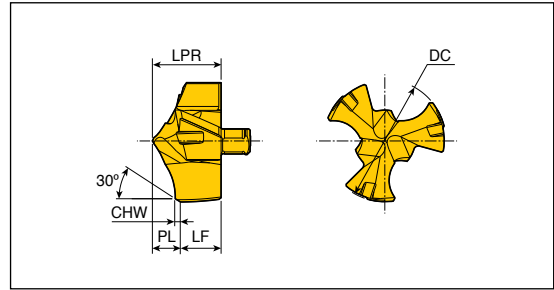

Designation	Dimension (mm)						Grade
	DC	LPR	PL	LF	CHW	SSC	TT5130
3ED-180-P+	18.0	10.10	4.07	6.03	0.70	18	●
181-P+	18.1	10.10	4.07	6.03	0.70	18	●
182-P+	18.2	10.10	4.07	6.03	0.70	18	●
183-P+	18.3	10.10	4.07	6.03	0.70	18	●
184-P+	18.4	10.10	4.07	6.03	0.70	18	●
185-P+	18.5	10.10	4.08	6.02	0.70	18	●
186-P+	18.6	10.10	4.08	6.02	0.70	18	●
187-P+	18.7	10.10	4.08	6.02	0.70	18	●
188-P+	18.8	10.10	4.08	6.02	0.70	18	●
189-P+	18.9	10.10	4.08	6.02	0.70	18	●
190-P+	19.0	10.70	4.26	6.44	0.70	19	●
191-P+	19.1	10.70	4.26	6.44	0.70	19	●
192-P+	19.2	10.70	4.26	6.44	0.70	19	●
193-P+	19.3	10.70	4.26	6.44	0.70	19	●
194-P+	19.4	10.70	4.26	6.44	0.70	19	●
195-P+	19.5	10.70	4.27	6.43	0.70	19	●
196-P+	19.6	10.70	4.27	6.43	0.70	19	●
197-P+	19.7	10.70	4.27	6.43	0.70	19	●
198-P+	19.8	10.70	4.27	6.43	0.70	19	●
199-P+	19.9	10.70	4.27	6.43	0.70	19	●
200-P+	20.0	11.30	4.44	6.86	0.70	20	●
201-P+	20.1	11.30	4.44	6.86	0.70	20	●
202-P+	20.2	11.30	4.44	6.86	0.70	20	●
203-P+	20.3	11.30	4.44	6.86	0.70	20	●
204-P+	20.4	11.30	4.44	6.86	0.70	20	●
205-P+	20.5	11.30	4.45	6.85	0.70	20	●
206-P+	20.6	11.30	4.45	6.85	0.70	20	●
207-P+	20.7	11.30	4.45	6.85	0.70	20	●
208-P+	20.8	11.30	4.45	6.85	0.70	20	●
209-P+	20.9	11.30	4.45	6.85	0.70	20	●



● SSC: Seat size code

●: Standard items

Drill heads

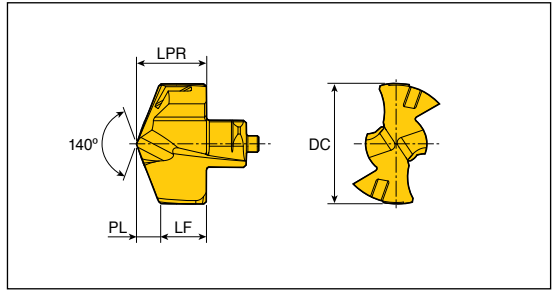

Designation	Dimension (mm)					Grade
	DC	LPR	PL	LF	SSC	
TCD - 060-P/M/K	6.0	4.0	0.96	3.04	6	●
061-P/M/K	6.1	4.0	0.98	3.02	6	●
062-P/M/K	6.2	4.0	1.00	3.00	6	●
063-P/M/K	6.3	4.0	1.01	2.99	6	●
064-P/M/K	6.4	4.0	1.03	2.97	6	●
065-P/M/K	6.5	4.3	1.18	3.12	6.5	●
066-P/M/K	6.6	4.3	1.20	3.10	6.5	●
067-P/M/K	6.7	4.3	1.22	3.08	6.5	●
068-P/M/K	6.8	4.3	1.23	3.07	6.5	●
069-P/M/K	6.9	4.3	1.25	3.05	6.5	●
070-P/M/K	7.0	4.6	1.01	3.59	7	●
071-P/M/K	7.1	4.6	1.03	3.57	7	●
072-P/M/K	7.2	4.6	1.05	3.55	7	●
073-P/M/K	7.3	4.6	1.06	3.54	7	●
074-P/M/K	7.4	4.6	1.08	3.52	7	●
075-P/M/K	7.5	4.6	1.10	3.50	7	●
076-P/M/K	7.6	4.6	1.12	3.48	7	●
077-P/M/K	7.7	4.6	1.14	3.46	7	●
078-P/M/K	7.8	4.6	1.16	3.44	7	●
079-P/M/K	7.9	4.6	1.17	3.43	7	●
080-P/M/K	8.0	5.4	1.20	4.20	8	●
081-P/M/K	8.1	5.4	1.22	4.18	8	●
082-P/M/K	8.2	5.4	1.24	4.16	8	●
083-P/M/K	8.3	5.4	1.25	4.15	8	●
084-P/M/K	8.4	5.4	1.27	4.13	8	●
085-P/M/K	8.5	5.4	1.29	4.11	8	●
086-P/M/K	8.6	5.4	1.31	4.09	8	●
087-P/M/K	8.7	5.4	1.33	4.07	8	●
088-P/M/K	8.8	5.4	1.35	4.05	8	●
089-P/M/K	8.9	5.4	1.36	4.04	8	●
090-P/M/K	9.0	5.8	1.35	4.45	9	●
091-P/M/K	9.1	5.8	1.37	4.43	9	●
092-P/M/K	9.2	5.8	1.39	4.41	9	●
093-P/M/K	9.3	5.8	1.40	4.40	9	●
094-P/M/K	9.4	5.8	1.42	4.38	9	●



• Drill head can be ordered by an application
 Order example) Diameter 10.0mm drill head for
 ISO P application: TCD-100-P TT9080

●: Standard items



Steel



Stainless steel



Cast iron

Drill heads

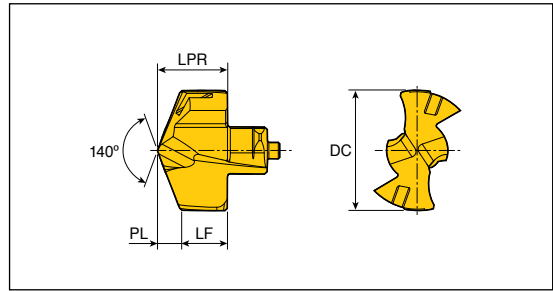

Designation	Dimension (mm)					SSC	Grade TT9080
	DC	LPR	PL	LF			
TCD - 095-P/M/K	9.5	5.8	1.44	4.36	9	●	
096-P/M/K	9.6	5.8	1.46	4.34	9	●	
097-P/M/K	9.7	5.8	1.48	4.32	9	●	
098-P/M/K	9.8	5.8	1.50	4.30	9	●	
099-P/M/K	9.9	5.8	1.51	4.29	9	●	
100-P/M/K	10.0	6.2	1.50	4.70	10	●	
101-P/M/K	10.1	6.2	1.52	4.68	10	●	
102-P/M/K	10.2	6.2	1.54	4.66	10	●	
103-P/M/K	10.3	6.2	1.55	4.65	10	●	
104-P/M/K	10.4	6.2	1.57	4.63	10	●	
105-P/M/K	10.5	6.2	1.59	4.61	10	●	
106-P/M/K	10.6	6.2	1.61	4.59	10	●	
107-P/M/K	10.7	6.2	1.63	4.57	10	●	
108-P/M/K	10.8	6.2	1.65	4.55	10	●	
109-P/M/K	10.9	6.2	1.66	4.54	10	●	
110-P/M/K	11.0	6.6	1.67	4.93	11	●	
111-P/M/K	11.1	6.6	1.69	4.91	11	●	
112-P/M/K	11.2	6.6	1.71	4.89	11	●	
113-P/M/K	11.3	6.6	1.72	4.88	11	●	
114-P/M/K	11.4	6.6	1.74	4.86	11	●	
115-P/M/K	11.5	6.6	1.76	4.84	11	●	
116-P/M/K	11.6	6.6	1.78	4.82	11	●	
117-P/M/K	11.7	6.6	1.80	4.80	11	●	
118-P/M/K	11.8	6.6	1.82	4.78	11	●	
119-P/M/K	11.9	6.6	1.83	4.77	11	●	
120-P/M/K	12.0	7.0	1.82	5.18	12	●	
121-P/M/K	12.1	7.0	1.84	5.16	12	●	
122-P/M/K	12.2	7.0	1.86	5.14	12	●	
123-P/M/K	12.3	7.0	1.87	5.13	12	●	
124-P/M/K	12.4	7.0	1.89	5.11	12	●	
125-P/M/K	12.5	7.0	1.91	5.09	12	●	
126-P/M/K	12.6	7.0	1.93	5.07	12	●	
127-P/M/K	12.7	7.0	1.95	5.05	12	●	
128-P/M/K	12.8	7.0	1.97	5.03	12	●	
129-P/M/K	12.9	7.0	1.98	5.02	12	●	



• Drill head can be ordered by an application
 Order example) Diameter 10.0mm drill head for
 ISO P application: TCD-100-P TT9080

• Standard items

P Steel **M** Stainless steel **K** Cast iron

Drill heads

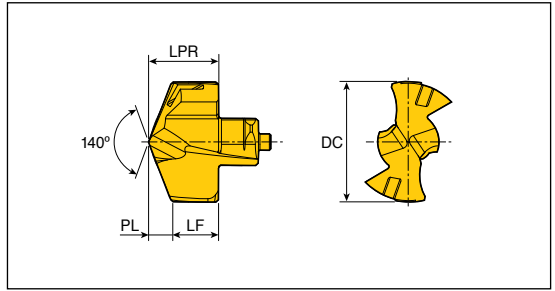

Designation	Dimension (mm)					Grade
	DC	LPR	PL	LF	SSC	
TCD - 130-P/M/K	13.0	7.6	1.96	5.64	13	●
131-P/M/K	13.1	7.6	1.98	5.62	13	●
132-P/M/K	13.2	7.6	2.00	5.60	13	●
133-P/M/K	13.3	7.6	2.01	5.59	13	●
134-P/M/K	13.4	7.6	2.03	5.57	13	●
135-P/M/K	13.5	7.6	2.05	5.55	13	●
136-P/M/K	13.6	7.6	2.07	5.53	13	●
137-P/M/K	13.7	7.6	2.09	5.51	13	●
138-P/M/K	13.8	7.6	2.11	5.49	13	●
139-P/M/K	13.9	7.6	2.12	5.48	13	●
140-P/M/K	14.0	8.1	2.12	5.98	14	●
141-P/M/K	14.1	8.1	2.14	5.96	14	●
142-P/M/K	14.2	8.1	2.16	5.94	14	●
143-P/M/K	14.3	8.1	2.17	5.93	14	●
144-P/M/K	14.4	8.1	2.19	5.91	14	●
145-P/M/K	14.5	8.1	2.21	5.89	14	●
146-P/M/K	14.6	8.1	2.23	5.87	14	●
147-P/M/K	14.7	8.1	2.25	5.85	14	●
148-P/M/K	14.8	8.1	2.27	5.83	14	●
149-P/M/K	14.9	8.1	2.28	5.82	14	●
150-P/M/K	15.0	8.7	2.27	6.43	15	●
151-P/M/K	15.1	8.7	2.29	6.41	15	●
152-P/M/K	15.2	8.7	2.31	6.39	15	●
153-P/M/K	15.3	8.7	2.32	6.38	15	●
154-P/M/K	15.4	8.7	2.34	6.36	15	●
155-P/M/K	15.5	8.7	2.36	6.34	15	●
156-P/M/K	15.6	8.7	2.38	6.32	15	●
157-P/M/K	15.7	8.7	2.40	6.30	15	●
158-P/M/K	15.8	8.7	2.42	6.28	15	●
159-P/M/K	15.9	8.7	2.43	6.27	15	●
160-P/M/K	16.0	9.3	2.42	6.88	16	●
161-P/M/K	16.1	9.3	2.44	6.86	16	●
162-P/M/K	16.2	9.3	2.46	6.84	16	●
163-P/M/K	16.3	9.3	2.47	6.83	16	●
164-P/M/K	16.4	9.3	2.49	6.81	16	●



• Drill head can be ordered by an application
 Order example) Diameter 10.0mm drill head for
 ISO P application: TCD-100-P TT9080

●: Standard items



Steel



Stainless steel



Cast iron

Drill heads

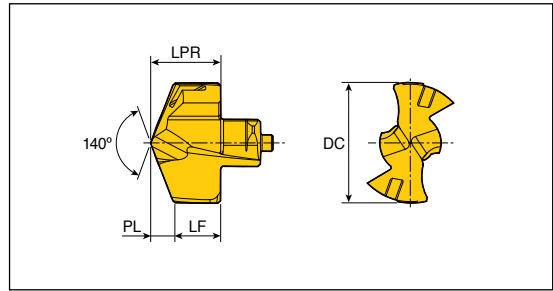

Designation	Dimension (mm)					Grade
	DC	LPR	PL	LF	SSC	TT9080
TCD - 165-P/M/K	16.5	9.3	2.51	6.79	16	●
166-P/M/K	16.6	9.3	2.53	6.77	16	●
167-P/M/K	16.7	9.3	2.55	6.75	16	●
168-P/M/K	16.8	9.3	2.57	6.73	16	●
169-P/M/K	16.9	9.3	2.58	6.72	16	●
170-P/M/K	17.0	9.9	2.59	7.31	17	●
171-P/M/K	17.1	9.9	2.61	7.29	17	●
172-P/M/K	17.2	9.9	2.63	7.27	17	●
173-P/M/K	17.3	9.9	2.64	7.26	17	●
174-P/M/K	17.4	9.9	2.66	7.24	17	●
175-P/M/K	17.5	9.9	2.68	7.22	17	●
176-P/M/K	17.6	9.9	2.70	7.20	17	●
177-P/M/K	17.7	9.9	2.72	7.18	17	●
178-P/M/K	17.8	9.9	2.74	7.16	17	●
179-P/M/K	17.9	9.9	2.75	7.15	17	●
180-P/M/K	18.0	10.5	2.73	7.77	18	●
181-P/M/K	18.1	10.5	2.75	7.75	18	●
182-P/M/K	18.2	10.5	2.77	7.73	18	●
183-P/M/K	18.3	10.5	2.78	7.72	18	●
184-P/M/K	18.4	10.5	2.80	7.70	18	●
185-P/M/K	18.5	10.5	2.82	7.68	18	●
186-P/M/K	18.6	10.5	2.84	7.66	18	●
187-P/M/K	18.7	10.5	2.86	7.64	18	●
188-P/M/K	18.8	10.5	2.88	7.62	18	●
189-P/M/K	18.9	10.5	2.89	7.61	18	●
190-P/M/K	19.0	11.0	2.88	8.12	19	●
191-P/M/K	19.1	11.0	2.90	8.10	19	●
192-P/M/K	19.2	11.0	2.92	8.08	19	●
193-P/M/K	19.3	11.0	2.93	8.07	19	●
194-P/M/K	19.4	11.0	2.95	8.05	19	●
195-P/M/K	19.5	11.0	2.97	8.03	19	●
196-P/M/K	19.6	11.0	2.99	8.01	19	●
197-P/M/K	19.7	11.0	3.01	7.99	19	●
198-P/M/K	19.8	11.0	3.03	7.97	19	●
199-P/M/K	19.9	11.0	3.04	7.96	19	●



● Drill head can be ordered by an application
 Order example) Diameter 10.0mm drill head for
 ISO P application: TCD-100-P TT9080

●: Standard items

P Steel **M** Stainless steel **K** Cast iron

Drill heads

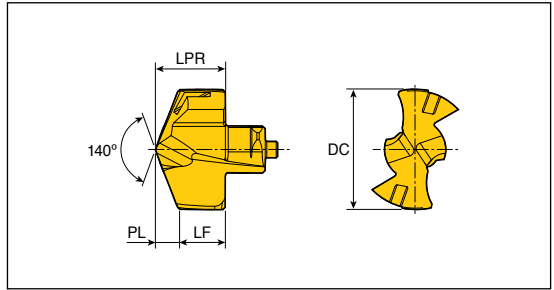

Designation	Dimension (mm)					Grade
	DC	LPR	PL	LF	SSC	TT9080
TCD - 200-P/M/K	20.0	11.6	3.02	8.58	20	●
201-P/M/K	20.1	11.6	3.04	8.56	20	●
202-P/M/K	20.2	11.6	3.06	8.54	20	●
203-P/M/K	20.3	11.6	3.07	8.53	20	●
204-P/M/K	20.4	11.6	3.09	8.51	20	●
205-P/M/K	20.5	11.6	3.11	8.49	20	●
206-P/M/K	20.6	11.6	3.13	8.47	20	●
207-P/M/K	20.7	11.6	3.15	8.45	20	●
208-P/M/K	20.8	11.6	3.17	8.43	20	●
209-P/M/K	20.9	11.6	3.18	8.42	20	●
210-P/M/K	21.0	12.1	3.18	8.92	21	●
211-P/M/K	21.1	12.1	3.20	8.90	21	●
212-P/M/K	21.2	12.1	3.22	8.88	21	●
213-P/M/K	21.3	12.1	3.23	8.87	21	●
214-P/M/K	21.4	12.1	3.25	8.85	21	●
215-P/M/K	21.5	12.1	3.27	8.83	21	●
216-P/M/K	21.6	12.1	3.29	8.81	21	●
217-P/M/K	21.7	12.1	3.31	8.79	21	●
218-P/M/K	21.8	12.1	3.33	8.77	21	●
219-P/M/K	21.9	12.1	3.34	8.76	21	●
220-P/M/K	22.0	12.7	3.24	9.46	22	●
221-P/M/K	22.1	12.7	3.26	9.44	22	●
222-P/M/K	22.2	12.7	3.28	9.42	22	●
223-P/M/K	22.3	12.7	3.29	9.41	22	●
224-P/M/K	22.4	12.7	3.31	9.39	22	●
225-P/M/K	22.5	12.7	3.33	9.37	22	●
226-P/M/K	22.6	12.7	3.35	9.35	22	●
227-P/M/K	22.7	12.7	3.37	9.33	22	●
228-P/M/K	22.8	12.7	3.39	9.31	22	●
229-P/M/K	22.9	12.7	3.40	9.30	22	●
230-P/M/K	23.0	13.3	3.46	9.84	23	●
231-P/M/K	23.1	13.3	3.48	9.82	23	●
232-P/M/K	23.2	13.3	3.50	9.80	23	●
233-P/M/K	23.3	13.3	3.51	9.79	23	●
234-P/M/K	23.4	13.3	3.53	9.77	23	●



• Drill head can be ordered by an application
 Order example) Diameter 10.0mm drill head for
 ISO P application: TCD-100-P TT9080

●: Standard items

P Steel **M** Stainless steel **K** Cast iron

Drill heads

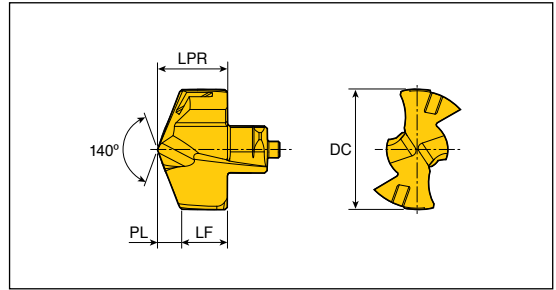

Designation	Dimension (mm)					Grade
	DC	LPR	PL	LF	SSC	
TCD - 235-P/M/K	23.5	13.3	3.55	9.75	23	●
236-P/M/K	23.6	13.3	3.57	9.73	23	●
237-P/M/K	23.7	13.3	3.59	9.71	23	●
238-P/M/K	23.8	13.3	3.61	9.69	23	●
239-P/M/K	23.9	13.3	3.62	9.68	23	●
240-P/M/K	24.0	13.9	3.62	10.28	24	●
241-P/M/K	24.1	13.9	3.64	10.26	24	●
242-P/M/K	24.2	13.9	3.66	10.24	24	●
243-P/M/K	24.3	13.9	3.67	10.23	24	●
244-P/M/K	24.4	13.9	3.69	10.21	24	●
245-P/M/K	24.5	13.9	3.71	10.19	24	●
246-P/M/K	24.6	13.9	3.73	10.17	24	●
247-P/M/K	24.7	13.9	3.75	10.15	24	●
248-P/M/K	24.8	13.9	3.77	10.13	24	●
249-P/M/K	24.9	13.9	3.78	10.12	24	●
250-P/M/K	25.0	14.5	3.80	10.70	25	●
251-P/M/K	25.1	14.5	3.82	10.68	25	●
252-P/M/K	25.2	14.5	3.84	10.66	25	●
253-P/M/K	25.3	14.5	3.85	10.65	25	●
254-P/M/K	25.4	14.5	3.87	10.63	25	●
255-P/M/K	25.5	14.5	3.89	10.61	25	●
256-P/M/K	25.6	14.5	3.91	10.59	25	●
257-P/M/K	25.7	14.5	3.93	10.57	25	●
258-P/M/K	25.8	14.5	3.95	10.55	25	●
259-P/M/K	25.9	14.5	3.96	10.54	25	●



• Drill head can be ordered by an application
 Order example) Diameter 10.0mm drill head for
 ISO P application: TCD-100-P TT9080

• Standard items

- P Steel
- M Stainless steel
- K Cast iron

Self-centering drill heads

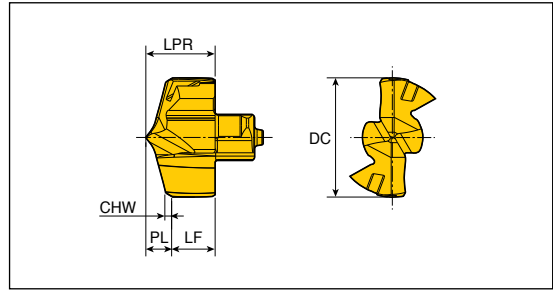

Designation	Dimension (mm)						Grade
	DC	LPR	PL	LF	CHW	SSC	TT9080
TCD-060-P+	6.0	4.00	1.46	2.54	0.5	6	●
065-P+	6.5	4.30	1.55	2.75	0.5	6.5	●
068-P+	6.8	4.30	1.59	2.71	0.5	6.5	●
070-P+	7.0	4.60	1.64	2.96	0.5	7	●
072-P+	7.2	4.60	1.67	2.93	0.5	7	●
075-P+	7.5	4.60	1.71	2.89	0.5	7	●
080-P+	8.0	5.40	1.81	3.59	0.5	8	●
081-P+	8.1	5.40	1.82	3.58	0.5	8	●
082-P+	8.2	5.40	1.84	3.56	0.5	8	●
083-P+	8.3	5.40	1.85	3.55	0.5	8	●
085-P+	8.5	5.40	1.88	3.52	0.5	8	●
086-P+	8.6	5.40	1.89	3.51	0.5	8	●
087-P+	8.7	5.40	1.90	3.50	0.5	8	●
088-P+	8.8	5.40	1.92	3.48	0.5	8	●
089-P+	8.9	5.40	1.93	3.47	0.5	8	●
090-P+	9.0	5.80	1.98	3.82	0.5	9	●
093-P+	9.3	5.80	2.02	3.78	0.5	9	●
095-P+	9.5	5.80	2.05	3.75	0.5	9	●
096-P+	9.6	5.80	2.06	3.74	0.5	9	●
097-P+	9.7	5.80	2.07	3.73	0.5	9	●
098-P+	9.8	5.80	2.09	3.71	0.5	9	●
099-P+	9.9	5.80	2.10	3.70	0.5	9	●
100-P+	10.0	6.20	2.33	3.87	0.7	10	●
101-P+	10.1	6.20	2.34	3.86	0.7	10	●
102-P+	10.2	6.20	2.36	3.84	0.7	10	●
103-P+	10.3	6.20	2.37	3.83	0.7	10	●
105-P+	10.5	6.20	2.40	3.80	0.7	10	●
106-P+	10.6	6.20	2.41	3.79	0.7	10	●
107-P+	10.7	6.20	2.42	3.78	0.7	10	●
108-P+	10.8	6.20	2.44	3.76	0.7	10	●
109-P+	10.9	6.20	2.45	3.75	0.7	10	●
110-P+	11.0	6.60	2.50	4.10	0.7	11	●
111-P+	11.1	6.60	2.51	4.09	0.7	11	●
112-P+	11.2	6.60	2.53	4.07	0.7	11	●
113-P+	11.3	6.60	2.54	4.06	0.7	11	●



● SSC: Seat size code

●: Standard items

Self-centering drill heads

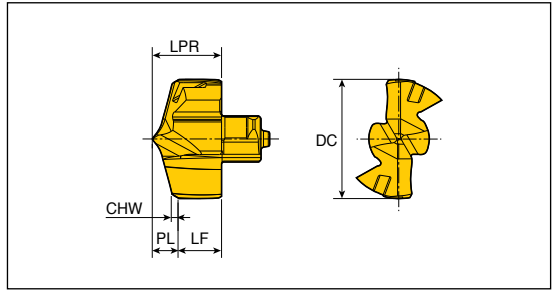

Designation	Dimension (mm)						Grade TT9080
	DC	LPR	PL	LF	CHW	SSC	
TCD-114-P+	11.4	6.60	2.55	4.05	0.7	11	●
115-P+	11.5	6.60	2.57	4.03	0.7	11	●
116-P+	11.6	6.60	2.58	4.02	0.7	11	●
117-P+	11.7	6.60	2.59	4.01	0.7	11	●
118-P+	11.8	6.60	2.61	3.99	0.7	11	●
119-P+	11.9	6.60	2.62	3.98	0.7	11	●
120-P+	12.0	7.00	2.67	4.33	0.7	12	●
121-P+	12.1	7.00	2.68	4.32	0.7	12	●
122-P+	12.2	7.00	2.70	4.30	0.7	12	●
123-P+	12.3	7.00	2.71	4.29	0.7	12	●
124-P+	12.4	7.00	2.72	4.28	0.7	12	●
125-P+	12.5	7.00	2.74	4.26	0.7	12	●
126-P+	12.6	7.00	2.75	4.25	0.7	12	●
127-P+	12.7	7.00	2.76	4.24	0.7	12	●
128-P+	12.8	7.00	2.78	4.22	0.7	12	●
130-P+	13.0	7.60	2.85	4.75	0.7	13	●
131-P+	13.1	7.60	2.86	4.74	0.7	13	●
132-P+	13.2	7.60	2.88	4.72	0.7	13	●
133-P+	13.3	7.60	2.89	4.71	0.7	13	●
134-P+	13.4	7.60	2.90	4.70	0.7	13	●
135-P+	13.5	7.60	2.92	4.68	0.7	13	●
136-P+	13.6	7.60	2.93	4.67	0.7	13	●
137-P+	13.7	7.60	2.94	4.66	0.7	13	●
138-P+	13.8	7.60	2.96	4.64	0.7	13	●
139-P+	13.9	7.60	2.97	4.63	0.7	13	●
140-P+	14.0	8.15	3.02	5.13	0.7	14	●
141-P+	14.1	8.15	3.03	5.12	0.7	14	●
142-P+	14.2	8.15	3.05	5.10	0.7	14	●
143-P+	14.3	8.15	3.06	5.09	0.7	14	●
144-P+	14.4	8.15	3.07	5.08	0.7	14	●
145-P+	14.5	8.15	3.09	5.06	0.7	14	●
146-P+	14.6	8.15	3.10	5.05	0.7	14	●
147-P+	14.7	8.15	3.11	5.04	0.7	14	●
148-P+	14.8	8.15	3.13	5.02	0.7	14	●
150-P+	15.0	8.73	3.19	5.54	0.7	15	●



● SSC: Seat size code

●: Standard items

Self-centering drill heads

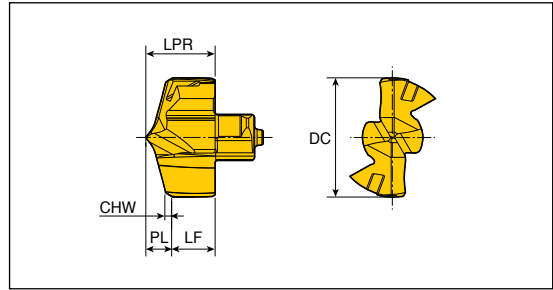

Designation	Dimension (mm)						Grade TT9080
	DC	LPR	PL	LF	CHW	SSC	
TCD-151-P+	15.1	8.73	3.20	5.53	0.7	15	●
152-P+	15.2	8.73	3.22	5.51	0.7	15	●
153-P+	15.3	8.73	3.23	5.50	0.7	15	●
154-P+	15.4	8.73	3.24	5.49	0.7	15	●
155-P+	15.5	8.73	3.26	5.47	0.7	15	●
156-P+	15.6	8.73	3.27	5.46	0.7	15	●
157-P+	15.7	8.73	3.28	5.45	0.7	15	●
158-P+	15.8	8.73	3.30	5.43	0.7	15	●
159-P+	15.9	8.73	3.31	5.42	0.7	15	●
160-P+	16.0	9.30	3.46	5.84	0.81	16	●
161-P+	16.1	9.30	3.47	5.83	0.81	16	●
162-P+	16.2	9.30	3.49	5.81	0.81	16	●
163-P+	16.3	9.30	3.50	5.80	0.81	16	●
164-P+	16.4	9.30	3.51	5.79	0.81	16	●
165-P+	16.5	9.30	3.53	5.77	0.81	16	●
166-P+	16.6	9.30	3.54	5.76	0.81	16	●
167-P+	16.7	9.30	3.55	5.75	0.81	16	●
168-P+	16.8	9.30	3.57	5.73	0.81	16	●
170-P+	17.0	9.90	3.63	6.27	0.81	17	●
171-P+	17.1	9.90	3.64	6.26	0.81	17	●
172-P+	17.2	9.90	3.66	6.24	0.81	17	●
173-P+	17.3	9.90	3.67	6.23	0.81	17	●
174-P+	17.4	9.90	3.68	6.22	0.81	17	●
175-P+	17.5	9.90	3.70	6.20	0.81	17	●
176-P+	17.6	9.90	3.71	6.19	0.81	17	●
177-P+	17.7	9.90	3.72	6.18	0.81	17	●
178-P+	17.8	9.90	3.74	6.16	0.81	17	●
179-P+	17.9	9.90	3.75	6.15	0.81	17	●
180-P+	18.0	10.50	3.81	6.69	0.81	18	●
181-P+	18.1	10.50	3.82	6.68	0.81	18	●
182-P+	18.2	10.50	3.84	6.66	0.81	18	●
183-P+	18.3	10.50	3.85	6.65	0.81	18	●
185-P+	18.5	10.50	3.88	6.62	0.81	18	●
186-P+	18.6	10.50	3.89	6.61	0.81	18	●
187-P+	18.7	10.50	3.90	6.60	0.81	18	●



● SSC: Seat size code

●: Standard items

Self-centering drill heads

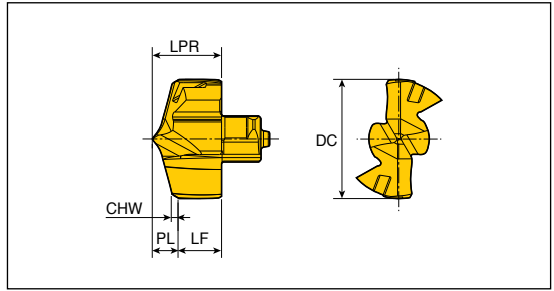

Designation	Dimension (mm)						Grade TT9080
	DC	LPR	PL	LF	CHW	SSC	
TCD-188-P+	18.8	10.50	3.92	6.58	0.81	18	●
190-P+	19.0	11.00	3.98	7.02	0.81	19	●
191-P+	19.1	11.00	3.99	7.01	0.81	19	●
192-P+	19.2	11.00	4.01	6.99	0.81	19	●
193-P+	19.3	11.00	4.02	6.98	0.81	19	●
194-P+	19.4	11.00	4.03	6.97	0.81	19	●
195-P+	19.5	11.00	4.05	6.95	0.81	19	●
196-P+	19.6	11.00	4.06	6.94	0.81	19	●
197-P+	19.7	11.00	4.07	6.93	0.81	19	●
198-P+	19.8	11.00	4.09	6.91	0.81	19	●
199-P+	19.9	11.00	4.10	6.90	0.81	19	●
200-P+	20.0	11.60	4.15	7.45	0.81	20	●
201-P+	20.1	11.60	4.16	7.44	0.81	20	●
202-P+	20.2	11.60	4.18	7.42	0.81	20	●
205-P+	20.5	11.60	4.22	7.38	0.81	20	●
206-P+	20.6	11.60	4.23	7.37	0.81	20	●
207-P+	20.7	11.60	4.24	7.36	0.81	20	●
210-P+	21.0	12.18	4.32	7.86	0.81	21	●
212-P+	21.2	12.18	4.35	7.83	0.81	21	●
213-P+	21.3	12.18	4.36	7.82	0.81	21	●
214-P+	21.4	12.18	4.37	7.81	0.81	21	●
215-P+	21.5	12.18	4.39	7.79	0.81	21	●
218-P+	21.8	12.18	4.43	7.75	0.81	21	●
220-P+	22.0	12.76	4.50	8.26	0.81	22	●
225-P+	22.5	12.76	4.57	8.19	0.81	22	●
229-P+	22.9	12.76	4.62	8.14	0.81	22	●
230-P+	23.0	13.33	4.67	8.66	0.81	23	●
235-P+	23.5	13.33	4.74	8.59	0.81	23	●
240-P+	24.0	13.90	4.84	9.06	0.81	24	●
245-P+	24.5	13.90	4.91	8.99	0.81	24	●
250-P+	25.0	14.50	5.01	9.49	0.81	25	●
254-P+	25.4	14.50	5.06	9.44	0.81	25	●
255-P+	25.5	14.50	5.08	9.42	0.81	25	●
256-P+	25.6	14.50	5.09	9.41	0.81	25	●
257-P+	25.7	14.50	5.10	9.40	0.81	25	●

● SSC: Seat size code

●: Standard items



Drill heads for flat bottom hole

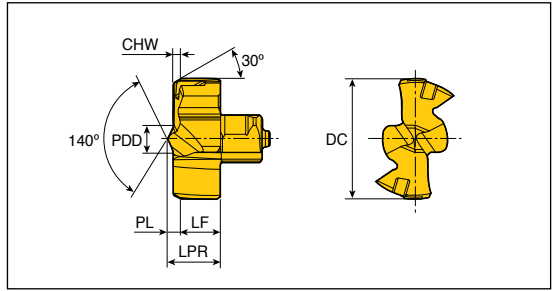

Designation	Dimension (mm)							Grade
	DC	PDD	LPR	PL	LF	CHW	SSC	TT9080
TCD - 080-F	8.0	2.33	4.4	1.09	3.3	0.7	8	●
085-F	8.5	2.33	4.4	1.09	3.3	0.7	8	●
090-F	9.0	2.29	4.6	1.11	3.5	0.7	9	●
095-F	9.5	2.29	4.6	1.11	3.5	0.7	9	●
100-F	10.0	2.44	4.9	1.17	3.7	0.7	10	●
105-F	10.5	2.44	4.9	1.17	3.7	0.7	10	●
110-F	11.0	3.09	5.1	1.25	3.8	0.7	11	●
115-F	11.5	3.09	5.1	1.25	3.8	0.7	11	●
120-F	12.0	2.95	5.4	1.26	4.1	0.7	12	●
125-F	12.5	2.95	5.4	1.26	4.1	0.7	12	●
130-F	13.0	3.04	5.7	1.30	4.4	0.7	13	●
135-F	13.5	3.04	5.7	1.30	4.4	0.7	13	●
140-F	14.0	3.30	6.1	1.31	4.8	0.7	14	●
145-F	14.5	3.30	6.1	1.31	4.8	0.7	14	●
150-F	15.0	3.54	6.6	1.35	5.23	0.7	15	●
155-F	15.5	3.54	6.6	1.35	5.23	0.7	15	●
160-F	16.0	3.74	7.0	1.39	5.6	0.7	16	●
165-F	16.5	3.74	7.0	1.39	5.6	0.7	16	●
170-F	17.0	3.75	7.3	1.40	5.9	0.7	17	●
175-F	17.5	3.75	7.3	1.40	5.9	0.7	17	●
180-F	18.0	3.85	7.6	1.42	6.18	0.7	18	●
185-F	18.5	3.85	7.6	1.42	6.18	0.7	18	●
190-F	19.0	3.86	7.9	1.44	6.5	0.7	19	●
195-F	19.5	3.86	7.9	1.44	6.5	0.7	19	●
200-F	20.0	6.76	9.3	1.77	7.5	0.7	20	●
205-F	20.5	6.76	9.3	1.77	7.5	0.7	20	●
210-F	21.0	6.98	9.7	1.79	7.9	0.7	21	●
215-F	21.5	6.98	9.7	1.79	7.9	0.7	21	●
220-F	22.0	7.42	10.0	1.81	8.2	0.7	22	●
225-F	22.5	7.42	10.0	1.81	8.2	0.7	22	●
230-F	23.0	7.60	10.4	1.83	8.6	0.7	23	●
235-F	23.5	7.60	10.4	1.83	8.6	0.7	23	●
240-F	24.0	8.13	10.9	1.86	9.0	0.7	24	●
245-F	24.5	8.13	10.9	1.86	9.0	0.7	24	●
250-F	25.0	8.16	11.3	1.89	9.4	0.7	25	●



● SSC: Seat size code

●: Standard items

AOMT 060204-C45

Chamfering inserts for pre-thread hole

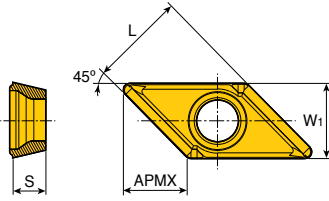

Size	Dimension (mm)			
	W1	L	S	APMX
06	4.5	5.66	1.96	4.0

Insert	Designation	Coated						Uncoated	
		TT9080	TT9030	TT8020	TT6030	TT9300	TT7400		
	AOMT 060204-C45	●						K10	



●: Standard items

CRNG 0802-45CD

Chamfering inserts for chamfering ring

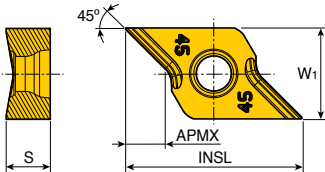

Size	Dimension (mm)			
	W1	INSL	S	APMX
08	7.5	14.80	3.65	3.3

Insert	Designation	Coated						Uncoated	
		TT9080	TT9030	TT8020	TT6030	TT9300	TT7400		
	CRNG 0802-45CD	●						K10	



●: Standard items

TCD...P-CO+

Self-centering drill heads

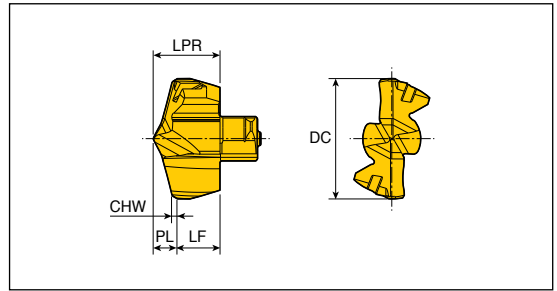

Designation	Dimension (mm)						Grade
	DC	LPR	PL	LF	CHW	SSC	TT9080
TCD-159-P-CO+	15.9	8.73	3.17	5.56	0.7	15	●
169-P-CO+	16.9	9.30	3.34	5.96	0.81	16	●
179-P-CO+	17.9	9.90	3.50	6.40	0.81	17	●
189-P-CO+	18.9	10.50	3.66	6.84	0.81	18	●
199-P-CO+	19.9	11.00	3.82	7.18	0.81	19	●
209-P-CO+	20.9	11.60	3.98	7.62	0.81	20	●
219-P-CO+	21.9	12.18	4.15	8.03	0.81	21	●
229-P-CO+	22.9	12.76	4.31	8.45	0.81	22	●
239-P-CO+	23.9	13.33	4.48	8.85	0.81	23	●
249-P-CO+	24.9	13.90	4.64	9.26	0.81	24	●
259-P-CO+	25.9	14.50	4.81	9.69	0.81	25	●



● SSC: Seat size code

● Standard items

SPGX...DW

Inserts

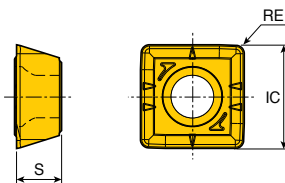

Size	Dimension (mm)			
	IC	S	RE	
06	6.07	2.38	0.4	
07	8.02	3.97	0.8	
09	9.91	4.30	0.8	
11	11.62	4.80	0.8	
14	14.41	5.20	1.2	

Insert	Designation	Coated						Uncoated	
		TT9080	TT8020	TT9900	TT9030	TT6080	TT7400	K10	
	SPGX 060204 DW	●							
	07T308 DW	●							
	090408 DW	●							
	110408 DW	●							
	140512 DW	●							



● Standard items

Drill heads

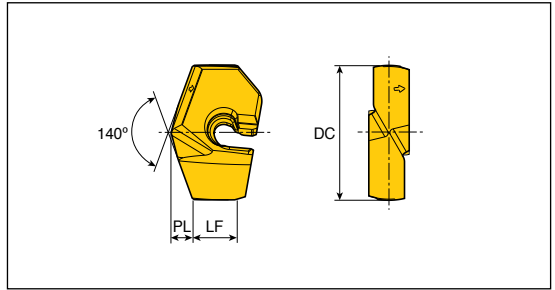

Designation	Dimension (mm)				Grade TT9080
	DC	PL	LF	SSC	
LCD- 200-P	20.0	3.11	6.54	20	●
205-P	20.5	3.20	6.45	20	●
210-P	21.0	3.29	6.36	21	●
215-P	21.5	3.38	6.27	21	●
220-P	22.0	3.42	7.12	22	●
225-P	22.5	3.51	7.03	22	●
230-P	23.0	3.60	6.94	23	●
235-P	23.5	3.69	6.85	23	●
240-P	24.0	3.73	7.03	24	●
245-P	24.5	3.82	6.94	24	●
250-P	25.0	3.91	6.85	25	●
255-P	25.5	4.00	6.76	25	●
260-P	26.0	4.04	7.51	26	●
265-P	26.5	4.13	7.42	26	●
270-P	27.0	4.22	7.33	27	●
275-P	27.5	4.31	7.24	27	●
280-P	28.0	4.35	7.39	28	●
285-P	28.5	4.44	7.30	28	●
290-P	29.0	4.53	7.21	29	●
295-P	29.5	4.62	7.12	29	●
300-P	30.0	4.67	9.47	30	●
305-P	30.5	4.76	9.38	30	●
310-P	31.0	4.85	9.29	31	●
315-P	31.5	4.94	9.20	31	●
320-P	32.0	4.98	9.55	32	●
325-P	32.5	5.07	9.46	32	●
330-P	33.0	5.16	9.37	33	●
335-P	33.5	5.25	9.28	33	●
340-P	34.0	5.34	9.19	34	●
345-P	34.5	5.44	9.10	34	●
350-P	35.0	5.44	11.12	35	●
355-P	35.5	5.53	11.03	35	●
360-P	36.0	5.62	10.94	36	●
365-P	36.5	5.71	10.85	36	●
370-P	37.0	5.80	10.76	37	●



● SSC: Seat size code

●: Standard items

Drill heads for flat bottom hole

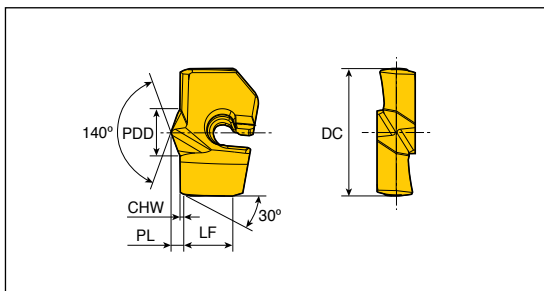

Designation	Dimension (mm)						Grade
	DC	PL	LF	CHW	SSC	PDD	TT9080
LCD - 200-F	20.0	2.18	7.63	0.7	20	8.3	●
205-F	20.5	2.18	7.63	0.7	20	8.3	●
210-F	21.0	2.18	7.63	0.7	21	8.3	●
215-F	21.5	2.18	7.63	0.7	21	8.3	●
220-F	22.0	2.38	8.17	0.7	22	9.0	●
225-F	22.5	2.38	8.17	0.7	22	9.0	●
230-F	23.0	2.38	8.17	0.7	23	9.0	●
235-F	23.5	2.38	8.17	0.7	23	9.0	●
240-F	24.0	2.52	8.10	0.7	24	10.0	●
245-F	24.5	2.52	8.10	0.7	24	10.0	●
250-F	25.0	2.52	8.10	0.7	25	10.0	●
255-F	25.5	2.52	8.10	0.7	25	10.0	●
260-F	26.0	2.48	9.84	0.7	26	10.5	●
265-F	26.5	2.48	9.84	0.7	26	10.5	●
270-F	27.0	2.48	9.84	0.7	27	10.5	●
275-F	27.5	2.48	9.84	0.7	27	10.5	●
280-F	28.0	2.72	9.50	0.7	28	11.6	●
285-F	28.5	2.72	9.50	0.7	28	11.6	●
290-F	29.0	2.72	9.50	0.7	29	11.6	●
295-F	29.5	2.72	9.50	0.7	29	11.6	●
300-F	30.0	2.80	11.63	0.7	30	12.4	●
305-F	30.5	2.80	11.63	0.7	30	12.4	●
310-F	31.0	2.80	11.63	0.7	31	12.4	●
315-F	31.5	2.80	11.63	0.7	31	12.4	●
320-F	32.0	3.13	11.59	0.7	32	13.6	●
325-F	32.5	3.13	11.59	0.7	32	13.6	●
330-F	33.0	3.13	11.59	0.7	33	13.6	●
335-F	33.5	3.13	11.59	0.7	33	13.6	●
340-F	34.0	3.13	11.59	0.7	34	13.6	●
345-F	34.5	3.13	11.59	0.7	34	13.6	●
350-F	35.0	3.31	13.20	0.7	35	14.6	●
355-F	35.5	3.31	13.20	0.7	35	14.6	●
360-F	36.0	3.31	13.20	0.7	36	14.6	●
365-F	36.5	3.31	13.20	0.7	36	14.6	●
370-F	37.0	3.31	13.20	0.7	37	14.6	●



● SSC: Seat size code

●: Standard items



XCGT ...-C

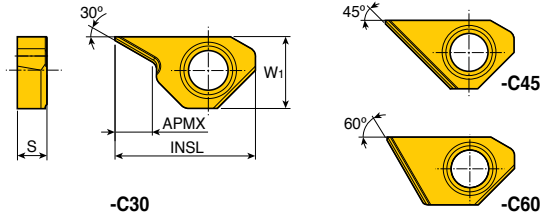

Chamfering inserts for T-CHAMFER holder



Size	Dimension (mm)			
	W1	INSL	S	APMX
06-C30	6.18	12.3	2.8	3.49
09-C30	8.50	16.0	3.3	4.43
06-C45	6.18	12.3	2.8	5.89
09-C45	8.50	16.0	3.3	8.07
06-C60	6.18	12.3	2.8	3.43
09-C60	8.50	16.0	3.3	4.78

Insert	Designation	Coated						Uncoated	
		TT9080	TT9030	TT8020	TT6030	TT9300	TT7400		K10
	XCGT 0603-C30	•							
	0903-C30	•							
	XCGT 0603-C45	•							
	0903-C45	•							
	XCGT 0603-C60	•							
	0903-C60	•							

•: Standard items



XCGT...TA



Inserts

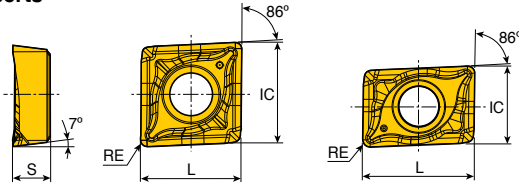

XCGT 0401

Size	Dimension (mm)			
	IC	L	S	RE
04	4.4	6.4	1.70	0.4
05	5.6	5.6	2.10	0.4
06	6.4	6.4	2.38	0.4
07	7.5	7.5	3.18	0.4
08	8.4	8.4	3.18	0.4
10	10.5	10.5	3.97	0.4
13	13.4	13.4	4.76	0.4
17	17.5	17.5	5.56	0.8

• For aluminum alloy

Insert	Designation	Turning		Drilling	Coated					Uncoated		
		ap (mm)	Feed (mm/rev)	Feed (mm/rev)	TT9080	TT8020	TT9300	TT9030	TT6030	TT7400	K10	
<p>Right hand shown (XCGT 0401)</p>	XCGT 040104R TA	0.2-1.8	0.02-0.15	0.02-0.09							•	
	040104L TA	0.2-1.8	0.02-0.15	0.02-0.09							•	
	050204 TA	0.2-2.2	0.03-0.18	0.02-0.11							•	
	060204 TA	0.3-2.5	0.03-0.20	0.03-0.12							•	
	070304 TA	0.4-2.8	0.05-0.22	0.03-0.13							•	
	080304 TA	0.4-3.2	0.06-0.25	0.03-0.13							•	
	10T304 TA	0.5-3.5	0.06-0.30	0.03-0.13							•	
	130404 TA	0.6-4.3	0.08-0.33	0.03-0.13							•	
	170508 TA	0.7-5.3	0.10-0.38	0.03-0.13							•	



• Standard items

XCMT..R-GV



Inserts

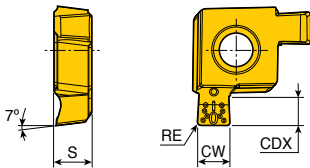

Size	Dimension (mm)			
	CW	CDX	S	RE
05	2.0	1.8	2.27	0.2
06	2.0	2.0	2.62	0.2
07	2.5	2.0	3.42	0.2
08	2.5	2.5	3.50	0.2
10	3.0	3.0	4.37	0.3
13	3.5	3.5	5.24	0.3
17	4.0	4.0	6.06	0.4

• For grooving

Insert	Designation	Coated						Uncoated	
		TT9080	TT8020	TT9300	TT9030	TT6030	TT7400	K10	
	XCMT 05R-200020GV	•	•						
	06R-200020GV	•	•						
	07R-250020GV	•	•						
	08R-250020GV	•	•						
	10R-300030GV	•	•						
	13R-350030GV	•	•						
17R-400040GV	•	•							



• Grooving insert is available only for right handed type

• Standard items

NPMX...R-B/R-G



Inserts for TBTA...3/5/7/9

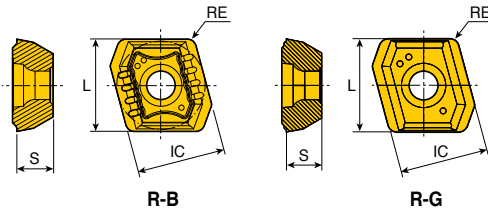

Size	Dimension (mm)			
	IC	L	S	RE
08	8.0	8.36	3.18	0.8

Insert	Designation	Pocket			Coated						Uncoated		
		Center	Inner	Outer	TT9030	TT8125	TT7200	TT6130	TT6020	TT5100	TT5030	K10	
	NPMX 080308R-B	●	●	●	●	●		●					
	080308R-G	●	●	●	●	●			●	●			



●: Standard items

TPMX...R-B/R-G



Inserts for TBTA...3/5/7/9 & TBTA-R

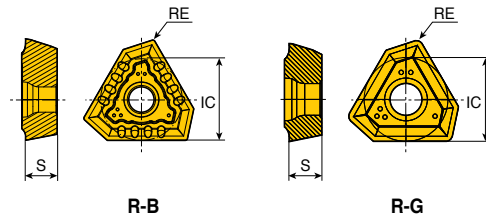

Size	Dimension (mm)			
	IC	S	RE	
140304 R-B	8.45	3.5	0.4	
140308 R-B/R-G	8.45	3.5	0.8	
170404 R-B	10.30	4.0	0.4	
170408 R-B/R-G	10.30	4.0	0.8	
240504 R-B	14.20	5.5	0.4	
240512 R-B/R-G	14.20	5.5	1.2	
280708 R-B	17.00	7.5	0.8	
280716 R-B/R-G	17.00	7.5	1.6	

Insert	Designation	Pocket			Coated						Uncoated		
		Center	Inner	Outer	TT9030	TT9130	TT8125	TT7200	TT6130	TT6020	TT5100	TT5030	K10
	TPMX 140304R-B	●	●	●	●		●		●				
	140308R-B	●	●	●		●					●		
	140308R-G	●	●	●	●	●	●			●	●	●	
	170404R-B	●	●	●	●		●		●				
	170408R-B	●	●	●		●						●	
	170408R-G	●	●	●	●	●	●			●	●	●	
	240504R-B	●	●	●	●				●				
	240512R-B	●	●	●		●						●	
	240512R-G	●	●	●	●	●	●			●	●	●	
	280708R-B	●	●	●	●	●			●				
280716R-B	●	●	●		●						●		
280716R-G	●	●	●	●	●	●	●		●	●	●		



●: Standard items

TPMX...LG



Inserts for TBTA-R

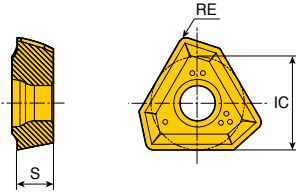

Size	Dimension (mm)		
	IC	S	RE
14	8.45	3.5	0.8
17	10.30	4.0	0.8
24	14.20	5.5	1.2

Insert	Designation	Pocket			Coated						Uncoated			
		Center	Inner	Outer	TT9030	TT9130	TT8125	TT7200	TT6130	TT6020	TT5100	TT5030	K10	
	TPMX 140308 LG			•	•						•			
	170408 LG			•	•	•				•	•			
	240512 LG			•	•	•				•	•			



•: Standard items

XPMT...-45



Inserts for TBTA-R

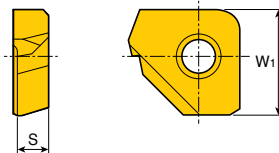

Size	Dimension (mm)	
	W1	S
16	9.5	2.70

Insert	Designation	Pocket			Coated						Uncoated		
		Center	Inner	Outer	TT9030	TT8125	TT7100	TT3500	TT6020	TT9300	TT7400	K10	
	XPMT 16002-45			•	•								



•: Standard items

Pad for TBTA 3.../5.../7.../9...

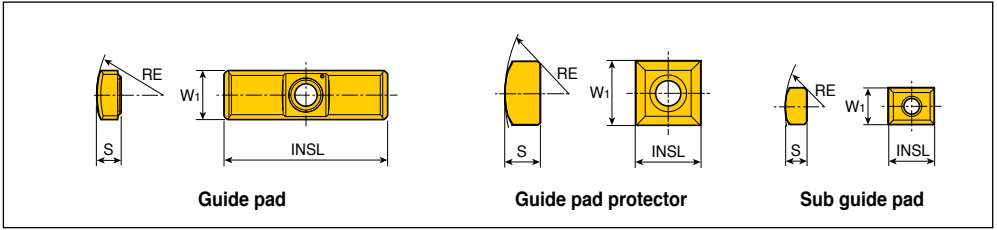

Designation		Dimension (mm)				Screw
		W ₁	S	INSL	RE	
Guide pad	PAD - GP08-25-155-DC-SB	8	4.5	25	15.5	CSTB3S
	GP08-25-155-DC-SC	8	4.5	25	15.5	CSTB3S
	GP10-35-200-DC-SB	10	6.0	35	20.0	CSTB4S
	GP10-35-200-DC-SC	10	6.0	35	20.0	CSTB4S
	GP14-40-250-DC-SB/SC	14	7.5	40	25.0	CSTA5S
	GP18-40-300-DC-SB/SC	18	9.0	40	30.0	LS1206S
Guide pad protector	PAD - P08	8	4.5	8	17.5	CSTB3S
	P10	10	6.0	10	20.0	CSTB4S
	P14	14	7.5	14	25.0	CSTA5S
	P18	18	9.0	18	30.0	LS1206S
	PAD - S08	8	4.5	10	17.5	CSTB3S
Sub guide pad	S10	10	5.0	10	29.0	CSTB3S
	S14	14	7.0	20	45.0	CCSTA5S



Plus Guide Pad for TBTA 3.../5.../7.../9...

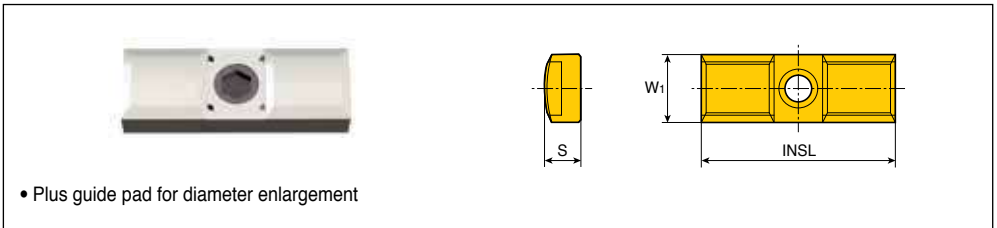

Designation										
DC	DC+1mm	S	DC+2mm	S	DC+3mm	S	DC+4mm	S	DC+5mm	S
PAD-GC08	PAD-GC08+1	5.0	PAD-GC08+2	5.5	PAD-GC08+3	6.0	-	-	-	-
PAD-GC10	PAD-GC10+1	6.5	PAD-GC10+2	7.0	PAD-GC10+3	7.5	PAD-GC10+4	8.0	-	-
PAD-GC14	PAD-GC14+1	8.0	PAD-GC14+2	8.5	PAD-GC14+3	9.0	PAD-GC14+4	9.5	PAD-GC14+5	10.0
PAD-GC18	PAD-GC18+1	9.5	PAD-GC18+2	10	PAD-GC18+3	10.5	PAD-GC18+4	11.0	PAD-GC18+5	11.5



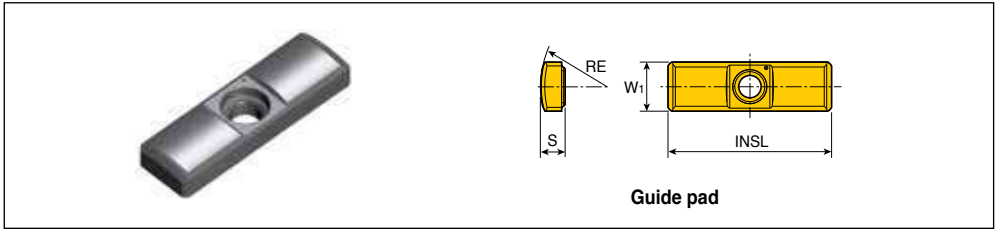

Designation	Dimension (mm)				Screw	
	W1	S	INSL	RE		
Guide pad	PAD - GP06-20-120-DC-SB	6	3.0	20	12.0	CSTB2.2S
	GP06-20-120-DC-SC	6	3.0	20	12.0	CSTB2.2S
	GP07-20-120-DC-SB	7	3.5	20	12.0	CSTB3S
	GP07-20-120-DC-SC	7	3.5	20	12.0	CSTB3S
	GP08-25-155-DC-SB	8	4.5	25	15.5	CSTB3S
	GP08-25-155-DC-SC	8	4.5	25	15.5	CSTB3S
	GP10-30-200-DC-SB	10	4.5	30	20.0	CSTB3.5
	GP10-30-200-DC-SC	10	4.5	30	20.0	CSTB3.5
	GP12-35-250-DC-SB	12	5.5	35	25.0	CSTB3.5
	GP12-35-250-DC-SC	12	5.5	35	25.0	CSTB3.5



Pad for TBTA-TR & TRGD

Solid carbide guide pads

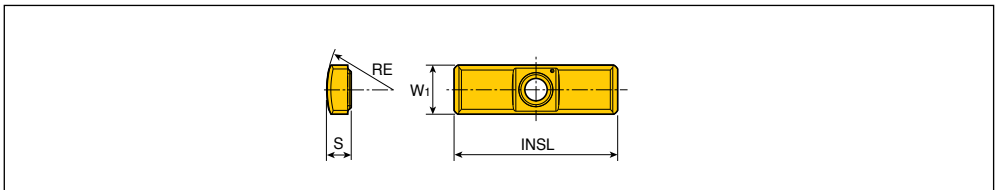

Designation	Dimension (mm)				Screw	
	W1	S	INSL	RE		
Guide pad	PAD - GP05-18-060-DC-SB	5	2.5	18	6.0	SR34-508
	GP05-18-060-DC-SC	5	2.5	18	6.0	SR34-508
	GP05-18-075-DC-SB	5	2.5	18	7.5	SR34-508
	GP05-18-075-DC-SC	5	2.5	18	7.5	SR34-508
	GP06-20-085-DC-SB	6	3.0	20	8.5	CSTB2.2S* / SR34-508
	GP06-20-085-DC-SC	6	3.0	20	8.5	CSTB2.2S* / SR34-508
	GP06-20-100-DC-SB	6	3.0	20	10.0	CSTB2.2S* / SR34-508
	GP06-20-100-DC-SC	6	3.0	20	10.0	CSTB2.2S* / SR34-508
	GP06-20-120-DC-SB	6	3.0	20	12.0	CSTB2.2S* / SR34-508
	GP06-20-120-DC-SC	6	3.0	20	12.0	CSTB2.2S* / SR34-508



- Guide pad with "SB" is the first choice in general purpose machining.
- "SC" is an excellent toughness grade used with water-soluble coolant.

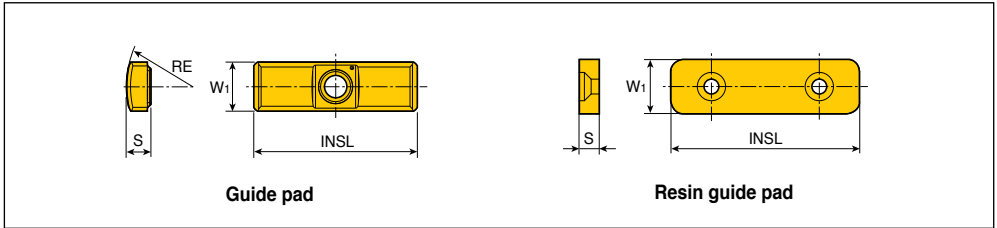

	Designation	Dimension (mm)				Screw
		W1	S	INSL	RE	
Guide pad	PAD - GC08-120	8	4.4	25	17.5	CSTB3S
	GC08-140	8	3.5	25	17.5	CSTB3S
	GP08-25-155-DC-SB	8	4.5	25	15.5	CSTB3S
	GP08-25-155-DC-SC	8	4.5	25	15.5	CSTB3S
	GP10-35-200-DC-SB	10	6.0	35	20.0	CSTB4S
	GP10-35-200-DC-SC	10	6.0	35	20.0	CSTB4S
	GP14-40-250-DC-SB	14	7.5	40	25.0	CSTA5S
	GP14-40-250-DC-SC	14	7.5	40	25.0	CSTA5S
	GP18-40-300-DC-SB	18	9.0	40	30.0	LS1206S
	GP18-40-300-DC-SC	18	9.0	40	30.0	LS1206S
Resin guide pad	PAD - R10	10	4.0	40	-	LS0902.5-6
	R12	12	5.0	45	-	LS0903-8
	R15	15	5.8	50	-	LS0904-10
	R20	20	7.5	70	-	LS0905-12
	R30	30	12.5	80	-	LS0906-15
	R35	35	15.5	100	-	LS0906-15



Cartridge for TBTA 3.../5.../7.../9

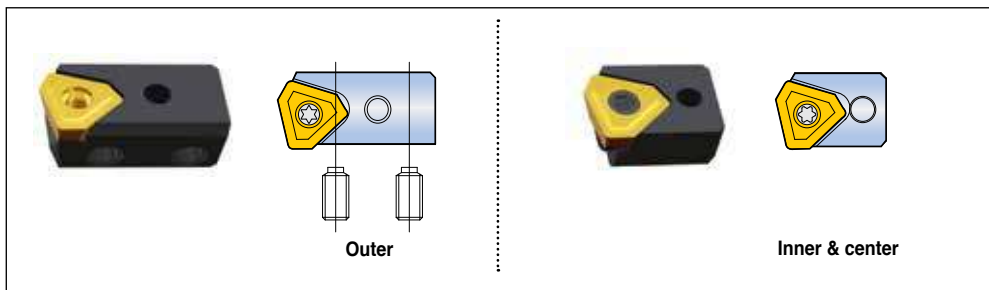

	Designation	Adjust screw	Wrench	Lock screw	Wrench	Insert
Outer	PERC 05R	AS0003-5	H1.5	LS1803RH	H2	NPMX0803..
	402-04	AS0004-8	H2	LS1803.5RH	H2.5	TPMX1403..
	402-32	AS0005-10	H2.5	LS1805RH	H3	TPMX1704..
	402-43	AS0005-15	H2.5	L1806RH	H4	TPMX2405..
	402-63	AS0006-15	H3	L1806RH	H4	TPMX2807..
Inner & center	CENC 05R	-	-	CSTB3	T9	NPMX0803..
	402-04	-	-	CSTB3.5	T15	TPMX1403..
	402-32	-	-	CSTA5	T15	TPMX1704..
	402-43	-	-	LS1206	H3	TPMX2405..
	402-63	-	-	LS1206	H3	TPMX2807..



Plus Cartridge for TBTA 3.../5.../7.../9



Designation					
DC	DC+1mm	DC+2mm	DC+3mm	DC+4mm	DC+5mm
PERC 05R	PERC 05R+1	PERC 05R+2	-	-	-
PERC 402-04	PERC 402-04+1	PERC 402-04+2	PERC 402-04+3	-	-
PERC 402-32	PERC 402-32+1	PERC 402-32+2	PERC 402-32+3	PERC 402-32+4	-
PERC 402-43	PERC 402-43+1	PERC 402-43+2	PERC 402-43+3	PERC 402-43+4	PERC 402-43+5
PERC 402-63	PERC 402-63+1	PERC 402-63+2	PERC 402-63+3	PERC 402-63+4	PERC 402-63+5



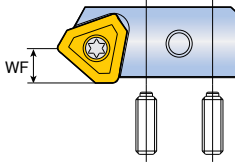

Accurate tolerance applications

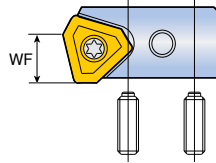

Open tolerance applications

Designation		WF (mm)	Adjust screw	Wrench	Lock screw	Wrench	Insert
Accurate tolerance applications	PERC P04R	5	AS0004-8	H2	LS1803.5RH	H2.5	TPMX1403..LG
	P32R	6	AS0005-10	H2.5	LS1805RH	H3	TPMX1704..LG
	P43R	8	AS0005-15	H2.5	LS1806RH	H4	TPMX2405..LG
Open tolerance applications	PERC 402-04	8	AS0004-8	H2	LS1803.5RH	H2.5	TPMX1403..RG
	402-32	9	AS0005-10	H2.5	LS1805RH	H3	TPMX1704..RG
	402-43	13	AS0005-15	H2.5	LS1806RH	H4	TPMX2405..RG



• PERC-P and PERC 402-□□ cartridges are interchangeable in the same pocket

Guide pad for TNDH-TP

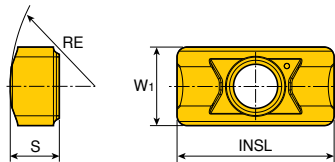

Designation	Dimension (mm)				Screw	Grade TT9030
	W1	S	INSL	RE		
PAD-G04-08	4	2.5	8	9	TS 20043I/HG-P	●



• Guide pad is sold separately from drill body.

• Standard items

Recommended Cutting Conditions

Machining data for TOP-DRILL 2,3,4xD

ISO	Material	Condition	Tensile strength (N/mm ²)	Hardness HB	Material No.	Cutting speed Vc (m/min)	
P	Non-alloy steel, cast steel, free cutting steel	<0.25%C	Annealed	420	125	1	220-350
		>=0.25%C	Annealed	650	190	2	180-280
		<0.55%C	Quenched and tempered	850	250	3	140-240
		>=0.55%C	Annealed	750	220	4	140-240
			Quenched and tempered	1000	300	5	140-240
	Low alloy steel and cast steel (Less than 5% of alloying elements)	Quenched and tempered	Annealed	600	200	6	140-240
				930	275	7	100-180
				1000	300	8	100-180
				1200	350	9	100-180
	High alloy steel, cast steel and tool steel	Annealed	680	200	10	140-200	
		Quenched and tempered	1100	325	11	100-160	
M	Stainless steel and cast steel	Ferritic / martensitic	680	200	12	150-250	
		Martensitic	820	240	13	150-250	
		Austenitic	600	180	14	150-250	
K	Gray cast iron (GG)	Ferritic		160	15	160-260	
		Pearlitic		250	16	160-260	
	Cast iron nodular (GGG)	Ferritic		180	17	160-260	
		Pearlitic		260	18	160-260	
	Malleable cast iron	Ferritic		130	19	120-220	
Pearlitic			230	20	120-220		
N	Aluminum - Wrought alloy	Not cureable		60	21	200-350	
		Cured		100	22	200-350	
	Aluminum-cast, alloyed	<=12% Si	Not cureable		75	23	200-350
			Cured		90	24	200-350
		>12% Si	High temp.		130	25	200-350
	Copper alloys	>1% Pb	Free cutting		110	26	150-250
			Brass		90	27	150-250
			Electrolitic copper		100	28	150-250
	Non-metallic		Duroplastics, fiber plastics			29	150-250
			Hard rubber			30	150-250
S	High temp. alloys	Fe based	Annealed		200	31	30-60
			Cured		280	32	30-60
		Ni or Co based	Annealed		250	33	30-60
			Cured		350	34	30-60
			Cast		320	35	30-60
	Titanium, Ti alloys		Rm 400		36	50-80	
			Alpha+beta alloys cured	Rm 1050		37	50-80
H	Hardened steel	Hardened		55HRC	38	30-60	
		Hardened		60HRC	39	30-60	
	Chilled cast iron	Cast		400	40	30-60	
	Cast iron nodular	Hardened		55HRC	41	30-60	

• For more information of material groups, see the materials & grades "material conversion table"

■ Steel
 ■ Stainless steel
 ■ Cast iron
 ■ Nonferrous
 ■ High temp. alloys
 ■ Hardened steel

Recommended Cutting Conditions



Machining data for TOP-DRILL 2,3,4xD

Feed (mm/rev) vs. drill diameter Drill length 2,3,4xD								
SOMT 04 Ø12 - Ø13.5	SOMT 05 Ø14 - Ø16	SOMT 06 Ø17 - Ø19	SOMT 07 Ø20 - Ø22	SOMT 08 Ø23 - Ø26	SOMT 09 Ø27 - Ø31	SOMT 11 Ø32 - Ø36	SOMT 13 Ø37 - Ø43	SOMT 15 Ø44 - Ø50
0.04-0.06	0.04-0.06	0.04-0.06	0.04-0.08	0.04-0.08	0.06-0.10	0.06-0.10	0.08-0.12	0.08-0.12
0.06-0.10	0.06-0.10	0.06-0.10	0.06-0.12	0.06-0.12	0.08-0.14	0.08-0.14	0.08-0.16	0.10-0.16
0.08-0.12	0.08-0.12	0.08-0.12	0.08-0.16	0.08-0.16	0.10-0.16	0.10-0.16	0.10-0.18	0.10-0.18
0.08-0.12	0.08-0.12	0.08-0.12	0.08-0.16	0.08-0.16	0.10-0.16	0.10-0.16	0.10-0.18	0.10-0.18
0.08-0.12	0.08-0.12	0.08-0.12	0.08-0.16	0.08-0.16	0.10-0.16	0.10-0.16	0.10-0.18	0.10-0.18
0.06-0.16	0.06-0.16	0.06-0.16	0.08-0.20	0.08-0.20	0.08-0.20	0.10-0.22	0.10-0.22	0.10-0.24
0.06-0.16	0.06-0.16	0.06-0.16	0.08-0.20	0.08-0.20	0.08-0.20	0.08-0.22	0.10-0.22	0.10-0.22
0.06-0.16	0.06-0.16	0.06-0.16	0.08-0.20	0.08-0.20	0.08-0.20	0.08-0.22	0.10-0.22	0.10-0.22
0.06-0.16	0.06-0.16	0.06-0.16	0.08-0.20	0.08-0.20	0.08-0.20	0.08-0.22	0.10-0.22	0.10-0.22
0.06-0.12	0.06-0.12	0.06-0.12	0.08-0.16	0.08-0.16	0.08-0.18	0.08-0.20	0.10-0.20	0.10-0.20
0.06-0.12	0.06-0.12	0.06-0.12	0.08-0.16	0.08-0.16	0.08-0.18	0.08-0.20	0.10-0.20	0.10-0.20
0.06-0.12	0.06-0.12	0.06-0.12	0.06-0.16	0.06-0.16	0.08-0.18	0.08-0.20	0.10-0.20	0.10-0.20
0.06-0.12	0.06-0.12	0.06-0.12	0.06-0.16	0.06-0.16	0.08-0.18	0.08-0.20	0.10-0.20	0.10-0.20
0.06-0.12	0.06-0.12	0.06-0.12	0.06-0.16	0.06-0.16	0.08-0.18	0.08-0.20	0.10-0.20	0.10-0.20
0.08-0.18	0.08-0.18	0.08-0.18	0.10-0.20	0.10-0.20	0.10-0.20	0.10-0.20	0.10-0.22	0.10-0.22
0.08-0.18	0.08-0.18	0.08-0.18	0.10-0.20	0.10-0.20	0.10-0.20	0.10-0.20	0.10-0.22	0.10-0.22
0.08-0.18	0.08-0.18	0.08-0.18	0.10-0.20	0.10-0.20	0.10-0.20	0.10-0.20	0.10-0.22	0.10-0.22
0.08-0.18	0.08-0.18	0.08-0.18	0.10-0.20	0.10-0.20	0.10-0.20	0.10-0.20	0.10-0.22	0.10-0.22
0.08-0.14	0.08-0.14	0.08-0.14	0.10-0.16	0.10-0.16	0.10-0.16	0.10-0.18	0.10-0.18	0.10-0.18
0.08-0.14	0.08-0.14	0.08-0.14	0.10-0.16	0.10-0.16	0.10-0.16	0.10-0.18	0.10-0.18	0.10-0.18
0.06-0.15	0.06-0.15	0.06-0.15	0.08-0.16	0.08-0.16	0.08-0.18	0.08-0.18	0.10-0.18	0.10-0.18
0.06-0.15	0.06-0.15	0.06-0.15	0.08-0.16	0.08-0.16	0.08-0.18	0.08-0.18	0.10-0.18	0.10-0.18
0.06-0.15	0.06-0.15	0.06-0.15	0.08-0.16	0.08-0.16	0.08-0.18	0.08-0.18	0.10-0.18	0.10-0.18
0.06-0.15	0.06-0.15	0.06-0.15	0.08-0.16	0.08-0.16	0.08-0.18	0.08-0.18	0.10-0.18	0.10-0.18
0.06-0.15	0.06-0.15	0.06-0.15	0.08-0.16	0.08-0.16	0.08-0.16	0.08-0.17	0.10-0.18	0.10-0.18
0.06-0.15	0.06-0.15	0.06-0.15	0.08-0.16	0.08-0.16	0.08-0.16	0.08-0.17	0.10-0.18	0.10-0.18
0.06-0.15	0.06-0.15	0.06-0.15	0.08-0.16	0.08-0.16	0.08-0.16	0.08-0.17	0.10-0.18	0.10-0.18
0.06-0.15	0.06-0.15	0.06-0.15	0.08-0.16	0.08-0.16	0.10-0.17	0.10-0.17	0.10-0.18	0.10-0.18
0.06-0.15	0.06-0.15	0.06-0.15	0.08-0.16	0.08-0.16	0.10-0.17	0.10-0.17	0.10-0.18	0.10-0.18
0.05-0.08	0.05-0.08	0.05-0.08	0.05-0.09	0.05-0.09	0.06-0.10	0.06-0.10	0.06-0.12	0.06-0.12
0.05-0.08	0.05-0.08	0.05-0.08	0.05-0.09	0.05-0.09	0.06-0.10	0.06-0.10	0.06-0.12	0.06-0.12
0.05-0.08	0.05-0.08	0.05-0.08	0.05-0.09	0.05-0.09	0.06-0.10	0.06-0.10	0.06-0.12	0.06-0.12
0.05-0.08	0.05-0.08	0.05-0.08	0.05-0.09	0.05-0.09	0.06-0.10	0.06-0.10	0.06-0.12	0.06-0.12
0.06-0.09	0.06-0.09	0.06-0.09	0.06-0.10	0.06-0.10	0.06-0.10	0.06-0.10	0.06-0.10	0.06-0.10
0.06-0.09	0.06-0.09	0.06-0.09	0.06-0.10	0.06-0.10	0.06-0.10	0.06-0.10	0.06-0.10	0.06-0.10
0.05-0.09	0.05-0.09	0.05-0.09	0.05-0.10	0.05-0.10	0.05-0.10	0.05-0.10	0.05-0.10	0.05-0.10
0.05-0.09	0.05-0.09	0.05-0.09	0.05-0.10	0.05-0.10	0.05-0.10	0.05-0.10	0.05-0.10	0.05-0.10
0.05-0.09	0.05-0.09	0.05-0.09	0.05-0.10	0.05-0.10	0.05-0.10	0.05-0.10	0.05-0.10	0.05-0.10
0.05-0.09	0.05-0.09	0.05-0.09	0.05-0.10	0.05-0.10	0.05-0.10	0.05-0.10	0.05-0.10	0.05-0.10

Recommended Cutting Conditions

Machining data for TOP-DRILL 5xD

ISO	Material	Condition	Tensile strength (N/mm ²)	Hardness HB	Material No.	Cutting speed Vc (m/min)		
P	Non-alloy steel, cast steel, free cutting steel	<0.25%C	Annealed	420	125	1	220-350	
		>=0.25%C	Annealed	650	190	2	180-280	
		<0.55%C	Quenched and tempered	850	250	3	140-240	
		>=0.55%C	Annealed	750	220	4	140-240	
			Quenched and tempered	1000	300	5	140-240	
	Low alloy steel and cast steel (Less than 5% of alloying elements)		Annealed		600	200	6	140-240
					930	275	7	100-180
			Quenched and tempered		1000	300	8	100-180
					1200	350	9	100-180
	High alloy steel, cast steel and tool steel		Annealed	680	200	10	140-200	
			Quenched and tempered	1100	325	11	100-160	
M	Stainless steel and cast steel	Ferritic / martensitic	680	200	12	150-250		
		Martensitic	820	240	13	150-250		
		Austenitic	600	180	14	150-250		
K	Gray cast iron (GG)	Ferritic		160	15	160-260		
		Pearlitic		250	16	160-260		
	Cast iron nodular (GGG)	Ferritic		180	17	160-260		
		Pearlitic		260	18	160-260		
	Malleable cast iron	Ferritic		130	19	120-220		
Pearlitic			230	20	120-220			
N	Aluminum - Wrought alloy	Not cureable		60	21	200-350		
		Cured		100	22	200-350		
	Aluminum-cast, alloyed	<=12% Si	Not cureable		75	23	200-350	
			Cured		90	24	200-350	
		>12% Si	High temp.		130	25	200-350	
	Copper alloys		>1% Pb	Free cutting		110	26	150-250
				Brass		90	27	150-250
				Electrolytic copper		100	28	150-250
	Non-metallic		Duroplastics, fiber plastics			29	150-250	
			Hard rubber			30	150-250	
S	High temp. alloys	Fe based	Annealed		200	31	30-60	
			Cured		280	32	30-60	
		Ni or Co based	Annealed		250	33	30-60	
			Cured		350	34	30-60	
			Cast		320	35	30-60	
	Titanium, Ti alloys			Rm 400		36	50-80	
			Alpha+beta alloys cured	Rm 1050		37	50-80	
H	Hardened steel	Hardened		55HRC	38	30-60		
		Hardened		60HRC	39	30-60		
	Chilled cast iron	Cast		400	40	30-60		
	Cast iron nodular	Hardened		55HRC	41	30-60		

• For more information of material groups, see the materials & grades "material conversion table"

■ Steel
 ■ Stainless steel
 ■ Cast iron
 ■ Nonferrous
 ■ High temp. alloys
 ■ Hardened steel

Recommended Cutting Conditions



Machining data for TOP-DRILL 5xD

Feed (mm/rev) vs. drill diameter Drill length 5xD								
SOMT 04 Ø12 - Ø13.5	SOMT 05 Ø14 - Ø16	SOMT 06 Ø17 - Ø19	SOMT 07 Ø20 - Ø22	SOMT 08 Ø23 - Ø26	SOMT 09 Ø27 - Ø31	SOMT 11 Ø32 - Ø36	SOMT 13 Ø37 - Ø43	SOMT 15 Ø44 - Ø50
0.04-0.05	0.04-0.05	0.04-0.05	0.04-0.05	0.04-0.06	0.06-0.08	0.06-0.08	0.08-0.10	0.08-0.10
0.06-0.08	0.06-0.08	0.06-0.08	0.06-0.10	0.06-0.10	0.08-0.12	0.08-0.12	0.08-0.14	0.10-0.14
0.06-0.10	0.06-0.10	0.06-0.10	0.06-0.12	0.06-0.12	0.10-0.15	0.10-0.15	0.10-0.17	0.10-0.17
0.06-0.10	0.06-0.10	0.06-0.10	0.06-0.12	0.06-0.12	0.10-0.15	0.10-0.15	0.10-0.17	0.10-0.17
0.06-0.10	0.06-0.10	0.06-0.10	0.06-0.12	0.06-0.12	0.10-0.15	0.10-0.15	0.10-0.17	0.10-0.17
0.06-0.12	0.06-0.12	0.06-0.12	0.08-0.16	0.08-0.16	0.08-0.18	0.10-0.20	0.10-0.20	0.10-0.22
0.06-0.12	0.06-0.12	0.06-0.12	0.08-0.16	0.08-0.16	0.08-0.18	0.10-0.20	0.10-0.20	0.10-0.22
0.06-0.12	0.06-0.12	0.06-0.12	0.08-0.16	0.08-0.16	0.08-0.18	0.10-0.20	0.10-0.20	0.10-0.22
0.06-0.12	0.06-0.12	0.06-0.12	0.08-0.16	0.08-0.16	0.08-0.18	0.10-0.20	0.10-0.20	0.10-0.22
0.06-0.10	0.06-0.10	0.06-0.10	0.08-0.12	0.08-0.12	0.08-0.16	0.08-0.18	0.10-0.18	0.10-0.20
0.06-0.10	0.06-0.10	0.06-0.10	0.08-0.12	0.08-0.12	0.08-0.16	0.08-0.18	0.10-0.18	0.10-0.20
0.06-0.10	0.06-0.10	0.06-0.10	0.06-0.12	0.06-0.12	0.08-0.16	0.08-0.18	0.10-0.18	0.10-0.20
0.06-0.10	0.06-0.10	0.06-0.10	0.06-0.12	0.06-0.12	0.08-0.16	0.08-0.18	0.10-0.18	0.10-0.20
0.06-0.10	0.06-0.10	0.06-0.10	0.06-0.12	0.06-0.12	0.08-0.16	0.08-0.18	0.10-0.18	0.10-0.20
0.08-0.14	0.08-0.14	0.08-0.14	0.08-0.16	0.08-0.16	0.10-0.18	0.10-0.18	0.10-0.20	0.10-0.20
0.08-0.14	0.08-0.14	0.08-0.14	0.08-0.16	0.08-0.16	0.10-0.18	0.10-0.18	0.10-0.20	0.10-0.20
0.08-0.14	0.08-0.14	0.08-0.14	0.08-0.16	0.08-0.16	0.10-0.18	0.10-0.18	0.10-0.20	0.10-0.20
0.08-0.14	0.08-0.14	0.08-0.14	0.08-0.16	0.08-0.16	0.10-0.18	0.10-0.18	0.10-0.20	0.10-0.20
0.08-0.12	0.08-0.12	0.08-0.14	0.08-0.16	0.08-0.16	0.10-0.16	0.10-0.16	0.10-0.16	0.10-0.16
0.08-0.12	0.08-0.12	0.08-0.14	0.08-0.16	0.08-0.16	0.10-0.16	0.10-0.16	0.10-0.16	0.10-0.16
0.06-0.15	0.06-0.15	0.06-0.15	0.08-0.16	0.08-0.16	0.08-0.16	0.08-0.16	0.10-0.17	0.10-0.17
0.06-0.15	0.06-0.15	0.06-0.15	0.08-0.16	0.08-0.16	0.08-0.16	0.08-0.16	0.10-0.17	0.10-0.17
0.06-0.15	0.06-0.15	0.06-0.15	0.08-0.16	0.08-0.16	0.08-0.16	0.08-0.16	0.10-0.17	0.10-0.17
0.06-0.15	0.06-0.15	0.06-0.15	0.08-0.16	0.08-0.16	0.08-0.16	0.08-0.16	0.10-0.17	0.10-0.17
0.06-0.15	0.06-0.15	0.06-0.15	0.08-0.16	0.08-0.16	0.08-0.16	0.08-0.16	0.10-0.17	0.10-0.17
0.06-0.15	0.06-0.15	0.06-0.15	0.08-0.16	0.08-0.16	0.08-0.15	0.08-0.16	0.10-0.17	0.10-0.17
0.06-0.15	0.06-0.15	0.06-0.15	0.08-0.16	0.08-0.16	0.08-0.15	0.08-0.16	0.10-0.17	0.10-0.17
0.06-0.15	0.06-0.15	0.06-0.15	0.08-0.16	0.08-0.16	0.08-0.15	0.08-0.16	0.10-0.17	0.10-0.17
0.06-0.15	0.06-0.15	0.06-0.15	0.08-0.16	0.08-0.16	0.10-0.16	0.10-0.16	0.10-0.17	0.10-0.17
0.06-0.15	0.06-0.15	0.06-0.15	0.08-0.16	0.08-0.16	0.10-0.16	0.10-0.16	0.10-0.17	0.10-0.17
0.05-0.07	0.05-0.07	0.05-0.08	0.05-0.08	0.05-0.08	0.06-0.09	0.06-0.09	0.06-0.10	0.06-0.10
0.05-0.07	0.05-0.07	0.05-0.08	0.05-0.08	0.05-0.08	0.06-0.09	0.06-0.09	0.06-0.10	0.06-0.10
0.05-0.07	0.05-0.07	0.05-0.08	0.05-0.08	0.05-0.08	0.06-0.09	0.06-0.09	0.06-0.10	0.06-0.10
0.05-0.07	0.05-0.07	0.05-0.08	0.05-0.08	0.05-0.08	0.06-0.09	0.06-0.09	0.06-0.10	0.06-0.10
0.05-0.08	0.05-0.08	0.05-0.08	0.06-0.09	0.06-0.09	0.06-0.10	0.06-0.10	0.06-0.10	0.06-0.10
0.05-0.08	0.05-0.08	0.05-0.08	0.06-0.09	0.06-0.09	0.06-0.10	0.06-0.10	0.06-0.10	0.06-0.10
0.05-0.08	0.05-0.08	0.05-0.08	0.05-0.09	0.05-0.09	0.05-0.10	0.05-0.10	0.05-0.10	0.05-0.10
0.05-0.08	0.05-0.08	0.05-0.08	0.05-0.09	0.05-0.09	0.05-0.10	0.05-0.10	0.05-0.10	0.05-0.10
0.05-0.08	0.05-0.08	0.05-0.08	0.05-0.09	0.05-0.09	0.05-0.10	0.05-0.10	0.05-0.10	0.05-0.10

Recommended Cutting Conditions

Machining data for TOP-DRILL cartridge

ISO	Material	Condition	Tensile strength (N/mm ²)	Hardness HB	Material No.	Cutting speed Vc (m/min)		
P	Non-alloy steel, cast steel, free cutting steel	<0.25%C	Annealed	420	125	1	250-350	
		>=0.25%C	Annealed	650	190	2	160-250	
		<0.55%C	Quenched and tempered	850	250	3	140-240	
		>=0.55%C	Annealed	750	220	4	140-240	
			Quenched and tempered	1000	300	5	140-240	
	Low alloy steel and cast steel (Less than 5% of alloying elements)		Annealed		600	200	6	140-240
					930	275	7	100-180
			Quenched and tempered		1000	300	8	100-180
					1200	350	9	100-180
	High alloy steel, cast steel and tool steel		Annealed	680	200	10	140-200	
			Quenched and tempered	1100	325	11	100-160	
M	Stainless steel and cast steel	Ferritic / martensitic	680	200	12	150-250		
		Martensitic	820	240	13	150-250		
		Austenitic	600	180	14	150-250		
K	Gray cast iron (GG)	Ferritic		160	15	160-260		
		Pearlitic		250	16	160-260		
	Cast iron nodular (GGG)	Ferritic		180	17	160-260		
		Pearlitic		260	18	160-260		
	Malleable cast iron	Ferritic		130	19	120-220		
Pearlitic			230	20	120-220			
N	Aluminum - Wrought alloy	Not cureable		60	21	200-350		
		Cured		100	22	200-350		
	Aluminum-cast, alloyed	<=12% Si	Not cureable		75	23	200-350	
			Cured		90	24	200-350	
		>12% Si	High temp.		130	25	200-350	
	Copper alloys	>1% Pb	Free cutting		110	26	150-250	
			Brass		90	27	150-250	
			Electrolitic copper		100	28	150-250	
	Non-metallic		Duroplastics, fiber plastics			29	150-250	
			Hard rubber			30	150-250	
S	High temp. alloys	Fe based	Annealed		200	31	30-60	
			Cured		280	32	30-60	
		Ni or Co based	Annealed		250	33	30-60	
			Cured		350	34	30-60	
			Cast		320	35	30-60	
	Titanium, Ti alloys			Rm 400		36	50-80	
			Alpha+beta alloys cured	Rm 1050		37	50-80	
H	Hardened steel	Hardened		55HRC	38	30-60		
		Hardened		60HRC	39	30-60		
	Chilled cast iron	Cast		400	40	30-60		
	Cast iron nodular	Hardened		55HRC	41	30-60		

• For more information of material groups, see the materials & grades "material conversion table"

■ Steel
 ■ Stainless steel
 ■ Cast iron
 ■ Nonferrous
 ■ High temp. alloys
 ■ Hardened steel

Recommended Cutting Conditions



Machining data for TOP-DRILL cartridge

Feed (mm/rev) vs. drill diameter Drill length 2,3,4xD					
SOMT 09 Ø51 - Ø55	SOMT 11 Ø56 - Ø60	SOMT 11 Ø61 - Ø65	SOMT 11 Ø66 - Ø70	SOMT 13 Ø71 - Ø75	SOMT 13 Ø76 - Ø80
0.06-0.12	0.06-0.12	0.06-0.12	0.06-0.12	0.06-0.12	0.06-0.12
0.06-0.16	0.06-0.16	0.06-0.16	0.06-0.16	0.06-0.16	0.06-0.16
0.08-0.18	0.08-0.18	0.08-0.18	0.08-0.18	0.08-0.18	0.08-0.18
0.08-0.18	0.08-0.18	0.08-0.18	0.08-0.18	0.08-0.18	0.08-0.18
0.08-0.18	0.08-0.18	0.08-0.18	0.08-0.18	0.08-0.18	0.08-0.18
0.08-0.20	0.08-0.20	0.08-0.20	0.08-0.20	0.08-0.20	0.08-0.20
0.08-0.20	0.08-0.20	0.08-0.20	0.08-0.20	0.08-0.20	0.08-0.20
0.08-0.20	0.08-0.20	0.08-0.20	0.08-0.20	0.08-0.20	0.08-0.20
0.08-0.20	0.08-0.20	0.08-0.20	0.08-0.20	0.08-0.20	0.08-0.20
0.08-0.20	0.08-0.20	0.08-0.20	0.08-0.20	0.08-0.20	0.08-0.20
0.08-0.18	0.08-0.18	0.08-0.18	0.08-0.18	0.08-0.18	0.08-0.18
0.08-0.18	0.08-0.18	0.08-0.18	0.08-0.18	0.08-0.18	0.08-0.18
0.08-0.18	0.08-0.18	0.08-0.18	0.08-0.18	0.08-0.18	0.08-0.18
0.08-0.18	0.08-0.18	0.08-0.18	0.08-0.18	0.08-0.18	0.08-0.18
0.10-0.22	0.10-0.22	0.10-0.22	0.10-0.22	0.10-0.22	0.10-0.22
0.10-0.22	0.10-0.22	0.10-0.22	0.10-0.22	0.10-0.22	0.10-0.22
0.10-0.22	0.10-0.22	0.10-0.22	0.10-0.22	0.10-0.22	0.10-0.22
0.10-0.22	0.10-0.22	0.10-0.22	0.10-0.22	0.10-0.22	0.10-0.22
0.10-0.18	0.10-0.18	0.10-0.18	0.10-0.18	0.10-0.18	0.10-0.18
0.10-0.18	0.10-0.18	0.10-0.18	0.10-0.18	0.10-0.18	0.10-0.18
0.06-0.18	0.06-0.18	0.06-0.18	0.06-0.18	0.06-0.18	0.06-0.18
0.06-0.18	0.06-0.18	0.06-0.18	0.06-0.18	0.06-0.18	0.06-0.18
0.06-0.18	0.06-0.18	0.06-0.18	0.06-0.18	0.06-0.18	0.06-0.18
0.06-0.18	0.06-0.18	0.06-0.18	0.06-0.18	0.06-0.18	0.06-0.18
0.06-0.18	0.06-0.18	0.06-0.18	0.06-0.18	0.06-0.18	0.06-0.18
0.10-0.18	0.10-0.18	0.10-0.18	0.10-0.18	0.10-0.18	0.10-0.18
0.10-0.18	0.10-0.18	0.10-0.18	0.10-0.18	0.10-0.18	0.10-0.18
0.10-0.18	0.10-0.18	0.10-0.18	0.10-0.18	0.10-0.18	0.10-0.18
0.10-0.18	0.10-0.18	0.10-0.18	0.10-0.18	0.10-0.18	0.10-0.18
0.10-0.18	0.10-0.18	0.10-0.18	0.10-0.18	0.10-0.18	0.10-0.18
0.06-0.10	0.06-0.10	0.06-0.10	0.06-0.10	0.06-0.10	0.06-0.10
0.06-0.10	0.06-0.10	0.06-0.10	0.06-0.10	0.06-0.10	0.06-0.10
0.06-0.10	0.06-0.10	0.06-0.10	0.06-0.10	0.06-0.10	0.06-0.10
0.06-0.10	0.06-0.10	0.06-0.10	0.06-0.10	0.06-0.10	0.06-0.10
0.06-0.10	0.06-0.10	0.06-0.10	0.06-0.10	0.06-0.10	0.06-0.10
0.06-0.10	0.06-0.10	0.06-0.10	0.06-0.10	0.06-0.10	0.06-0.10
0.05-0.10	0.05-0.10	0.05-0.10	0.05-0.10	0.05-0.10	0.05-0.10
0.05-0.10	0.05-0.10	0.05-0.10	0.05-0.10	0.05-0.10	0.05-0.10
0.05-0.10	0.05-0.10	0.05-0.10	0.05-0.10	0.05-0.10	0.05-0.10
0.05-0.10	0.05-0.10	0.05-0.10	0.05-0.10	0.05-0.10	0.05-0.10

Recommended Cutting Conditions



Machining data for T-DRILL 2,3,4xD

ISO	Material	Condition	Tensile strength (N/mm ²)	Hardness HB	Material No.	Cutting speed Vc (m/min)		
P	Non-alloy steel, cast steel, free cutting steel	<0.25%C	Annealed	420	125	1	250-350	
		>=0.25%C	Annealed	650	190	2	180-250	
		<0.55%C	Quenched and tempered	850	250	3	160-220	
		>=0.55%C	Annealed	750	220	4	160-220	
			Quenched and tempered	1000	300	5	160-220	
	Low alloy steel and cast steel (Less than 5% of alloying elements)		Annealed		600	200	6	150-220
					930	275	7	120-160
			Quenched and tempered		1000	300	8	120-160
					1200	350	9	120-160
	High alloy steel, cast steel and tool steel		Annealed	680	200	10	140-180	
			Quenched and tempered	1100	325	11	130-180	
M	Stainless steel and cast steel	Ferritic / martensitic	680	200	12	170-240		
		Martensitic	820	240	13	170-240		
		Austenitic	600	180	14	170-240		
K	Gray cast iron (GG)	Ferritic		160	15	180-250		
		Pearlitic		250	16	180-250		
	Cast iron nodular (GGG)	Ferritic		180	17	180-250		
		Pearlitic		260	18	180-250		
	Malleable cast iron	Ferritic		130	19	130-200		
Pearlitic			230	20	130-200			
N	Aluminum - Wrought alloy	Not cureable		60	21	330-380		
		Cured		100	22	330-380		
	Aluminum-cast, alloyed	<=12% Si	Not cureable		75	23	330-380	
			Cured		90	24	330-380	
		>12% Si	High temp.		130	25	330-380	
	Copper alloys	>1% Pb	Free cutting		110	26	150-230	
			Brass		90	27	150-230	
			Electrolitic copper		100	28	150-230	
	Non-metallic		Duroplastics, fiber plastics			29	150-230	
			Hard rubber			30	150-230	
S	High temp. alloys	Fe based	Annealed		200	31	30-60	
			Cured		280	32	30-60	
		Ni or Co based	Annealed		250	33	30-60	
			Cured		350	34	30-60	
			Cast		320	35	30-60	
	Titanium, Ti alloys			Rm 400		36	30-60	
		Alpha+beta alloys cured		Rm 1050		37	30-60	
H	Hardened steel	Hardened			55HRC	38	30-60	
		Hardened			60HRC	39	30-60	
	Chilled cast iron	Cast			400	40	30-60	
	Cast iron nodular	Hardened			55HRC	41	30-60	

• For more information of material groups, see the materials & grades "material conversion table"

■ Steel
 ■ Stainless steel
 ■ Cast iron
 ■ Nonferrous
 ■ High temp. alloys
 ■ Hardened steel

Recommended Cutting Conditions



Machining data for T-DRILL 2,3,4xD

Feed (mm/rev) vs. drill diameter Drill length 2,3,4xD					
SPMG 05 Ø12.5 - Ø15	SPMG 06 Ø16 - Ø21	SPMG 07 Ø22 - Ø27	SPMG 09 Ø28 - Ø33	SPMG 11 Ø34 - Ø41	SPMG 14 Ø42 - Ø50
0.04-0.06	0.04-0.06	0.04-0.08	0.04-0.08	0.06-0.10	0.06-0.12
0.05-0.08	0.06-0.10	0.06-0.12	0.07-0.13	0.08-0.15	0.08-0.16
0.06-0.12	0.08-0.15	0.10-0.18	0.12-0.22	0.12-0.24	0.13-0.25
0.06-0.12	0.08-0.15	0.10-0.18	0.12-0.22	0.12-0.24	0.13-0.25
0.06-0.12	0.08-0.14	0.10-0.18	0.12-0.20	0.12-0.20	0.13-0.20
0.06-0.15	0.06-0.15	0.08-0.18	0.08-0.18	0.08-0.18	0.08-0.18
0.06-0.15	0.06-0.15	0.08-0.18	0.08-0.18	0.08-0.18	0.08-0.18
0.06-0.15	0.06-0.15	0.08-0.18	0.08-0.18	0.08-0.18	0.08-0.18
0.06-0.10	0.06-0.10	0.08-0.12	0.08-0.14	0.08-0.14	0.08-0.14
0.06-0.10	0.08-0.12	0.10-0.15	0.12-0.15	0.12-0.18	0.13-0.18
0.05-0.10	0.06-0.12	0.08-0.15	0.09-0.16	0.10-0.17	0.11-0.18
0.05-0.10	0.06-0.12	0.08-0.15	0.09-0.16	0.10-0.17	0.11-0.18
0.05-0.10	0.06-0.12	0.08-0.15	0.09-0.16	0.10-0.17	0.11-0.18
0.06-0.12	0.08-0.16	0.12-0.20	0.15-0.25	0.16-0.28	0.18-0.30
0.06-0.12	0.08-0.16	0.12-0.20	0.15-0.25	0.16-0.28	0.18-0.30
0.06-0.12	0.08-0.16	0.12-0.20	0.15-0.25	0.16-0.28	0.18-0.30
0.06-0.12	0.08-0.16	0.12-0.20	0.15-0.25	0.16-0.28	0.18-0.30
0.06-0.10	0.08-0.15	0.10-0.18	0.12-0.20	0.15-0.23	0.16-0.25
0.06-0.10	0.08-0.15	0.10-0.18	0.12-0.20	0.15-0.23	0.16-0.25
0.06-0.14	0.08-0.15	0.10-0.20	0.12-0.22	0.14-0.23	0.15-0.26
0.06-0.14	0.08-0.15	0.10-0.20	0.12-0.22	0.14-0.23	0.15-0.26
0.06-0.14	0.08-0.15	0.10-0.20	0.12-0.22	0.14-0.23	0.15-0.26
0.06-0.14	0.08-0.15	0.10-0.20	0.12-0.22	0.14-0.23	0.15-0.26
0.06-0.13	0.06-0.13	0.08-0.15	0.08-0.15	0.08-0.15	0.08-0.15
0.06-0.13	0.06-0.13	0.08-0.15	0.08-0.15	0.08-0.15	0.08-0.15
0.06-0.13	0.06-0.13	0.08-0.15	0.08-0.15	0.08-0.15	0.08-0.15
0.06-0.13	0.06-0.13	0.08-0.15	0.08-0.15	0.08-0.15	0.08-0.15
0.05-0.08	0.05-0.08	0.05-0.09	0.05-0.09	0.05-0.09	0.05-0.09
0.05-0.08	0.05-0.08	0.05-0.09	0.05-0.09	0.05-0.09	0.05-0.09
0.05-0.08	0.05-0.08	0.05-0.09	0.05-0.09	0.05-0.09	0.05-0.09
0.05-0.08	0.05-0.08	0.05-0.09	0.05-0.09	0.05-0.09	0.05-0.09
0.05-0.08	0.05-0.08	0.05-0.09	0.05-0.09	0.05-0.09	0.05-0.09
0.05-0.10	0.06-0.14	0.08-0.18	0.10-0.22	0.14-0.23	0.15-0.24
0.05-0.10	0.06-0.14	0.08-0.18	0.10-0.22	0.14-0.23	0.15-0.24
0.05-0.09	0.05-0.09	0.05-0.10	0.05-0.10	0.05-0.10	0.05-0.10
0.05-0.09	0.05-0.09	0.05-0.10	0.05-0.10	0.05-0.10	0.05-0.10
0.05-0.09	0.05-0.09	0.05-0.10	0.05-0.10	0.05-0.10	0.05-0.10
0.05-0.09	0.05-0.09	0.05-0.10	0.05-0.10	0.05-0.10	0.05-0.10

Recommended Cutting Conditions



Machining data for T-DRILL 5xD

ISO	Material	Condition	Tensile strength (N/mm ²)	Hardness HB	Material No.	Cutting speed Vc (m/min)		
P	Non-alloy steel, cast steel, free cutting steel	<0.25%C	Annealed	420	125	1	250-350	
		>=0.25%C	Annealed	650	190	2	180-250	
		<0.55%C	Quenched and tempered	850	250	3	160-220	
		>=0.55%C	Annealed	750	220	4	160-220	
			Quenched and tempered	1000	300	5	160-220	
	Low alloy steel and cast steel (Less than 5% of alloying elements)		Annealed		600	200	6	150-220
					930	275	7	120-160
			Quenched and tempered		1000	300	8	120-160
					1200	350	9	120-160
	High alloy steel, cast steel and tool steel		Annealed	680	200	10	140-180	
			Quenched and tempered	1100	325	11	130-180	
M	Stainless steel and cast steel	Ferritic / martensitic	680	200	12	170-240		
		Martensitic	820	240	13	170-240		
		Austenitic	600	180	14	170-240		
K	Gray cast iron (GG)	Ferritic		160	15	180-250		
		Pearlitic		250	16	180-250		
	Cast iron nodular (GGG)	Ferritic		180	17	180-250		
		Pearlitic		260	18	180-250		
	Malleable cast iron	Ferritic		130	19	130-200		
Pearlitic			230	20	130-200			
N	Aluminum - Wrought alloy	Not cureable		60	21	330-380		
		Cured		100	22	330-380		
	Aluminum-cast, alloyed	<=12% Si	Not cureable		75	23	330-380	
			Cured		90	24	330-380	
		>12% Si	High temp.		130	25	330-380	
	Copper alloys		>1% Pb	Free cutting		110	26	150-230
				Brass		90	27	150-230
				Electrolitic copper		100	28	150-230
	Non-metallic		Duroplastics, fiber plastics			29	150-230	
			Hard rubber			30	150-230	
S	High temp. alloys	Fe based	Annealed		200	31	30-60	
			Cured		280	32	30-60	
		Ni or Co based	Annealed		250	33	30-60	
			Cured		350	34	30-60	
			Cast		320	35	30-60	
	Titanium, Ti alloys			Rm 400		36	30-60	
			Alpha+beta alloys cured	Rm 1050		37	30-60	
H	Hardened steel	Hardened		55HRC	38	30-60		
		Hardened		60HRC	39	30-60		
	Chilled cast iron	Cast		400	40	30-60		
	Cast iron nodular	Hardened		55HRC	41	30-60		

• For more information of material groups, see the materials & grades "material conversion table"

■ Steel
 ■ Stainless steel
 ■ Cast iron
 ■ Nonferrous
 ■ High temp. alloys
 ■ Hardened steel

Recommended Cutting Conditions



Machining data for T-DRILL 5xD

Feed (mm/rev) vs. drill diameter Drill length 5xD					
SPMG 05 Ø12.5 - Ø15	SPMG 06 Ø16 - Ø21	SPMG 07 Ø22 - Ø27	SPMG 09 Ø28 - Ø33	SPMG 11 Ø34 - Ø41	SPMG 14 Ø42 - Ø50
0.04-0.05	0.04-0.05	0.04-0.06	0.04-0.07	0.06-0.08	0.06-0.10
0.06-0.08	0.06-0.08	0.06-0.10	0.07-0.12	0.08-0.13	0.08-0.14
0.06-0.10	0.08-0.13	0.10-0.16	0.12-0.20	0.12-0.22	0.13-0.23
0.06-0.10	0.08-0.13	0.10-0.16	0.12-0.20	0.12-0.22	0.13-0.23
0.06-0.10	0.08-0.12	0.10-0.16	0.12-0.18	0.12-0.18	0.13-0.18
0.06-0.12	0.06-0.13	0.08-0.16	0.08-0.16	0.08-0.17	0.08-0.17
0.06-0.12	0.06-0.13	0.08-0.16	0.08-0.16	0.08-0.17	0.08-0.17
0.06-0.12	0.06-0.13	0.08-0.16	0.08-0.16	0.08-0.17	0.08-0.17
0.06-0.08	0.06-0.08	0.08-0.10	0.08-0.12	0.08-0.12	0.08-0.12
0.06-0.09	0.08-0.10	0.10-0.13	0.12-0.13	0.12-0.15	0.12-0.16
0.05-0.09	0.06-0.10	0.08-0.13	0.09-0.15	0.10-0.15	0.10-0.17
0.05-0.09	0.06-0.10	0.08-0.13	0.09-0.15	0.10-0.15	0.10-0.17
0.05-0.09	0.06-0.10	0.08-0.13	0.09-0.15	0.10-0.15	0.10-0.17
0.06-0.10	0.08-0.15	0.12-0.18	0.15-0.22	0.16-0.25	0.18-0.28
0.06-0.10	0.08-0.15	0.12-0.18	0.15-0.22	0.16-0.25	0.18-0.28
0.06-0.10	0.08-0.15	0.12-0.18	0.15-0.22	0.16-0.25	0.18-0.28
0.06-0.10	0.08-0.15	0.12-0.18	0.15-0.22	0.16-0.25	0.18-0.28
0.06-0.08	0.08-0.12	0.10-0.16	0.12-0.18	0.15-0.22	0.16-0.23
0.06-0.08	0.08-0.12	0.10-0.16	0.12-0.18	0.15-0.22	0.16-0.23
0.06-0.12	0.08-0.15	0.10-0.13	0.12-0.18	0.14-0.20	0.14-0.24
0.06-0.12	0.08-0.15	0.10-0.13	0.12-0.18	0.14-0.20	0.14-0.24
0.06-0.12	0.08-0.15	0.10-0.13	0.12-0.18	0.14-0.20	0.14-0.24
0.06-0.12	0.08-0.15	0.10-0.13	0.12-0.18	0.14-0.20	0.14-0.24
0.06-0.12	0.08-0.15	0.10-0.13	0.12-0.18	0.14-0.20	0.14-0.24
0.06-0.12	0.06-0.12	0.08-0.13	0.08-0.13	0.08-0.14	0.08-0.14
0.06-0.12	0.06-0.12	0.08-0.13	0.08-0.13	0.08-0.14	0.08-0.14
0.06-0.12	0.06-0.12	0.08-0.13	0.08-0.13	0.08-0.14	0.08-0.14
0.06-0.12	0.06-0.12	0.08-0.13	0.08-0.13	0.08-0.14	0.08-0.14
0.05-0.07	0.05-0.07	0.05-0.08	0.05-0.08	0.05-0.08	0.05-0.08
0.05-0.07	0.05-0.07	0.05-0.08	0.05-0.08	0.05-0.08	0.05-0.08
0.05-0.07	0.05-0.07	0.05-0.08	0.05-0.08	0.05-0.08	0.05-0.08
0.05-0.07	0.05-0.07	0.05-0.08	0.05-0.08	0.05-0.08	0.05-0.08
0.05-0.07	0.05-0.07	0.05-0.08	0.05-0.08	0.05-0.08	0.05-0.08
0.05-0.09	0.08-0.13	0.08-0.17	0.10-0.20	0.14-0.22	0.14-0.24
0.05-0.09	0.08-0.13	0.08-0.17	0.10-0.20	0.14-0.22	0.14-0.24
0.05-0.08	0.05-0.08	0.05-0.09	0.05-0.09	0.05-0.09	0.05-0.09
0.05-0.08	0.05-0.08	0.05-0.09	0.05-0.09	0.05-0.09	0.05-0.09
0.05-0.08	0.05-0.08	0.05-0.09	0.05-0.09	0.05-0.09	0.05-0.09
0.05-0.08	0.05-0.08	0.05-0.09	0.05-0.09	0.05-0.09	0.05-0.09

Recommended Cutting Conditions

Machining data for DRILL-SPEED

ISO	Material	Condition	Tensile strength (N/mm ²)	Hardness HB	Material No.	
P	Non-alloy steel, cast steel, free cutting steel	<0.25%C	Annealed	420	125	1
		≥0.25%C	Annealed	650	190	2
		<0.55%C	Quenched and tempered	850	250	3
		≥0.55%C	Annealed	750	220	4
			Quenched and tempered	1000	300	5
	Low alloy steel and cast steel (Less than 5% of alloying elements)		Annealed	600	200	6
			Quenched and tempered	930	275	7
				1000	300	8
				1200	350	9
	High alloy steel, cast steel and tool steel		Annealed	680	200	10
			Quenched and tempered	1100	325	11
M	Stainless steel and cast steel	Ferritic / martensitic	680	200	12	
		Martensitic	820	240	13	
		Austenitic	600	180	14	
K	Gray cast iron (GG)	Ferritic		160	15	
		Pearlitic		250	16	
	Cast iron nodular (GGG)	Ferritic		180	17	
		Pearlitic		260	18	
	Malleable cast iron	Ferritic		130	19	
	Pearlitic		230	20		
N	Aluminum - Wrought alloy	Not cureable		60	21	
		Cured		100	22	
	Aluminum-cast, alloyed	≤12% Si	Not cureable		75	23
			Cured		90	24
		>12% Si	High temp.		130	25
	Copper alloys	>1% Pb	Free cutting		110	26
			Brass		90	27
			Electrolitic copper		100	28
	Non-metallic		Duroplastics, fiber plastics			29
			Hard rubber			30
S	High temp. alloys	Fe based	Annealed	200	31	
			Cured	280	32	
		Ni or Co based	Annealed	250	33	
			Cured	350	34	
			Cast	320	35	
	Titanium, Ti alloys			Rm 400		36
			Alpha+beta alloys cured	Rm 1050		37
H	Hardened steel	Hardened		55HRC	38	
		Hardened		60HRC	39	
	Chilled cast iron	Cast		400	40	
	Cast iron nodular	Hardened		55HRC	41	

• For more information of material groups, see the materials & grades "material conversion table"

■ Steel
 ■ Stainless steel
 ■ Cast iron
 ■ Nonferrous
 ■ High temp. alloys
 ■ Hardened steel

Recommended Cutting Conditions

Machining data for DRILL-RUSH

ISO	Material	Condition	Tensile strength (N/mm ²)	Hardness HB	Material No.	Cutting speed Vc (m/min)		
P	Non-alloy steel, cast steel, free cutting steel	<0.25%C	Annealed	420	125	1	80-140	
		>=0.25%C	Annealed	650	190	2	80-130	
		<0.55%C	Quenched and tempered	850	250	3	80-120	
		>=0.55%C	Annealed	750	220	4	70-110	
			Quenched and tempered	1000	300	5	50-90	
	Low alloy steel and cast steel (Less than 5% of alloying elements)		Annealed		600	200	6	70-120
					930	275	7	70-110
			Quenched and tempered		1000	300	8	50-90
					1200	350	9	40-70
	High alloy steel, cast steel and tool steel		Annealed	680	200	10	50-90	
			Quenched and tempered	1100	325	11	40-80	
M	Stainless steel and cast steel	Ferritic / martensitic	680	200	12	40-70		
		Martensitic	820	240	13	40-70		
		Austenitic	600	180	14	30-70		
K	Gray cast iron (GG)	Ferritic		160	15	90-160		
		Pearlitic		250	16	80-140		
	Cast iron nodular (GGG)	Ferritic		180	17	90-180		
		Pearlitic		260	18	80-140		
	Malleable cast iron	Ferritic		130	19	90-160		
Pearlitic			230	20	80-140			
N	Aluminum - Wrought alloy	Not cureable		60	21	90-220		
		Cured		100	22	90-220		
	Aluminum-cast, alloyed	<=12% Si	Not cureable		75	23	90-220	
			Cured		90	24	90-220	
		>12% Si	High temp.		130	25	80-160	
	Copper alloys	>1% Pb	Free cutting		110	26	90-220	
			Brass		90	27	90-220	
			Electrolitic copper		100	28	90-220	
	Non-metallic		Duroplastics, fiber plastics			29		
			Hard rubber				30	
S	High temp. alloys	Fe based	Annealed		200	31	30-60	
			Cured		280	32	20-50	
		Ni or Co based	Annealed		250	33	20-50	
			Cured		350	34	20-50	
			Cast		320	35	20-50	
	Titanium, Ti alloys			Rm 400		36	20-50	
			Alpha+beta alloys cured	Rm 1050		37	20-50	
H	Hardened steel	Hardened		55HRC	38	20-50		
		Hardened		60HRC	39	20-50		
	Chilled cast iron	Cast		400	40			
	Cast iron nodular	Hardened		55HRC	41			

• For more information of material groups, see the materials & grades "material conversion table"

■ Steel
 ■ Stainless steel
 ■ Cast iron
 ■ Nonferrous
 ■ High temp. alloys
 ■ Hardened steel

Recommended Cutting Conditions

Machining data for MODU-R-DRILL

ISO	Material	Condition	Tensile strength (N/mm ²)	Hardness HB	Material No.	Cutting speed Vc (m/min)		
P	Non-alloy steel, cast steel, free cutting steel	<0.25%C	Annealed	420	125	1	120-200	
		>=0.25%C	Annealed	650	190	2	120-200	
		<0.55%C	Quenched and tempered	850	250	3	130-190	
		>=0.55%C	Annealed	750	220	4	130-190	
			Quenched and tempered	1000	300	5	130-190	
	Low alloy steel and cast steel (Less than 5% of alloying elements)		Annealed		600	200	6	100-200
					930	275	7	100-200
			Quenched and tempered		1000	300	8	100-200
					1200	350	9	100-200
	High alloy steel, cast steel and tool steel		Annealed	680	200	10	100-160	
			Quenched and tempered	1100	325	11	100-160	
M	Stainless steel and cast steel	Ferritic / martensitic	680	200	12	80-140		
		Martensitic	820	240	13	80-140		
		Austenitic	600	180	14	80-140		
K	Gray cast iron (GG)	Ferritic		160	15	100-250		
		Pearlitic		250	16	100-250		
	Cast iron nodular (GGG)	Ferritic		180	17	100-250		
		Pearlitic		260	18	100-250		
	Malleable cast iron	Ferritic		130	19	100-250		
Pearlitic			230	20	100-250			
N	Aluminum - Wrought alloy	Not cureable		60	21	160-260		
		Cured		100	22	160-260		
	Aluminum-cast, alloyed	<=12% Si	Not cureable		75	23	160-260	
			Cured		90	24	160-260	
		>12% Si	High temp.		130	25	160-260	
	Copper alloys	>1% Pb	Free cutting		110	26	160-260	
			Brass		90	27	160-260	
			Electrolytic copper		100	28	160-260	
	Non-metallic		Duroplastics, fiber plastics			29		
			Hard rubber			30		
S	High temp. alloys	Fe based	Annealed		200	31	30-60	
			Cured		280	32	30-80	
		Ni or Co based	Annealed		250	33	30-80	
			Cured		350	34	30-80	
			Cast		320	35	30-80	
	Titanium, Ti alloys			Rm 400		36	30-80	
			Alpha+beta alloys cured	Rm 1050		37	30-80	
H	Hardened steel	Hardened		55HRC	38	20-50		
		Hardened		60HRC	39	20-50		
	Chilled cast iron	Cast		400	40			
Cast iron nodular	Hardened		55HRC	41				

• For more information of material groups, see the materials & grades "material conversion table"

■ Steel
 ■ Stainless steel
 ■ Cast iron
 ■ Nonferrous
 ■ High temp. alloys
 ■ Hardened steel

Recommended Cutting Conditions



Machining data for SPADE-RUSH

ISO	Material	Condition	Tensile strength (N/mm ²)	Hardness HB	Material No.	Cutting speed Vc (m/min)		
P	Non-alloy steel, cast steel, free cutting steel	<0.25%C	Annealed	420	125	1	80-140	
		≥0.25%C	Annealed	650	190	2	80-130	
		<0.55%C	Quenched and tempered	850	250	3	80-120	
		≥0.55%C	Annealed	750	220	4	70-110	
			Quenched and tempered	1000	300	5	50-90	
	Low alloy steel and cast steel (Less than 5% of alloying elements)		Annealed		600	200	6	80-120
					930	275	7	70-110
			Quenched and tempered		1000	300	8	50-90
					1200	350	9	40-70
	High alloy steel, cast steel and tool steel		Annealed	680	200	10	50-90	
			Quenched and tempered	1100	325	11	40-80	
M	Stainless steel and cast steel	Ferritic / martensitic	680	200	12	40-70		
		Martensitic	820	240	13	40-70		
		Austenitic	600	180	14	30-70		
K	Gray cast iron (GG)	Ferritic		160	15	90-180		
		Pearlitic		250	16	80-140		
	Cast iron nodular (GGG)	Ferritic		180	17	90-165		
		Pearlitic		260	18	80-140		
	Malleable cast iron	Ferritic		130	19	90-160		
Pearlitic			230	20	80-140			
N	Aluminum - Wrought alloy	Not cureable		60	21	90-220		
		Cured		100	22	90-220		
	Aluminum-cast, alloyed	≤12% Si	Not cureable		75	23	90-220	
			Cured		90	24	90-220	
		>12% Si	High temp.		130	25	80-160	
	Copper alloys	>1% Pb	Free cutting		110	26	90-220	
			Brass		90	27	90-220	
			Electrolitic copper		100	28	90-220	
	Non-metallic		Duroplastics, fiber plastics			29		
			Hard rubber			30		
S	High temp. alloys	Fe based	Annealed		200	31	30-60	
			Cured		280	32	20-50	
		Ni or Co based	Annealed		250	33	20-50	
			Cured		350	34	20-50	
			Cast		320	35	20-50	
	Titanium, Ti alloys		Rm 400		36	20-50		
		Alpha+beta alloys cured	Rm 1050		37	20-50		
H	Hardened steel	Hardened		55HRC	38	20-50		
		Hardened		60HRC	39	20-50		
	Chilled cast iron	Cast		400	40			
	Cast iron nodular	Hardened		55HRC	41			

• For more information of material groups, see the materials & grades "material conversion table"

■ Steel
 ■ Stainless steel
 ■ Cast iron
 ■ Nonferrous
 ■ High temp. alloys
 ■ Hardened steel

Recommended Cutting Conditions

Machining data for SOLID-3-DRILL

ISO	Material	Condition	Tensile strength (N/mm ²)	Hardness HB	Material No.	Cutting speed Vc (m/min)		
P	Non-alloy steel, cast steel, free cutting steel	<0.25%C	Annealed	420	125	1	80-140	
		≥0.25%C	Annealed	650	190	2	80-130	
		<0.55%C	Quenched and tempered	850	250	3	80-120	
		≥0.55%C	Annealed	750	220	4	70-110	
			Quenched and tempered	1000	300	5	50-90	
	Low alloy steel and cast steel (Less than 5% of alloying elements)		Annealed		600	200	6	80-120
					930	275	7	70-110
			Quenched and tempered		1000	300	8	50-90
					1200	350	9	40-70
	High alloy steel, cast steel and tool steel		Annealed	680	200	10	50-90	
			Quenched and tempered	1100	325	11	40-80	
M	Stainless steel and cast steel	Ferritic / martensitic	680	200	12			
		Martensitic	820	240	13			
		Austenitic	600	180	14			
K	Gray cast iron (GG)	Ferritic		160	15	80-140		
		Pearlitic		250	16	70-120		
	Cast iron nodular (GGG)	Ferritic		180	17	80-120		
		Pearlitic		260	18	70-110		
	Malleable cast iron	Ferritic		130	19	80-120		
Pearlitic			230	20	70-110			
N	Aluminum - Wrought alloy	Not cureable		60	21			
		Cured		100	22			
	Aluminum-cast, alloyed	<=12% Si	Not cureable		75	23		
			Cured		90	24		
		>12% Si	High temp.		130	25		
	Copper alloys	>1% Pb	Free cutting		110	26		
			Brass		90	27		
			Electrolitic copper		100	28		
	Non-metallic		Duroplastics, fiber plastics			29		
			Hard rubber				30	
S	High temp. alloys	Fe based	Annealed		200	31		
			Cured		280	32		
		Ni or Co based	Annealed		250	33		
			Cured		350	34		
			Cast		320	35		
	Titanium, Ti alloys			Rm 400		36		
			Alpha+beta alloys cured	Rm 1050		37		
H	Hardened steel	Hardened		55HRC	38			
		Hardened		60HRC	39			
	Chilled cast iron	Cast		400	40			
	Cast iron nodular	Hardened		55HRC	41			

• For more information of material groups, see the materials & grades "material conversion table"

■ Steel
 ■ Stainless steel
 ■ Cast iron
 ■ Nonferrous
 ■ High temp. alloys
 ■ Hardened steel

Recommended Cutting Conditions



Machining data for H-DRILL

ISO	Material	Condition	Tensile strength (N/mm ²)	Hardness HB	Material No.	Cutting speed Vc (m/min)		
P	Non-alloy steel, cast steel, free cutting steel	<0.25%C	Annealed	420	125	1	80-120	
		>=0.25%C	Annealed	650	190	2	80-110	
		<0.55%C	Quenched and tempered	850	250	3	70-100	
		>=0.55%C	Annealed	750	220	4	70-100	
			Quenched and tempered	1000	300	5	70-100	
	Low alloy steel and cast steel (Less than 5% of alloying elements)		Annealed		600	200	6	70-90
					930	275	7	70-90
			Quenched and tempered		1000	300	8	50-80
					1200	350	9	40-70
	High alloy steel, cast steel and tool steel		Annealed	680	200	10	50-80	
			Quenched and tempered	1100	325	11	40-70	
M	Stainless steel and cast steel	Ferritic / martensitic	680	200	12	30-60		
		Martensitic	820	240	13	30-60		
		Austenitic	600	180	14	30-60		
K	Gray cast iron (GG)	Ferritic		160	15	65-80		
		Pearlitic		250	16	65-80		
	Cast iron nodular (GGG)	Ferritic		180	17	85-105		
		Pearlitic		260	18	75-90		
	Malleable cast iron	Ferritic		130	19	65-80		
Pearlitic			230	20	65-80			
N	Aluminum - Wrought alloy	Not cureable		60	21	70-200		
		Cured		100	22	70-200		
	Aluminum-cast, alloyed	<=12% Si	Not cureable		75	23	70-200	
			Cured		90	24	70-200	
		>12% Si	High temp.		130	25	70-150	
	Copper alloys	>1% Pb	Free cutting		110	26	70-200	
			Brass		90	27	70-200	
			Electrolitic copper		100	28	70-200	
	Non-metallic		Duroplastics, fiber plastics			29		
			Hard rubber			30		
S	High temp. alloys	Fe based	Annealed		200	31	15-40	
			Cured		280	32	15-40	
		Ni or Co based	Annealed		250	33	15-40	
			Cured		350	34	15-40	
			Cast		320	35	15-40	
	Titanium, Ti alloys			Rm 400		36		
		Alpha+beta alloys cured		Rm 1050		37		
H	Hardened steel	Hardened		55HRC	38	10-40		
		Hardened		60HRC	39	10-40		
	Chilled cast iron	Cast		400	40			
	Cast iron nodular	Hardened		55HRC	41			

• For more information of material groups, see the materials & grades "material conversion table"

■ Steel
 ■ Stainless steel
 ■ Cast iron
 ■ Nonferrous
 ■ High temp. alloys
 ■ Hardened steel

Recommended Cutting Conditions



Machining data for H-DRILL

Feed (mm/rev) vs. drill diameter		
Ø3 - Ø5	Ø5.1 - Ø8	Ø8.1 - Ø12
0.10-0.20	0.15-0.25	0.20-0.30
0.10-0.20	0.15-0.25	0.20-0.30
0.10-0.20	0.15-0.25	0.20-0.30
0.10-0.20	0.15-0.25	0.20-0.30
0.10-0.20	0.15-0.25	0.20-0.30
0.10-0.20	0.15-0.25	0.20-0.30
0.10-0.20	0.15-0.25	0.20-0.30
0.10-0.20	0.15-0.25	0.20-0.30
0.10-0.20	0.15-0.25	0.20-0.30
0.08-0.18	0.10-0.20	0.15-0.25
0.08-0.18	0.10-0.20	0.15-0.25
0.06-0.12	0.10-0.15	0.12-0.18
0.06-0.12	0.10-0.15	0.12-0.18
0.06-0.12	0.10-0.15	0.12-0.18
0.10-0.20	0.15-0.25	0.20-0.30
0.10-0.20	0.15-0.25	0.20-0.30
0.10-0.20	0.15-0.25	0.20-0.30
0.10-0.20	0.15-0.25	0.20-0.30
0.10-0.20	0.15-0.25	0.20-0.30
0.10-0.25	0.15-0.35	0.25-0.45
0.10-0.25	0.15-0.35	0.25-0.45
0.10-0.25	0.15-0.35	0.25-0.45
0.10-0.25	0.15-0.35	0.25-0.45
0.10-0.25	0.15-0.35	0.25-0.45
0.08-0.18	0.15-0.25	0.20-0.35
0.08-0.18	0.15-0.25	0.20-0.35
0.08-0.18	0.15-0.25	0.20-0.35
0.02-0.08	0.04-0.10	0.06-0.12
0.02-0.08	0.04-0.10	0.06-0.12
0.02-0.08	0.04-0.10	0.06-0.12
0.02-0.08	0.04-0.10	0.06-0.12
0.02-0.08	0.04-0.10	0.06-0.12
0.02-0.08	0.04-0.10	0.06-0.12
0.02-0.08	0.04-0.10	0.06-0.12

Recommended Cutting Conditions



Machining data for TOP-CAP

ISO	Material	Condition	Tensile strength (N/mm ²)	Hardness HB	Material No.	
P	Non-alloy steel, cast steel, free cutting steel	<0.25%C	Annealed	420	125	1
		>=0.25%C	Annealed	650	190	2
		<0.55%C	Quenched and tempered	850	250	3
		>=0.55%C	Annealed	750	220	4
			Quenched and tempered	1000	300	5
	Low alloy steel and cast steel (Less than 5% of alloying elements)	Annealed		600	200	6
				930	275	7
		Quenched and tempered		1000	300	8
				1200	350	9
	High alloy steel, cast steel and tool steel	Annealed	680	200	10	
		Quenched and tempered	1100	325	11	
M	Stainless steel and cast steel	Ferritic / martensitic	680	200	12	
		Martensitic	820	240	13	
		Austenitic	600	180	14	
K	Gray cast iron (GG)	Ferritic		160	15	
		Pearlitic		250	16	
	Cast iron nodular (GGG)	Ferritic		180	17	
		Pearlitic		260	18	
	Malleable cast iron	Ferritic		130	19	
Pearlitic			230	20		
N	Aluminum - Wrought alloy	Not cureable		60	21	
		Cured		100	22	
	Aluminum-cast, alloyed	<=12% Si	Not cureable		75	23
			Cured		90	24
		>12% Si	High temp.		130	25
	Copper alloys	>1% Pb	Free cutting		110	26
			Brass		90	27
			Electrolitic copper		100	28
	Non-metallic		Duroplastics, fiber plastics			29
			Hard rubber			30
S	High temp. alloys	Fe based	Annealed		200	31
			Cured		280	32
		Ni or Co based	Annealed		250	33
			Cured		350	34
			Cast		320	35
	Titanium, Ti alloys		Rm 400			36
			Alpha+beta alloys cured	Rm 1050		
H	Hardened steel	Hardened		55HRC	38	
		Hardened		60HRC	39	
	Chilled cast iron	Cast		400	40	
	Cast iron nodular	Hardened		55HRC	41	

• For more information of material groups, see the materials & grades "material conversion table"

■ Steel
 ■ Stainless steel
 ■ Cast iron
 ■ Nonferrous
 ■ High temp. alloys
 ■ Hardened steel

Recommended Cutting Conditions



Machining data for TOP-CAP

Drilling		Turning & boring		Grooving	
Vc (m/min)	Feed (mm/rev)	Vc (m/min)	Feed (mm/rev)	Vc (m/min)	Feed (mm/rev)
120-260	0.05-0.06	140-280	0.04-0.14	120-250	0.04-0.25
80-190	0.05-0.15	90-200	0.04-0.12	80-180	0.04-0.25
100-280	0.06-0.18	100-200	0.04-0.15	80-180	0.04-0.25
100-280	0.06-0.18	100-200	0.04-0.15	80-180	0.04-0.25
100-280	0.06-0.18	100-200	0.04-0.15	80-180	0.04-0.25
100-280	0.06-0.18	100-200	0.04-0.15	80-180	0.04-0.25
60-180	0.04-0.15	80-180	0.07-0.12	60-160	0.04-0.25
60-180	0.04-0.15	80-180	0.07-0.12	60-160	0.04-0.25
60-180	0.04-0.15	80-180	0.07-0.12	60-160	0.04-0.25
80-190	0.05-0.15	80-200	0.04-0.12	80-160	0.04-0.25
50-150	0.04-0.14	60-150	0.04-0.12	50-120	0.04-0.25
50-210	0.04-0.15	60-230	0.07-0.12	50-200	0.04-0.25
50-210	0.04-0.15	60-230	0.07-0.12	50-200	0.04-0.25
50-210	0.04-0.15	60-230	0.07-0.12	50-200	0.04-0.25
100-300	0.06-0.23	120-230	0.07-0.2	100-200	0.04-0.25
100-300	0.06-0.23	120-230	0.07-0.2	100-200	0.04-0.25
100-300	0.06-0.23	120-230	0.07-0.2	100-200	0.04-0.25
100-300	0.06-0.23	120-230	0.07-0.2	100-200	0.04-0.25
100-200	0.06-0.15	120-230	0.04-0.13	100-200	0.04-0.25
100-200	0.06-0.15	120-230	0.04-0.13	100-200	0.04-0.25
120-500	0.05-0.3	120-700	0.04-0.25	100-700	0.04-0.25
120-500	0.05-0.3	120-700	0.04-0.25	100-700	0.04-0.25
120-500	0.05-0.3	120-700	0.04-0.25	100-700	0.04-0.25
120-500	0.05-0.3	120-700	0.04-0.25	100-700	0.04-0.25
80-380	0.05-0.23	80-500	0.04-0.2	80-350	0.04-0.25
80-380	0.05-0.23	80-500	0.04-0.2	80-350	0.04-0.25
80-380	0.05-0.23	80-500	0.04-0.2	80-350	0.04-0.25
50-140	0.04-0.14	50-160	0.04-0.12	50-140	0.04-0.25
50-140	0.04-0.14	50-160	0.04-0.12	50-140	0.04-0.25
20-50	0.04-0.05	20-80	0.04-0.05	20-50	0.04-0.05
20-50	0.04-0.05	20-80	0.04-0.05	20-50	0.04-0.05
20-50	0.04-0.05	20-80	0.04-0.05	20-50	0.04-0.05
20-50	0.04-0.05	20-80	0.04-0.05	20-50	0.04-0.05
20-50	0.04-0.05	20-80	0.04-0.05	20-50	0.04-0.05
30-60	0.04-0.05	30-100	0.04-0.05	30-80	0.04-0.05
30-60	0.04-0.05	30-100	0.04-0.05	30-80	0.04-0.05
20-40	0.04-0.05	20-70	0.04-0.05	20-50	0.04-0.05
20-40	0.04-0.05	20-70	0.04-0.05	20-50	0.04-0.05
20-40	0.04-0.05	20-70	0.04-0.05	20-50	0.04-0.05
20-40	0.04-0.05	20-70	0.04-0.05	20-50	0.04-0.05

Recommended Cutting Conditions



Machining data for TBTA 3/5/7/9 & TBTA-R

ISO	Material	Condition	Tensile strength (N/mm ²)	Hardness HB	Material No.	Cutting speed Vc (m/min)		
P	Non-alloy steel, cast steel, free cutting steel	<0.25%C	Annealed	420	125	1	60-120	
		≥0.25%C	Annealed	650	190	2	60-120	
		<0.55%C	Quenched and tempered	850	250	3	60-120	
		≥0.55%C	Annealed	750	220	4	60-120	
			Quenched and tempered	1000	300	5	50-100	
	Low alloy steel and cast steel (Less than 5% of alloying elements)		Annealed		600	200	6	50-100
					930	275	7	50-100
			Quenched and tempered		1000	300	8	50-100
					1200	350	9	50-100
	High alloy steel, cast steel and tool steel		Annealed	680	200	10	60-120	
			Quenched and tempered	1100	325	11	60-120	
M	Stainless steel and cast steel	Ferritic / martensitic	680	200	12	60-110		
		Martensitic	820	240	13	60-110		
		Austenitic	600	180	14	60-110		
K	Gray cast iron (GG)	Ferritic		160	15	60-100		
		Pearlitic		250	16	60-100		
	Cast iron nodular (GGG)	Ferritic		180	17	60-100		
		Pearlitic		260	18	60-100		
	Malleable cast iron	Ferritic		130	19	60-100		
Pearlitic			230	20	60-100			
N	Aluminum - Wrought alloy	Not cureable		60	21	60-130		
		Cured		100	22	60-130		
	Aluminum-cast, alloyed	<=12% Si	Not cureable		75	23	60-130	
			Cured		90	24	60-130	
		>12% Si	High temp.		130	25	60-130	
	Copper alloys	>1% Pb	Free cutting		110	26	60-130	
			Brass		90	27	60-130	
			Electrolitic copper		100	28	60-130	
	Non-metallic		Duroplastics, fiber plastics			29		
			Hard rubber				30	
S	High temp. alloys	Fe based	Annealed		200	31	20-65	
			Cured		280	32	20-65	
		Ni or Co based	Annealed		250	33	20-65	
			Cured		350	34	20-65	
			Cast		320	35	20-65	
	Titanium, Ti alloys			Rm 400		36	30-100	
			Alpha+beta alloys cured	Rm 1050		37	30-100	
H	Hardened steel	Hardened		55HRC	38			
		Hardened		60HRC	39			
	Chilled cast iron	Cast		400	40			
	Cast iron nodular	Hardened		55HRC	41			

• For more information of material groups, see the materials & grades "material conversion table"

■ Steel
 ■ Stainless steel
 ■ Cast iron
 ■ Nonferrous
 ■ High temp. alloys
 ■ Hardened steel

Recommended Cutting Conditions



Machining data for TBTA-FB

ISO	Material	Condition	Tensile strength (N/mm ²)	Hardness HB	Material No.	Cutting speed Vc (m/min)		
P	Non-alloy steel, cast steel, free cutting steel	<0.25%C	Annealed	420	125	1	70-130	
		≥0.25%C	Annealed	650	190	2	70-130	
		<0.55%C	Quenched and tempered	850	250	3	70-130	
		≥0.55%C	Annealed	750	220	4	70-130	
			Quenched and tempered	1000	300	5	70-130	
	Low alloy steel and cast steel (Less than 5% of alloying elements)		Annealed		600	200	6	70-120
					930	275	7	60-120
			Quenched and tempered		1000	300	8	60-120
					1200	350	9	60-120
	High alloy steel, cast steel and tool steel		Annealed	680	200	10	70-130	
			Quenched and tempered	1100	325	11	70-130	
M	Stainless steel and cast steel	Ferritic / martensitic	680	200	12	70-130		
		Martensitic	820	240	13	70-130		
		Austenitic	600	180	14	70-130		
K	Gray cast iron (GG)	Ferritic		160	15	60-110		
		Pearlitic		250	16	60-110		
	Cast iron nodular (GGG)	Ferritic		180	17	50-110		
		Pearlitic		260	18	50-110		
	Malleable cast iron	Ferritic		130	19	70-110		
Pearlitic			230	20	70-110			
N	Aluminum - Wrought alloy	Not cureable		60	21	65-130		
		Cured		100	22	65-130		
	Aluminum-cast, alloyed	<=12% Si	Not cureable		75	23	65-130	
			Cured		90	24	65-130	
		>12% Si	High temp.		130	25	65-130	
	Copper alloys	>1% Pb	Free cutting		110	26	65-130	
			Brass		90	27	65-130	
			Electrolitic copper		100	28	65-130	
	Non-metallic		Duroplastics, fiber plastics			29		
			Hard rubber				30	
S	High temp. alloys	Fe based	Annealed		200	31	20-50	
			Cured		280	32	20-50	
		Ni or Co based	Annealed		250	33	20-50	
			Cured		350	34	20-50	
			Cast		320	35	20-50	
	Titanium, Ti alloys			Rm 400		36	30-60	
			Alpha+beta alloys cured	Rm 1050		37	30-60	
H	Hardened steel	Hardened		55HRC	38			
		Hardened		60HRC	39			
	Chilled cast iron	Cast		400	40			
	Cast iron nodular	Hardened		55HRC	41			

• For more information of material groups, see the materials & grades "material conversion table"

■ Steel
 ■ Stainless steel
 ■ Cast iron
 ■ Nonferrous
 ■ High temp. alloys
 ■ Hardened steel

Recommended Cutting Conditions



Machining data for BTA & BTS

ISO	Material	Condition	Tensile strength (N/mm ²)	Hardness HB	Material No.	Cutting speed Vc (m/min)	
P	Non-alloy steel, cast steel, free cutting steel	<0.25%C	Annealed	420	125	1	70-120
		≥0.25%C	Annealed	650	190	2	70-120
		<0.55%C	Quenched and tempered	850	250	3	40-70
		≥0.55%C	Annealed	750	220	4	70-120
		Quenched and tempered	1000	300	5	55-100	
	Low alloy steel and cast steel (Less than 5% of alloying elements)	Quenched and tempered	Annealed	600	200	6	70-100
			930	275	7	55-100	
			1000	300	8	55-100	
			1200	350	9	55-100	
	High alloy steel, cast steel and tool steel	Annealed	680	200	10	50-85	
		Quenched and tempered	1100	325	11	55-100	
M	Stainless steel and cast steel	Ferritic / martensitic	680	200	12	60-100	
		Martensitic	820	240	13	60-100	
		Austenitic	600	180	14	60-100	
K	Gray cast iron (GG)	Ferritic		160	15	60-100	
		Pearlitic		250	16	60-100	
	Cast iron nodular (GGG)	Ferritic		180	17	80-100	
		Pearlitic		260	18	80-100	
	Malleable cast iron	Ferritic		130	19	50-100	
Pearlitic			230	20	50-100		
N	Aluminum - Wrought alloy	Not cureable		60	21	65-130	
		Cured		100	22	65-100	
	Aluminum-cast, alloyed	<=12% Si	Not cureable		75	23	65-130
			Cured		90	24	65-130
		>12% Si	High temp.		130	25	65-130
	Copper alloys	>1% Pb	Free cutting		110	26	65-130
		Brass			90	27	65-130
			Electrolytic copper		100	28	65-130
	Non-metallic		Duroplastics, fiber plastics			29	
			Hard rubber			30	
S	High temp. alloys	Fe based	Annealed		200	31	10-50
			Cured		280	32	10-50
		Ni or Co based	Annealed		250	33	10-50
			Cured		350	34	10-50
			Cast		320	35	10-50
	Titanium, Ti alloys		Rm 400		36	30-50	
		Alpha+beta alloys cured	Rm 1050		37	30-50	
H	Hardened steel	Hardened		55HRC	38		
		Hardened		60HRC	39		
	Cast iron nodular	Cast		400	40		
	Cast iron nodular	Hardened		55HRC	41		

• For more information of material groups, see the materials & grades "material conversion table"

■ Steel
 ■ Stainless steel
 ■ Cast iron
 ■ Nonferrous
 ■ High temp. alloys
 ■ Hardened steel

Recommended Cutting Conditions



Machining data for TRGD / TRGDL / TBTA-TR

ISO	Material	Condition	Tensile strength (N/mm ²)	Hardness HB	Material No.		
P	Non-alloy steel, cast steel, free cutting steel	<0.25%C	Annealed	420	125	1	
		≥0.25%C	Annealed	650	190	2	
		<0.55%C	Quenched and tempered	850	250	3	
		≥0.55%C	Annealed	750	220	4	
			Quenched and tempered	1000	300	5	
	Low alloy steel and cast steel (Less than 5% of alloying elements)	Annealed		600	200	6	
				930	275	7	
		Quenched and tempered		1000	300	8	
				1200	350	9	
	High alloy steel, cast steel and tool steel	Annealed		680	200	10	
		Quenched and tempered		1100	325	11	
M	Stainless steel and cast steel	Ferritic / martensitic		680	200	12	
		Martensitic		820	240	13	
		Austenitic		600	180	14	
K	Gray cast iron (GG)	Ferritic			160	15	
		Pearlitic			250	16	
	Cast iron nodular (GGG)	Ferritic			180	17	
		Pearlitic			260	18	
	Malleable cast iron	Ferritic			130	19	
Pearlitic				230	20		
N	Aluminum - Wrought alloy	Not cureable			60	21	
		Cured			100	22	
	Aluminum-cast, alloyed	≤12% Si	Not cureable			75	23
			Cured			90	24
		>12% Si	High temp.			130	25
	Copper alloys	>1% Pb	Free cutting			110	26
			Brass			90	27
			Electrolitic copper			100	28
	Non-metallic		Duroplastics, fiber plastics				29
			Hard rubber				
S	High temp. alloys	Fe based	Annealed			200	31
			Cured			280	32
		Ni or Co based	Annealed			250	33
			Cured			350	34
			Cast			320	35
	Titanium, Ti alloys			Rm 400			36
		Alpha+beta alloys cured		Rm 1050			37
H	Hardened steel	Hardened			55 HRC	38	
		Hardened			60 HRC	39	
	Chilled cast iron	Cast			400	40	
	Cast iron nodular	Hardened			55 HRC	41	

• For more information of material groups, see the materials & grades "material conversion table"

■ Steel
 ■ Stainless steel
 ■ Cast iron
 ■ Nonferrous
 ■ High temp. alloys
 ■ Hardened steel

Recommended Cutting Conditions



Machining data for TRGD / TRGDL / TBTA-TR

Feed (mm/rev) vs. drill diameter					
TRGD / TRGDL			TBTA-TR		
Cutting speed Vc (m/min)	Ø14.00-Ø15.99	Ø16.00-Ø28.00	Ø28.01-Ø40.00	Cutting speed Vc (m/min)	Ø16.00-Ø28.00
80-140	0.05-0.10	0.05-0.10	0.05-0.15	90-130	0.15-0.20
80-140	0.05-0.10	0.05-0.10	0.05-0.15	90-130	0.15-0.20
80-140	0.05-0.16	0.05-0.20	0.05-0.20	90-130	0.15-0.20
80-140	0.05-0.16	0.05-0.20	0.05-0.20	70-130	0.10-0.25
80-140	0.05-0.16	0.05-0.20	0.05-0.20	70-130	0.10-0.25
80-140	0.05-0.10	0.05-0.10	0.05-0.15	70-120	0.10-0.25
80-120	0.05-0.16	0.05-0.20	0.05-0.20	60-120	0.10-0.25
80-120	0.05-0.16	0.05-0.20	0.05-0.20	60-120	0.10-0.25
80-120	0.05-0.16	0.05-0.20	0.05-0.20	60-120	0.10-0.25
80-140	0.05-0.10	0.05-0.10	0.05-0.15	70-130	0.10-0.25
80-120	0.05-0.16	0.05-0.20	0.05-0.20	70-130	0.10-0.25
60-100	0.05-0.10	0.05-0.10	0.05-0.15	80-130	0.06-0.10
60-100	0.05-0.10	0.05-0.10	0.05-0.15	80-130	0.06-0.10
60-100	0.05-0.10	0.05-0.10	0.05-0.15	80-130	0.06-0.10
80-140	0.05-0.25	0.05-0.30	0.05-0.30	50-110	0.10-0.20
80-140	0.05-0.25	0.05-0.30	0.05-0.30	50-110	0.10-0.20
80-140	0.05-0.25	0.05-0.30	0.05-0.30	60-110	0.10-0.20
80-140	0.05-0.25	0.05-0.30	0.05-0.30	60-110	0.10-0.20
80-140	0.05-0.25	0.05-0.30	0.05-0.30	70-110	0.10-0.20
80-140	0.05-0.25	0.05-0.30	0.05-0.30	70-110	0.10-0.20
100-200	0.05-0.20	0.05-0.20	0.05-0.25	65-130	0.08-0.18
100-200	0.05-0.20	0.05-0.20	0.05-0.25	65-130	0.08-0.18
100-200	0.05-0.20	0.05-0.20	0.05-0.25	65-130	0.08-0.18
				65-130	0.08-0.18
				65-130	0.08-0.18
				65-130	0.08-0.18
				65-130	0.08-0.18
				65-130	0.08-0.18
				65-130	0.08-0.18
20-50	0.04-0.08	0.04-0.10	0.04-0.13	20-50	0.08-0.18
20-50	0.04-0.08	0.04-0.10	0.04-0.13	20-50	0.08-0.18
20-50	0.04-0.08	0.04-0.10	0.04-0.13	20-50	0.08-0.18
20-50	0.04-0.08	0.04-0.10	0.04-0.13	20-50	0.08-0.18
20-50	0.04-0.08	0.04-0.10	0.04-0.13	20-50	0.08-0.18
30-60	0.05-0.13	0.05-0.15	0.05-0.18	30-60	0.08-0.18
30-60	0.05-0.13	0.05-0.15	0.05-0.18	30-60	0.08-0.18
50-100	0.04-0.08	0.04-0.10	0.04-0.13		
50-100	0.04-0.08	0.04-0.10	0.04-0.13		
50-100	0.04-0.08	0.04-0.10	0.04-0.13		
50-100	0.04-0.08	0.04-0.10	0.04-0.13		

Reaming Tools



TM...KEY

Clamping keys



Designation	Clamping key	
	Head diameter range (mm)	SSC
TM - B5-KEY	11.501-13.500	B5
B6-KEY	13.501-16.000	B6
B7-KEY	16.001-20.000	B7
B8-KEY	20.001-25.400	B8
B9-KEY	25.401-32.000	B9

• SSC: Seat size code

TM...SCR

Clamping screws

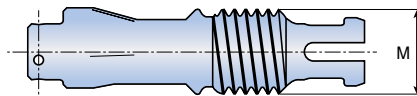

Designation	Clamping screw	
	Head diameter range (mm)	M
TM - B5-SCR	11.501-13.500	M5
B6-SCR	13.501-16.000	M6
B7-SCR	16.001-20.000	M7
B8-SCR	20.001-25.400	M8
B9-SCR	25.401-32.000	M9

Head changeable reamer heads

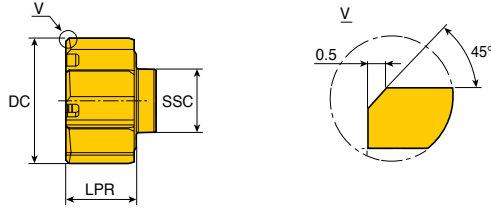

- Straight flute for blind hole
- For H7 hole tolerance

Head	Designation	Dimension (mm)		NOF	SSC	Flute type	Edge type	Grade TT9030	
		DC	LPR						
	TM- 11.501-AS-B5	11.501	9.5	6	B5	S	A	●	
	12.000-AS-B5	12.000	9.5	6	B5	S	A	●	
	13.000-AS-B5	13.000	9.5	6	B5	S	A	●	
	13.500-AS-B5	13.500	9.5	6	B5	S	A	●	
	13.501-AS-B6	13.501	9.5	6	B6	S	A	●	
	14.000-AS-B6	14.000	9.5	6	B6	S	A	●	
	15.000-AS-B6	15.000	9.5	6	B6	S	A	●	
	16.000-AS-B6	16.000	9.5	6	B6	S	A	●	
	16.001-AS-B7	16.001	10.7	6	B7	S	A	●	
	17.000-AS-B7	17.000	10.7	6	B7	S	A	●	
	18.000-AS-B7	18.000	10.7	6	B7	S	A	●	
	19.000-AS-B7	19.000	10.7	6	B7	S	A	●	
	20.000-AS-B7	20.000	10.7	6	B7	S	A	●	
	20.001-AS-B8	20.001	12.9	8	B8	S	A	●	
	21.000-AS-B8	21.000	12.9	8	B8	S	A	●	
	22.000-AS-B8	22.000	12.9	8	B8	S	A	●	
	23.000-AS-B8	23.000	12.9	8	B8	S	A	●	
	24.000-AS-B8	24.000	12.9	8	B8	S	A	●	
	25.000-AS-B8	25.000	12.9	8	B8	S	A	●	
	26.000-AS-B9	26.000	12.9	8	B9	S	A	●	
	27.000-AS-B9	27.000	12.9	8	B9	S	A	●	
	28.000-AS-B9	28.000	12.9	8	B9	S	A	●	
	29.000-AS-B9	29.000	12.9	8	B9	S	A	●	
	30.000-AS-B9	30.000	12.9	8	B9	S	A	●	
	31.000-AS-B9	31.000	12.9	8	B9	S	A	●	
	32.000-AS-B9	32.000	12.9	8	B9	S	A	●	



- NOF: Number of flutes
- SSC: Seat size code

●: Standard items

Recommended Cutting Conditions

Machining data for TS-REAM

ISO	Material	Condition	Tensile strength (N/mm ²)	Hardness HB	Material No.	Cutting speed Vc (m/min)	
P	Non-alloy steel, cast steel, free cutting steel	<0.25%C	Annealed	420	125	1	120-250
		≥0.25%C	Annealed	650	190	2	120-250
		<0.55%C	Quenched and tempered	850	250	3	120-250
		≥0.55%C	Annealed	750	220	4	
	Low alloy steel and cast steel (Less than 5% of alloying elements)	Quenched and tempered	1000	300	5		
			600	200	6	120-250	
		Quenched and tempered	930	275	7	120-250	
			1000	300	8	120-250	
			1200	350	9	120-250	
	High alloy steel, cast steel and tool steel	Annealed	680	200	10	120-250	
		Quenched and tempered	1100	325	11	120-250	
M	Stainless steel and cast steel	Ferritic / martensitic	680	200	12	60-120	
		Martensitic	820	240	13	60-120	
		Austenitic	600	180	14	60-120	
K	Gray cast iron (GG)	Ferritic		160	15	60-120	
		Pearlitic		250	16	60-120	
	Cast iron nodular (GGG)	Ferritic		180	17	60-120	
		Pearlitic		260	18	60-120	
	Malleable cast iron	Ferritic		130	19	60-120	
Pearlitic			230	20	60-120		
N	Aluminum - Wrought alloy	Not cureable		60	21	250-500	
		Cured		100	22	250-500	
	Aluminum-cast, alloyed	<=12% Si	Not cureable		75	23	250-500
			Cured		90	24	250-500
		>12% Si	High temp.		130	25	
	Copper alloys	>1% Pb	Free cutting		110	26	
			Brass		90	27	
		Electrolitic copper		100	28		
Non-metallic	Duroplastics, fiber plastics				29		
	Hard rubber				30		
S	High temp. alloys	Fe based	Annealed		200	31	
			Cured		280	32	
		Ni or Co based	Annealed		250	33	25-50
			Cured		350	34	25-50
	Titanium, Ti alloys	Cast		320	35		
			Rm 400		36	30-80	
H	Hardened steel	Hardened		55HRC	38	25-60	
		Hardened		60HRC	39		
	Chilled cast iron	Cast		400	40		
	Cast iron nodular	Hardened		55HRC	41		

• For more information of material groups, see the materials & grades "material conversion table"

■ Steel
 ■ Stainless steel
 ■ Cast iron
 ■ Nonferrous
 ■ High temp. alloys
 ■ Hardened steel

Recommended Cutting Conditions



Machining data for TM-REAM - Through hole

ISO	Material	Condition	Material No.	Through hole		Interrupted through Hole		
P	Non-alloy steel, cast steel, free cutting steel	<0.25%C	Annealed	1	TT9030	BL	TT9030	BL
		>=0.25%C	Annealed	2	Vc = 80 - 200		Vc = 60 - 120	
		<0.55%C	Quenched and tempered	3	B4 - B6	fz = 0.08 - 0.21	B4 - B6	fz = 0.08 - 0.21
		>=0.55%C	Annealed	4				
	Low alloy steel and cast steel (Less than 5% of alloying elements)	Quenched and tempered		5	B7 - B9	fz = 0.12 - 0.27	B7 - B9	fz = 0.09 - 0.21
		Annealed		6	TT9030	BL	TT9030	BL
		Quenched and tempered		7	Vc = 80 - 200		Vc = 60 - 120	
	High alloy steel, cast steel and tool steel	Quenched and tempered		8	B4 - B6	fz = 0.08 - 0.21	B4 - B6	fz = 0.08 - 0.21
		Quenched and tempered		9	B7 - B9	fz = 0.12 - 0.27	B7 - B9	fz = 0.09 - 0.21
		Annealed		10	TT9030	BL	TT9030	BL
		Quenched and tempered		11	Vc = 20 - 60		Vc = 20 - 60	
M	Stainless steel and cast steel	Ferritic / martensitic		12	TT9030	BL	TT9030	BL
		Martensitic		13	Vc = 20 - 40		Vc = 20 - 40	
		Austenitic		14	B4 - B6	fz = 0.05 - 0.13	B4 - B6	fz = 0.04 - 0.11
K	Gray cast iron (GG)	Ferritic		15	B7 - B9	fz = 0.07 - 0.17	B7 - B9	fz = 0.05 - 0.14
		Pearlitic		16	Vc = 120 - 220		Vc = 80 - 200	
	Cast iron nodular (GGG)	Ferritic		17	B4 - B6	fz = 0.08 - 0.18	B4 - B6	fz = 0.05 - 0.13
		Pearlitic		18	B7 - B9	fz = 0.10 - 0.24	B7 - B9	fz = 0.07 - 0.17
	Malleable cast iron	Ferritic		19	TT9030	AS or BL	TT9030	BL
		Pearlitic		20	Vc = 160 - 280		Vc = 150 - 250	
		Ferritic		19	B4 - B6	fz = 0.11 - 0.20	B4 - B6	fz = 0.06 - 0.15
		Pearlitic		20	B7 - B9	fz = 0.11 - 0.24	B7 - B9	fz = 0.08 - 0.19

• For more information of material groups, see the materials & grades "material conversion table"

■ Steel
 ■ Stainless steel
 ■ Cast iron
 ■ Nonferrous
 ■ High temp. alloys
 ■ Hardened steel

Recommended Cutting Conditions



Machining data for TM-REAM - Through hole

ISO	Material	Condition	Material No.	Through hole		Interrupted through Hole		
N	Aluminum - Wrought alloy	Not cureable	21	B7 - B9	BL or GS	TTAL10	BL	
		Cured	22	Vc = 150 - 400		Vc = 150 - 400		
	Aluminum-cast, alloyed	<=12% Si	Not cureable	23	B4 - B6	fz = 0.08 - 0.16	B4 - B6	fz = 0.08 - 0.16
		Cured	24					
	>12% Si	High temp.	25	B7 - B9	fz = 0.10 - 0.20	B7 - B9	fz = 0.10 - 0.20	
		Copper alloys	>1% Pb	Free cutting	26	TT9030	BL	TT9030
	Vc = 50 - 200					Vc = 50 - 200		
	Brass		27	B4 - B6	fz = 0.08 - 0.18	B4 - B6	fz = 0.05 - 0.13	
	Non-metallic		Electrolitic copper	28	B7 - B9	fz = 0.10 - 0.23	B7 - B9	fz = 0.07 - 0.16
			Duroplastics, fiber plastics	29	TT9030	AS	TT9030	AS
Vc = 25 - 80					Vc = 25 - 80			
Hard rubber			30	B4 - B6	fz = 0.05 - 0.10	B4 - B6	fz = 0.05 - 0.10	
	B7 - B9	fz = 0.10 - 0.20		B7 - B9	fz = 0.10 - 0.20			
S	High temp. alloys	Fe based	Annealed	31	TT9030	L *	TT9030	L *
			Cured	32	Vc = 15 - 50		Vc = 15 - 50	
		Ni or Co based	Annealed	33	B4 - B6	fz = 0.04 - 0.10	B4 - B6	fz = 0.03 - 0.08
			Cured	34				
			Cast	35				
	Titanium, Ti alloys	Alpha+beta alloys cured	36	B7 - B9	fz = 0.05 - 0.13	B4 - B6	fz = 0.04 - 0.11	
37								
H	Hardened steel	Hardened	38	TT9030	BL	TT9030	BL	
		Hardened	39	Vc = 25 - 50		Vc = 25 - 50		
	Chilled cast iron	Cast	40	B4 - B6	fz = 0.06 - 0.15	B4 - B6	fz = 0.06 - 0.15	
	Cast iron nodular	Hardened	41	B7 - B9	fz = 0.10 - 0.20	B7 - B9	fz = 0.10 - 0.20	

* Standard edge geometries are not suitable for reaming titanium and high temperature alloys. In order to choose a proper geometry, please ask for our recommendations.

- The given cutting data recommendations refer to the short holders (3xD effective reaming overhang). For longer holders, the cutting speed to be reduced proportionally.
- For relatively large leading angles (spot-facing geometries), the feed to be reduced up to 30%.
- All the given cutting data recommendations refer to the machines with spindle through coolant supply.

Legend:

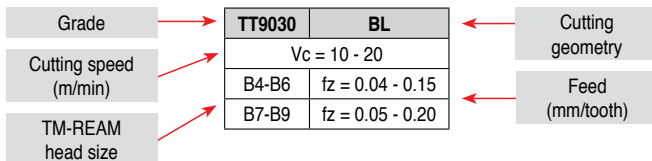

Recommended Cutting Conditions



Machining data for TM-REAM - Blind hole

ISO	Material	Condition	Material No.	Blind hole		Interrupted blind hole			
P	Non-alloy steel, cast steel, free cutting steel	<0.25%C	Annealed	1	TT9030	AS	TT9030	AS	
		>=0.25%C	Annealed	2	Vc = 60-160		Vc = 60 - 120		
		<0.55%C	Quenched and tempered	3	B4 - B6	fz = 0.06 - 0.18	B4 - B6	fz = 0.05 - 0.15	
		>=0.55%C	Annealed	4					
	Low alloy steel and cast steel (Less than 5% of alloying elements)	Quenched and tempered		5	B7 - B9	fz = 0.08 - 0.20	B7 - B9	fz = 0.07 - 0.16	
		Annealed		6	TT9030	AS	TT9030	AS	
		Quenched and tempered		7	Vc = 60-160		Vc = 60 - 120		
	8			B4 - B6	fz = 0.06 - 0.18	B4 - B6	fz = 0.05 - 0.15		
	9	B7 - B9	fz = 0.08 - 0.20	B7 - B9	fz = 0.07 - 0.16				
	High alloy steel, cast steel and tool steel	Annealed		10	TT9030	AS	TT9030	AS	
		Quenched and tempered		Vc = 20 - 60		Vc = 20 - 60			
11				B4 - B6	fz = 0.04 - 0.10	B4 - B6	fz = 0.03 - 0.08		
				B7 - B9	fz = 0.05 - 0.13	B7 - B9	fz = 0.04 - 0.10		
M	Stainless steel and cast steel	Ferritic / martensitic		12	TT9030	AS	TT9030	AS	
		Martensitic		Vc = 20 - 40		Vc = 20 - 40			
		Austenitic		13	B4 - B6	fz = 0.04 - 0.10	B4 - B6	fz = 0.03 - 0.08	
				14	B7 - B9	fz = 0.05 - 0.13	B7 - B9	fz = 0.05 - 0.10	
K	Gray cast iron (GG)	Ferritic		15	TT9030	AS	TT9030	AS	
		Pearlitic		Vc = 80 - 200		Vc = 60 - 120			
	Cast iron nodular (GGG)	Ferritic		16	B4 - B6	fz = 0.06 - 0.18	B4 - B6	fz = 0.05 - 0.13	
		Pearlitic		17	B7 - B9	fz = 0.08 - 0.23	B7 - B9	fz = 0.08 - 0.18	
	Malleable cast iron	Ferritic		17	TT9030	AS	TT9030	AS	
		Pearlitic		Vc = 160 - 280		Vc = 160 - 240			
					18	B4 - B6	fz = 0.06 - 0.18	B4 - B6	fz = 0.06 - 0.16
						B7 - B9	fz = 0.08 - 0.23	B7 - B9	fz = 0.08 - 0.18
				19	TT9030	AS	TT9030	AS	
				Vc = 100 - 220		Vc = 100 - 220			
				20	B4 - B6	fz = 0.06 - 0.18	B4 - B6	fz = 0.05 - 0.15	
					B7 - B9	fz = 0.08 - 0.23	B7 - B9	fz = 0.08 - 0.20	

• For more information of material groups, see the materials & grades "material conversion table"

■ Steel
 ■ Stainless steel
 ■ Cast iron
 ■ Nonferrous
 ■ High temp. alloys
 ■ Hardened steel

Recommended Cutting Conditions



Machining data for TM-REAM - Blind hole

ISO	Material	Condition	Material No.	Blind hole		Interrupted blind hole		
N	Aluminum - Wrought alloy	Not cureable	21	TTAL10	GS or AS	TTAL10	GS or AS	
		Cured	22	Vc = 150 - 400		Vc = 150 - 300		
	Aluminum-cast, alloyed	<=12% Si	Not cureable	23	B4 - B6	fz = 0.08 - 0.16	B4 - B6	fz = 0.07 - 0.15
			Cured	24				
		>12% Si	High temp.	25	B7 - B9	fz = 0.11 - 0.20	B7 - B9	fz = 0.11 - 0.20
	Copper alloys	>1% Pb	Free cutting	26	TT9030	AS	TT9030	AS
					Vc = 50 - 200		Vc = 50 - 200	
		Brass	27	B4 - B6	fz = 0.08 - 0.16	B4 - B6	fz = 0.08 - 0.16	
	Non-metallic		Electrolitic copper	28	B7 - B9	fz = 0.10 - 0.20	B7 - B9	fz = 0.10 - 0.20
			Duroplastics, fiber plastics	29	TT9030	AS	TT9030	AS
Vc = 25 - 80					Vc = 25 - 80			
Hard rubber			30	B4 - B6	fz = 0.05 - 0.10	B4 - B6	fz = 0.05 - 0.10	
	B7 - B9	fz = 0.10 - 0.20		B7 - B9	fz = 0.10 - 0.20			
S	High temp. alloys	Fe based	Annealed	31	TT9030	L *	TT9030	L *
			Cured	32	Vc = 15 - 50		Vc = 15 - 50	
		Ni or Co based	Annealed	33	B4 - B6	fz = 0.03 - 0.08	B4 - B6	fz = 0.03 - 0.08
			Cured	34				
			Cast	35				
	Titanium, Ti alloys	Alpha+beta alloys cured	36	B7 - B9	fz = 0.04 - 0.11	B7 - B9	fz = 0.04 - 0.11	
37								
H	Hardened steel	Hardened	38	TT9030	AS	TT9030	AS	
		Hardened	39	Vc = 25 - 50		Vc = 25 - 50		
	Chilled cast iron	Cast	40	B4 - B6	fz = 0.05 - 0.13	B4 - B6	fz = 0.05 - 0.13	
	Cast iron nodular	Hardened	41	B7 - B9	fz = 0.10 - 0.20	B7 - B9	fz = 0.10 - 0.20	

* Standard edge geometries are not suitable for reaming titanium and high temperature alloys.

In order to choose a proper geometry, please ask for our recommendations.

- The given cutting data recommendations refer to the short holders (3xD effective reaming overhang). For longer holders, the cutting speed to be reduced proportionally.
- For relatively large leading angles (spot-facing geometries), the feed to be reduced up to 30%.
- All the given cutting data recommendations refer to the machines with spindle through coolant supply.

Legend:

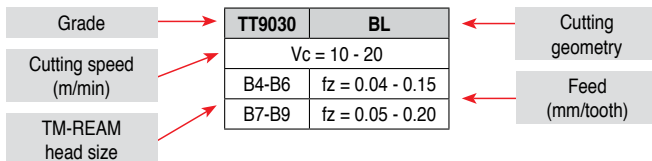

Recommended Cutting Conditions



Machining data for TB-REAM

			Lead A (15°/3°) (Reaming allowance: 0.1~0.3)						
			Feed (mm/rev)	Rake (°)	Cutting speed Vc (m/min)				
ISO	Material	Material No.			Carbide	Coated carbide	Cermet	PCD	CBN
P	Non-alloy steel and cast steel, free cutting steel	1 - 5	0.1-0.4	6	40-60	60-80	110-160		
	Low alloy steel and cast steel (Less than 5% of alloying elements)	6 - 9	0.1-0.4	6	20-40	40-60	110-160		
	High alloyed steel, cast steel and tool steel	10 - 11	0.1-0.4	6	20-40	20-60	20-60		
M	Stainless steel, cast steel	12 - 14	0.1-0.3	12	20-40	40-60	20-60		
K	Grey cast iron (GG)	15 - 16	0.1-0.3	0 / 6	40-60	60-100			Please ask
	Cast iron nodular (GGG)	17 - 18	0.1-0.3	0 / 6	40-60	60-100			
	Malleable cast iron	19 - 20	0.1-0.3	0 / 6	40-60	60-100			
N	Aluminum wrought alloy	21 - 22						Please ask	
	Aluminum-cast, alloyed	23 - 25							
	Copper alloys	26 - 28							
	Non-metallic	29 - 30							

			Lead C (75°) (Reaming allowance: 0.2~0.4)						
			Feed (mm/rev)	Rake (°)	Cutting speed Vc (m/min)				
ISO	Material	Material No.			Carbide	Coated carbide	Cermet	PCD	CBN
P	Non-alloy steel and cast steel, free cutting steel	1 - 5							
	Low alloy steel and cast steel (Less than 5% of alloying elements)	6 - 9							
	High alloyed steel, cast steel and tool steel	10 - 11							
M	Stainless steel, cast steel	12 - 14							
K	Grey cast iron (GG)	15 - 16							Please ask
	Cast iron nodular (GGG)	17 - 18							
	Malleable cast iron	19 - 20							
N	Aluminum wrought alloy	21 - 22	0.15-0.3	12	150-250			Please ask	
	Aluminum-cast, alloyed	23 - 25	0.15-0.3	12	150-250				
	Copper alloys	26 - 28							
	Non-metallic	29 - 30							

• The cutting conditions in the table below should be used to start a new application. Optimal conditions for a specific application should be evaluated by examining the results and changing the machining conditions accordingly.

• For more information of material groups, see the materials & grades "material conversion table"

■ Steel
 ■ Stainless steel
 ■ Cast iron
 ■ Nonferrous

Recommended Cutting Conditions

Machining data for TB-REAM

			Lead B (30°/3°) (Reaming allowance: 0.1 ~ 0.3)						
			Feed (mm/rev)	Rake (°)	Cutting speed Vc (m/min)				PCD
ISO	Material	Material No.			Carbide	Coated carbide	Cermet		
P	Non-alloy steel and cast steel, free cutting steel	1 - 5	0.1-0.4	6	60-80	80-120	110-160		
	Low alloy steel and cast steel (Less than 5% of alloying elements)	6 - 9	0.1-0.4	6	60-80	80-120	110-160		
	High alloyed steel, cast steel and tool steel	10 - 11	0.1-0.4	6	40-60	40-80	40-80		
M	Stainless steel, cast steel	12 - 14	0.1-0.3	12	40-60	60-80	60-80		
K	Grey cast iron (GG)	15 - 16	0.1-0.3	0 / 6	60-80	80-120			Please ask
	Cast iron nodular (GGG)	17 - 18	0.1-0.3	0 / 6	60-80	80-120			
	Malleable cast iron	19 - 20	0.1-0.3	0 / 6	60-80	80-120			
N	Aluminum wrought alloy	21 - 22		12	160-200			Please ask	
	Aluminum-cast, alloyed	23 - 25		12	160-200				
	Copper alloys	26 - 28		0	80-100				
	Non-metallic	29 - 30		0	10-70				

			Lead D (30°/3°) (Reaming allowance: 0.1 ~ 0.2)						
			Feed (mm/rev)	Rake (°)	Cutting speed Vc (m/min)				PCD
ISO	Material	Material No.			Carbide	Coated carbide	Cermet		
P	Non-alloy steel and cast steel, free cutting steel	1 - 5	0.1-0.4	6	60-80	80-120	110-160		
	Low alloy steel and cast steel (Less than 5% of alloying elements)	6 - 9	0.1-0.4	6	60-80	80-120	110-160		
	High alloyed steel, cast steel and tool steel	10 - 11	0.1-0.4	6	40-60	40-80	40-80		
M	Stainless steel, cast steel	12 - 14	0.1-0.3	12	40-60	60-80	60-80		
K	Grey cast iron (GG)	15 - 16	0.1-0.3	0 / 6	60-80	80-120			Please ask
	Cast iron nodular (GGG)	17 - 18	0.1-0.3	0 / 6	60-80	80-120			
	Malleable cast iron	19 - 20	0.1-0.3	0 / 6	60-80	80-120			
N	Aluminum wrought alloy	21 - 22		12	110-200			Please ask	
	Aluminum-cast, alloyed	23 - 25		12	160-200				
	Copper alloys	26 - 28		0	80-100				
	Non-metallic	29 - 30							

• The cutting conditions in the table below should be used to start a new application. Optimal conditions for a specific application should be evaluated by examining the results and changing the machining conditions accordingly.

• For more information of material groups, see the materials & grades "material conversion table"

■ Steel
 ■ Stainless steel
 ■ Cast iron
 ■ Nonferrous

► Chamfering ring designation - DRILL-RUSH

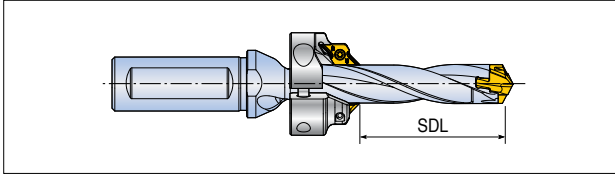

	Designation	CFR designation	SDL	
			min	max
3D	TCD 130-134-16T3/S0-3D	CFR D130-A45	19	19
	135-139-16T3/S0-3D	CFR D135-A45	19	20
	140-144-16T3/S0-3D	CFR D140-A45	21	22
	145-149-16T3/S0-3D	CFR D145-A45	22	23
	150-159-20T3/S0-3D	CFR D150-A45	23	23
	160-169-20T3/S0-3D	CFR D160-A45	24	25
	170-179-20T3/S0-3D	CFR D170-A45	26	28
	180-189-25T2/S0-3D	CFR D180-A45	27	30
	190-199-25T2/S0-3D	CFR D190-A45	29	33
	200-209-25T2/S0-3D	CFR D200-A45	30	36
	210-219-25T2/S0-3D	CFR D210-A45	32	39
	220-229-25T2/S0-3D	CFR D220-A45	33	42
	230-239-32T2/S0-3D	CFR D230-A45	35	45
240-249-32T2/S0-3D	CFR D240-A45	36	48	
250-259-32T2/S0-3D	CFR D250-A45	38	51	
5D	TCD 100-104-16T3/S0-5D	CFR D100-A45	28	28
	105-109-16T3/S0-5D	CFR D105-A45	29	30
	110-114-16T3/S0-5D	CFR D110-A45	31	33
	115-119-16T3/S0-5D	CFR D115-A45	32	35
	120-124-16T3/S0-5D	CFR D120-A45	33	45
	125-129-16T3/S0-5D	CFR D125-A45	34	40
	130-134-16T3/S0-5D	CFR D130-A45	36	43
	135-139-16T3/S0-5D	CFR D135-A45	37	43
	140-144-16T3/S0-5D	CFR D140-A45	38	48
	145-149-16T3/S0-5D	CFR D145-A45	39	48
	150-159-20T3/S0-5D	CFR D150-A45	41	53
	160-169-20T3/S0-5D	CFR D160-A45	43	58
	170-179-20T3/S0-5D	CFR D170-A45	46	63
	180-189-25T2/S0-5D	CFR D180-A45	48	68
	190-199-25T2/S0-5D	CFR D190-A45	51	73
	200-209-25T2/S0-5D	CFR D200-A45	53	78
	210-219-25T2/S0-5D	CFR D210-A45	56	79
220-229-25T2/S0-5D	CFR D220-A45	58	84	
230-239-32T2/S0-5D	CFR D230-A45	61	89	
240-249-32T2/S0-5D	CFR D240-A45	63	94	
250-259-32T2/S0-5D	CFR D250-A45	66	99	

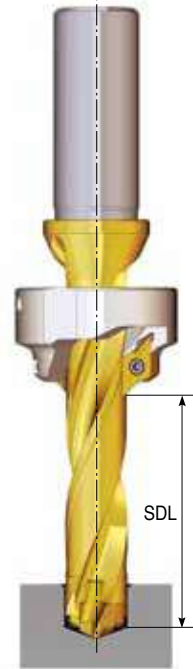

► Chamfering ring designation - DRILL-RUSH

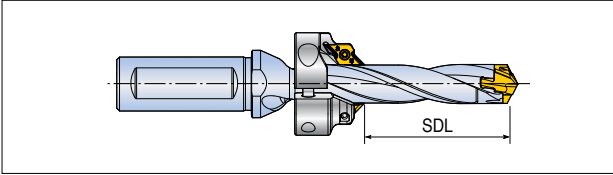

	Designation	CFR designation	SDL	
			min	max
8D	TCD 100-104-16T3/S0-8D	CFR D100-A45	45	58
	105-109-16T3/S0-8D	CFR D105-A45	49	62
	110-114-16T3/S0-8D	CFR D110-A45	49	66
	115-119-16T3/S0-8D	CFR D115-A45	53	70
	120-124-16T3/S0-8D	CFR D120-A45	53	74
	125-129-16T3/S0-8D	CFR D125-A45	57	78
	130-134-16T3/S0-8D	CFR D130-A45	57	82
	135-139-16T3/S0-8D	CFR D135-A45	61	84
	140-144-16T3/S0-8D	CFR D140-A45	61	88
	145-149-16T3/S0-8D	CFR D145-A45	65	92
	150-159-20T3/S0-8D	CFR D150-A45	65	96
	160-169-20T3/S0-8D	CFR D160-A45	69	103
	170-179-20T3/S0-8D	CFR D170-A45	73	111
	180-189-25T2/S0-8D	CFR D180-A45	77	118
	190-199-25T2/S0-8D	CFR D190-A45	81	126
	200-209-25T2/S0-8D	CFR D200-A45	85	134
	210-219-25T2/S0-8D	CFR D210-A45	89	142
	220-229-25T2/S0-8D	CFR D220-A45	93	150
230-239-32T2/S0-8D	CFR D230-A45	97	158	
240-249-32T2/S0-8D	CFR D240-A45	101	166	
250-259-32T2/S0-8D	CFR D250-A45	105	174	
12D	TCD 120-124-16S0-12D	CFR D120-A45	87	121
	125-129-16S0-12D	CFR D125-A45	90	127
	130-134-16S0-12D	CFR D130-A45	93	133
	135-139-16S0-12D	CFR D135-A45	96	137
	140-144-16S0-12D	CFR D140-A45	99	143
	145-149-16S0-12D	CFR D145-A45	102	149
	150-159-20S0-12D	CFR D150-A45	105	155
	160-169-20S0-12D	CFR D160-A45	111	166
	170-179-20S0-12D	CFR D170-A45	117	178
	180-189-25S0-12D	CFR D180-A45	123	189
	190-199-25S0-12D	CFR D190-A45	129	201
	200-209-25S0-12D	CFR D200-A45	135	213
	210-219-25S0-12D	CFR D210-A45	141	225
	220-229-25S0-12D	CFR D220-A45	147	237

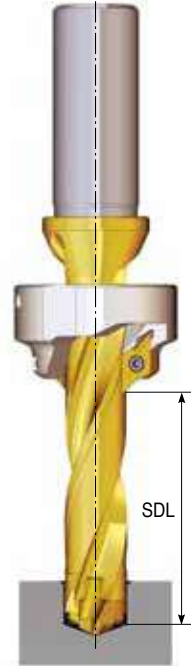

► Modular head replacement instructions

1. Remove both outer inserts, then remove the center drill head.
(When clamping, go in the reverse order)



2. Use a wrench to turn the screw counter-clock-wise to remove the modular head.

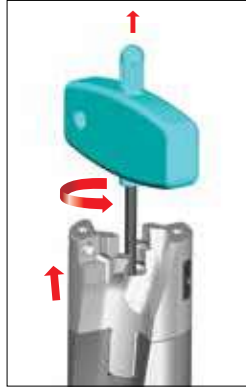

3. Insert the setting gauge into the bottom of the disconnected modular head.



4. Rotate the screw to adjust to the same height with the setting gauge.

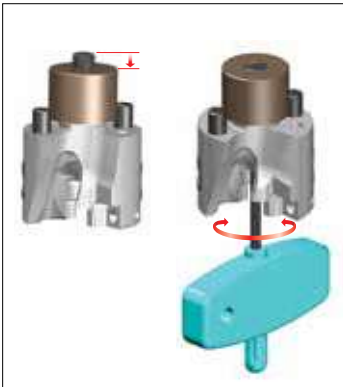

5. Remove the height adjusted modular head from the setting gauge and attach it to the holder.

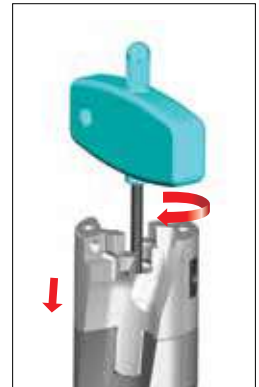

Setting gauge

Drill dia.	Designation
D26-D29	SG TNDH D26-29-TP
D30-D35	SG TNDH D30-35-TP
D36-D39	SG TNDH D36-39-TP
D40-D43	SG TNDH D40-43-TP
D44-D50	SG TNDH D44-50-TP

► Modular head disassembly in the event of center drill damage

If the modular head cannot be unclamped due to center drill damage, insert the wrench into the rear section of the shank. Then, turn it clock-wise to disassemble the modular head.

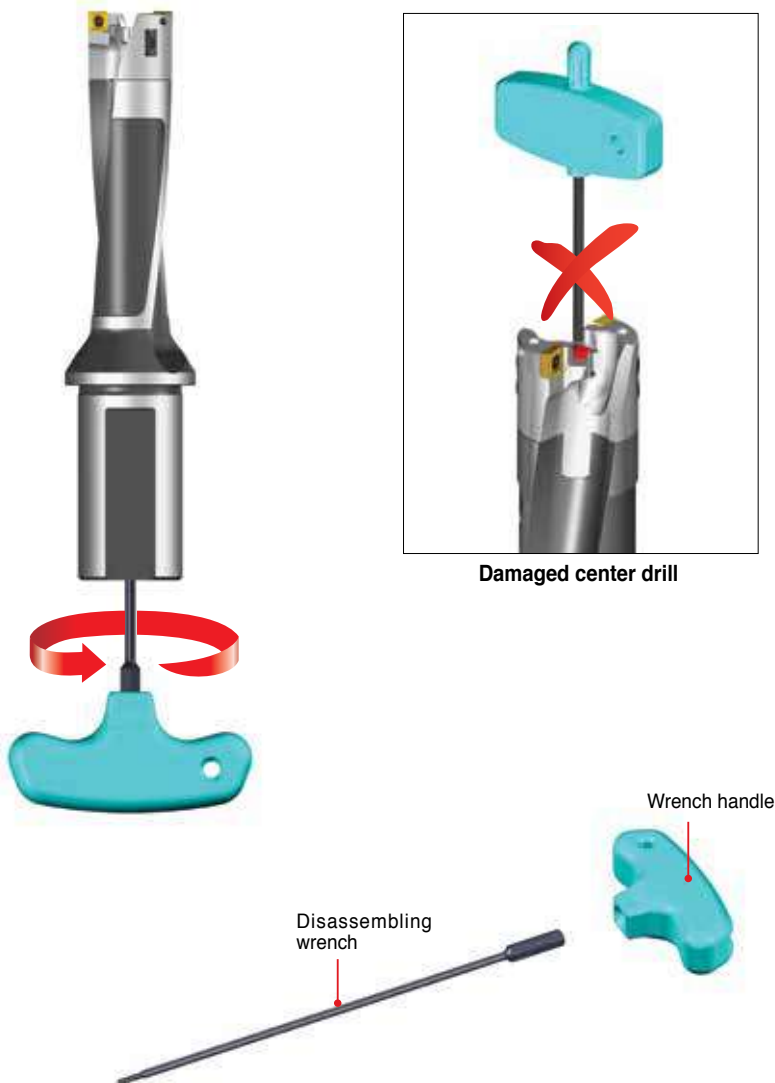

- Disassembling wrench and handle are included with the modular drill holder. (MDB Dxx/xx...)

Technical Data

► Hole tolerance

Diameter D(mm)		Tolerance (µm)															
>D	≤D	B10	C9	C10	D8	D9	D10	E7	E8	E9	F6	F7	F8	G6	G7	H6	H7
-	3	+180 +140	+85 +60	+100 +60	+34 +20	+45 +20	+60 +20	+24 +14	+28 +14	+39 +14	+12 +6	+16 +6	+20 +6	+8 +2	+12 +2	+6 0	+10 0
3	6	+180 +140	+100 +70	+118 +70	+48 +30	+60 +30	+78 +30	+32 +20	+38 +20	+50 +20	+18 +10	+22 +10	+28 +10	+12 +4	+16 +4	+8 0	+12 0
6	10	+208 +150	+116 +80	+138 +80	+62 +40	+76 +40	+98 +40	+40 +25	+47 +25	+61 +25	+22 +13	+28 +13	+35 +13	+14 +5	+20 +5	+9 0	+15 0
10	14	+220 +150	+138 +95	+165 +95	+77 +50	+93 +50	+120 +50	+50 +32	+59 +32	+75 +32	+27 +16	+34 +16	+43 +16	+17 +6	+24 +6	+11 0	+18 0
14	18																
18	24	+244 +160	+162 +110	+194 +110	+98 +65	+117 +65	+149 +65	+61 +40	+73 +40	+92 +40	+33 +20	+41 +20	+53 +20	+20 +7	+28 +7	+13 0	+21 0
24	30																
30	40	+270 +170	+182 +120	+220 +120	+119 +80	+142 +80	+180 +80	+75 +50	+89 +50	+112 +50	+41 +25	+50 +25	+64 +25	+25 +9	+34 +9	+16 0	+25 0
40	50	+280 +180	+192 +130	+230 +130													
50	65	+310 +190	+214 +140	+260 +140	+146 +100	+174 +100	+220 +146	+90 +60	+106 +60	+134 +60	+49 +30	+60 +30	+76 +30	+29 +10	+40 +10	+19 0	+30 0
65	80	+320 +200	+224 +150	+270 +150													

Technical Data

► Hole tolerance

Tolerance (μm)																	
H8	H9	H10	JS6	JS7	K6	K7	M6	M7	N6	N7	P6	P7	R7	S7	T7	U7	X7
+14 0	+25 0	+40 0	± 3	± 5	0 -6	0 -10	-2 -8	-2 -12	-4 -10	-4 -14	-6 -12	-6 -16	-10 -20	-14 -24	-	-18 -28	-20 -30
+18 0	+30 0	+48 0	± 4	± 6	+2 -6	+3 -9	-1 -9	0 -12	-5 -13	-4 -16	-9 -17	-8 -20	-11 -23	-15 -27	-	-19 -31	-24 -36
+22 0	+36 0	+58 0	± 4.5	± 7.5	+2 -7	+5 -10	-3 -12	0 -15	-7 -16	-4 -19	-12 -21	-9 -24	-13 -28	-17 -32	-	-22 -37	-28 -43
+27 0	+43 0	+70 0	± 5.5	± 9	+2 -9	+6 -12	-4 -15	0 -18	-9 -20	-5 -23	-15 -26	-11 -29	-16 -34	-21 -39	-	-26 -44	-33 -51 -38 -56
+33 0	+52 0	+84 0	± 6.5	± 10.5	+2 -11	+6 -15	-4 -17	0 -21	-11 -24	-7 -28	-18 -31	-14 -35	-20 -41	-27 -48	-	-33 -54	-46 -67 -56 -77
+39 0	+62 0	+100 0	± 8	± 12.5	+3 -13	+7 -18	-4 -20	0 -25	-12 -28	-8 -33	-21 -37	-17 -42	-25 -50	-34 -59	-	-39 -64 -45 -70	-51 -76 -61 -86
+46 0	+74 0	+120 0	± 9.5	± 15	+4 -15	+9 -21	-5 -24	0 -30	-14 -33	-9 -39	-26 -45	-21 -51	-30 -60 -32 -62	-42 -72 -48 -78	-55 -85 -64 -94	-76 -106 -91 -121	-

► Specific dimensions

Through Blind

ØD1 _____ L1 _____

α1 _____ S _____

•Hole tolerance _____

Through Blind

ØD1 _____ ØD2 _____

L1 _____ L2 _____

α1 _____

•Hole tolerance _____

Through Blind

ØD1 _____ ØD2 _____

L1 _____ L2 _____

α1 _____ α2 _____

S _____

•Hole tolerance _____

Comment

Drill type

- TOPDRILL _____
- T-DRILL _____

Technical data

- Machine type
- MCT Lathe
- Vertical Horizontal
- Machine name _____
- Power _____ kW

- Coolant supply
- Internal External
- Coolant pressure _____ bar
- Coolant type _____

Workpiece

- Part _____
- Material _____
- Hardness _____

Shank type

- Cylindrical shank (ISO 9766)
- Whistle notch shank
- Cylindrical with flat type
- Weldon shank

► Specific dimensions

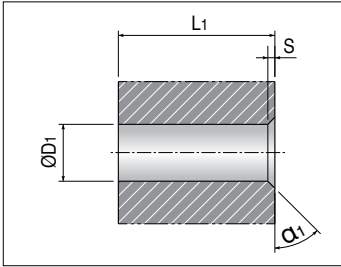

Through Blind

ØD1 _____ L1 _____

α1 _____ S _____

•Hole tolerance _____

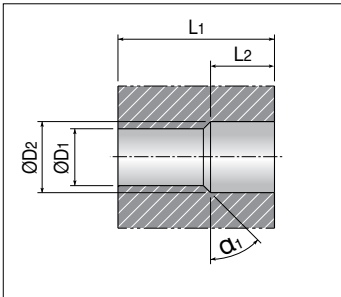

Through Blind

ØD1 _____ ØD2 _____

L1 _____ L2 _____

α1 _____

•Hole tolerance _____

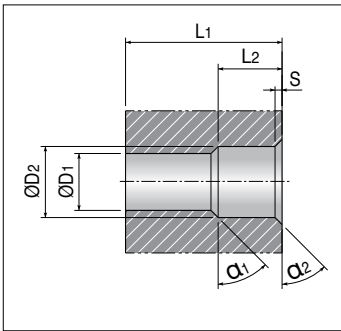

Through Blind

ØD1 _____ ØD2 _____

L1 _____ L2 _____

α1 _____ α2 _____

S _____

•Hole tolerance _____

Comment

Technical data

•Machine type
 MCT Lathe
 Vertical Horizontal
 Machine name _____
 Power _____ kW

•Coolant supply
 Internal External
 Coolant pressure _____ bar
 Coolant type _____

Workpiece

•Part _____
 •Material _____
 •Hardness _____

Shank type

Cylindrical shank (ISO 9766)

Whistle notch shank

Cylindrical with flat type

Weldon shank

•Shank dia: _____
 •Shank length: _____

► Specific dimensions

• DC, DC_2 would be hole dimensions and please note hole tolerance if possible

Technical data

- Machine type
 MCT Lathe
 Vertical Horizontal
- Machine name _____
- Power _____ kW
- Coolant supply
 Internal External
- Coolant pressure _____ bar
- Coolant type _____

Workpiece

- Part _____
- Material _____
- Hardness _____

Hole type

- Blind hole
- Through hole

Coating

- TiAIN
- Non-coated

Shank type

- Cylindrical shank
- Whistle notch shank
- Cylindrical with flat type
- Weldon shank

Comment

Tailor-made Order Form



► Deep hole drilling order form

★: Mandatory data field

Company name :	Inquiry number :
Address :	Inquiry date :
Contact person :	Customer No. :

Workpiece (If possible, please attach a drawing)	
Product name	
Hole diameter (ø)	(mm)
Hole depth (drilling length)	(mm)
No. of holes	
Tolerance (of hole)	
Surface finish (Rz, Ra...)	
Deviation (mm/100)	
Straightness (mm/100)	
Material	
Material (DIN, AISI, JIS...)	
Hardness (HB, HS, HRC...)	
Condition★	<input type="checkbox"/> Annealed <input type="checkbox"/> Quenched <input type="checkbox"/> Tempered <input type="checkbox"/> Cast <input type="checkbox"/> <input type="checkbox"/> Other <input type="checkbox"/>

Machine	
Machine supplier name	
Machine type/model	
Rigidity	<input type="checkbox"/> Good <input type="checkbox"/> Normal <input type="checkbox"/> Bad
Date of manufacture	
Retrofitted	<input type="checkbox"/> NC lathe <input type="checkbox"/> M/C <input type="checkbox"/> Other
Double rotation (TR/WR)	<input type="checkbox"/> Tool and workpiece
Rotating workpiece (WR)	<input type="checkbox"/>
Rotating tool (TR)	<input type="checkbox"/>
Safety devices	
Motor power	(kW)

Type of coolant	
Coolant supplier name	
Water based	<input type="checkbox"/> Soluble <input type="checkbox"/> Emulsion %
Oil based	<input type="checkbox"/>
Coolant pressure	(bar)
Coolant volume	(L/min)

► Deep hole drilling order form

*: Mandatory data field

Tool (Drill head)	
Drill diameter(ϕ)	(mm)
Thread	<input type="checkbox"/> Inner <input type="checkbox"/> Outer
Brazed	<input type="checkbox"/>
Indexable	<input type="checkbox"/> Adjustable <input type="checkbox"/> Direct mount <input type="checkbox"/>
Coating	<input type="checkbox"/> Coated <input type="checkbox"/> Uncoated
Coating type	<input type="checkbox"/> TiN <input type="checkbox"/> TiAlN <input type="checkbox"/> Other
• Solid drilling	<input type="checkbox"/>
• Counterboring	<input type="checkbox"/>
Cutting angle *	<input type="checkbox"/> 20° <input type="checkbox"/> 45°
Brazed indexable	<input type="checkbox"/> Nomal angle <input type="checkbox"/> Close angle
Pre-bored size(per side)	(mm)
Bottom finishing *	<input type="checkbox"/> Fullball R <input type="checkbox"/> Flatbottom R <input type="checkbox"/> Corner R <input type="checkbox"/> Compound R
• Trepanning	<input type="checkbox"/>
Core size(ϕ)	(mm) <input type="checkbox"/>
Tube inner dia(ϕ)	(mm)
Tube outer dia(ϕ)	(mm)
Tube	
Outside dia(ϕ)	(mm)
Total length(L)	(mm)
Internal thread	<input type="checkbox"/>
External thread	<input type="checkbox"/> 4 Starts <input type="checkbox"/> 2 Starts <input type="checkbox"/> 1 Starts
Tube thread	<input type="checkbox"/> 1 end <input type="checkbox"/> Both ends
Inner tube length	(mm)
Inner tube slit	<input type="checkbox"/> 1 end <input type="checkbox"/> Both ends
Drilling system	
Single tube system	<input type="checkbox"/> STS
Double tube system	<input type="checkbox"/> DTS
Boring conditions	
Through hole drilling	<input type="checkbox"/>
Blind hole drilling	<input type="checkbox"/>
Cross hole drilling *	<input type="checkbox"/>

* Please sketch your drilling application

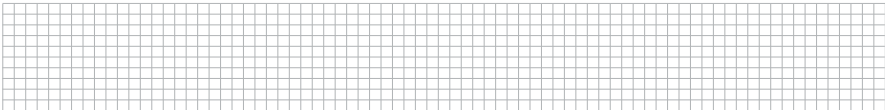

General information		Production	
Quantity per year:			
Present performance status:			
grade, tool life, etc:			
Cutting data:	Vc=	m/min,	N=
	f=	mm/rev,	F=
			rpm
			mm/min

► Deep hole drilling order form

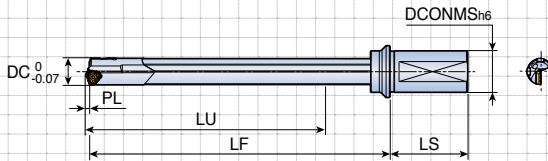

Sketch of drilling application

• Note: It may be necessary to change several of the parameters that you indicated based on our experience with your application.

Tool

Quantity

Nominal diameter and tolerance

- Please fill in dimensions on the sketch above.

Driver

Code No

- For standard drivers, please use codes from next pages and for special drivers, please attach sketch and specifications.

Workpiece

(If possible, please attach a drawing)

Material description

(DIN material number or any other standard)

Hardness and properties

Hole type

Blind hole Through hole Drilling into pre-hole
 Angled entry Drilling into solid Boring
 Angled exit

Drilling depth mm

Hole tolerance

Application

Workpiece	<input type="checkbox"/> Stationary	<input type="checkbox"/> Rotating
Tool	<input type="checkbox"/> Stationary	<input type="checkbox"/> Rotating

Machine

Machine type

Power kW

Cutting data

Cutting speed (Vc)	m/min		
Revolutions	Nmin :	RPM	Nmax : RPM
Feed	Fmin :	mm/rev	Fmin : mm/rev
Feed rate (VF)	mm/min		

Coolant

Coolant type	<input type="checkbox"/> Oil	<input type="checkbox"/> Soluble oil	<input type="checkbox"/> Other
Coolant pressure	Bar		
Coolant volume	liter/min		

► Standard gundrill drivers for machining centers and lathes

Drivers

Drivers are available for dedicated and CNC machines as well as any specified diameter or length. Please note that the driver codes and technical data can be found in the chart below.

Driver type	Drawing	DCONMS x LS	Driver code
Cylindrical DIN1835A DIN6535HA		20x50	10
		25x56	11
		32x60	12
		40x70	13
		.75x2.03"	95
		1.00x2.28"	96
		1.25x2.28"	97
Weldon DIN1835B DIN6535HB		20x50	22
		25x56	23
		32x60	24
		40x70	25
		.75x2.03"	99
		1.00x2.28"	100
Whistle notch DIN1835E		20x50	34
		25x56	35
		32x60	36
		40x70	37

► Standard drivers for gundrill machines

Driver type	Drawing	DCONMS x LS	Driver code
DIN228AK		CM2	46
		CM3	47
		CM4	48
DIN228BK		CM2	50
		CM3	51
		CM4	52
Central clamping surface 15°		.750x2.75"	56
		25x70	57
		1.00x2.75"	58
		1.25x2.75"	59
		1.50x2.75"	60
Frontal clamping surface 15°		16x50	61
Cylindrical with thread		25x100 M16x1.5	66
		36x120 M24x1.5	67
VDI design		25x112 M16x1.5	70
		36x135 M24x1.5	71
Central clamping hexagonal		25x70	72
		32x70	73
Central clamping tapered		.75x2.75"	76
		20x70	77
Frontal clamping surface 2°		1.00x2.75"	80
		1.00x3.94"	81
		1.25x2.75"	82
		1.25x3.94"	83
		1.50x2.75"	84
		1.50x3.94"	85
Trapezoidal thread		28x126 Tr 28x2	88
		36x162 Tr 36x2	89
Spraymist driver		25x50	91
		35x60	92

▶ Reamer order form









★ : Mandatory data field

Date:	Subsidiary:
Company ★ :	Enquiry dead line:
Contact person:	
Address:	

Request reason	
New tool <input type="checkbox"/>	Problem <input type="checkbox"/>
Quality	
Cycle time	
Alternative supplier	
Other	

Existing tool	
Maker	
Tool type	
Speed & Feed	
Tool life	
No of teeth	
Coolant type	

Machine	
Model	
Type ★	vertical <input type="checkbox"/>
	horizontal <input type="checkbox"/>
	multi-spindle <input type="checkbox"/>
Adaption ★	
Max RPM	
Power	
Spindle accuracy	
Coolant	

Workpiece	
Description ★	
Hardness ★	
Pre-hole size ★	(Tolerance :)
Depth ★	
Bore type	
<input type="checkbox"/>  <input type="checkbox"/>  <input type="checkbox"/>  <input type="checkbox"/>  <input type="checkbox"/> 	
<input type="checkbox"/>  <input type="checkbox"/>  <input type="checkbox"/>  <input type="checkbox"/> 	
Clamping information	

Lubricant	
Oil	<input type="checkbox"/>
MQL	<input type="checkbox"/>
Emulsion	<input type="checkbox"/>
Ratio of mixture	
Coolant pressure	

Quality requirement	
Tolerance ★	
Surface finish(Ra) ★	
Roundness	
Straightness	
Cylindricity	
Concentricity	

Tool	
Type ★	TM(Index multi-edge) <input type="checkbox"/> TB(Single blade) <input type="checkbox"/> TS(Solid) <input type="checkbox"/> Other <input type="checkbox"/> ()
Diameter ★	
Depth of cut ★	
Coolant ★	Internal <input type="checkbox"/> External <input type="checkbox"/>
Shank type ★	
Holder type	Collet <input type="checkbox"/> Hydraulic <input type="checkbox"/> Other <input type="checkbox"/>
Adjustable adaptor	Yes <input type="checkbox"/> No <input type="checkbox"/>

MATERIALS & GRADES

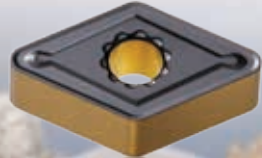
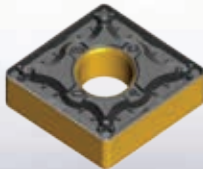
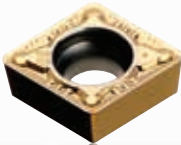

Grade Comparison Table

▶ Turning grades

ISO class	TaeguTec	Sandvik	Walter	Seco	Kennametal	MMC	Sumitomo	Tunggaloy	Kyocera	Korloy	Iscar
P	TT8105B	GC4305	WPP05S WPP05	TP0501 TP0500	KCP05	UE6105 UE6005	AC810P	T9205 T9105	CA510 CA5505		
	TT8115B	GC4415 GC4315	WEP10C WPP10S WPP10 WPV10	TP1501 TP1500	KCP10 KCP10B	MC6015 UE6110	AC8015P AC820 AC1000	T9215 T9115	VP5115 CA515 CA5515 PR1705	NC3215 NC3010	IC8150 IC9150
	TT8125B TT5100 TT9080	GC4425 GC4325 GC1525	WPP20S WMP20S WPV20	TP2501 TP2500	KCP25 KCP25B	MC6025 UE6020	AC8025P AC2000 AC1030U ACZ150 AC5005S AC5025S AC520U	T9225 T9125 AH7025	CA025P VP5125 CA525 CA5525 PR930 PR1025 PR1725	NC3225 NC3220 NC5330 NC3120 PC5300	IC8250 IC9250
	TT8135B TT7100	GC4335	WPP30S WPP30	TP3501 TP3500	KCP30 KCP40	MC6035 UH6400	AC8035P AC830P AC3000	T9235 T9135	CA530 CA5535 PR1535	NC500H NC5340 NC5350 NC3030 PC5400	IC8350 IC9350
M	TT9215 TT5080	GC2015 GC1115	WSM01 WSM10 WSM10S WAM10	TM1501 TM2000 TH1000 TS2000 TS2050 CP200	KCM15B KCM15 KCU10 KCS10 KC5510 KC5010	MC7015 US7020 VP10RT	AC6020M AC610M AC5015S AC510U ACZ150 AC520U	T6120 AH110 AH120	KX409 CA6515 PR930	NC9115 NC9020 PC8105 PC8110	IC6015 IC807 IC804
	TT9225 TT9080	GC2025 GC2220 GC1125	WMP20S WSM20 WSM21	TM2501 TS2500 CP500	KCM25B KCM25 KCU25 KC5525 KC5025	MC7025 US735 MH515 VP15TF VP20MF VP20RT UP20M	AC6030M AC630M AC5025S AC6040M AC1030U AC530U	T6130 AH630 AH725 AH7025	CA6525 PR1025 PR1125 PR1225 PR1425 PR1725	NC9125 NC5330 NC5340 PC8115 PC5300 PC9030	IC6025
	TT9235 TT8080 TT8020	GC2035 GC30	WSM30 WAM30	TM3501 TM4000 CP600	KCM35B KCM35	MP7035 UH6400 MP7035	AC6040M	AH6030 T6030 AH645	PR1325 PR1535	NC9135 NC5350 PC5400	IC5400 IC3028
K	TT7005	GC3205 GC3005	WKK10S WAK10	TK0501 TK1001 TK1000	KCK05	MC5005 UC5105	AC405K	T5105 T5010	CA310 CA4505 CA4010	NC6310 NC6205 NC6105	IC5005 IC4028
	TT7015	GC3210 GC3015	WKK20S WAK20	TK1501 TK2001 TK2000	KCK15 KCK15B	MC5015 UC5115	AC410K AC415K	T5115 T5020 T515	CA315 CA4515 CA4115	NC6315 NC6210 NC6110	IC5010
	TT7025	GC3215 GC3225	WAK30		KCK20B KCK20	MH515	AC420K	T5125	CA320 CA4120	NC6215	
S H	TT3005 TT5080 TT3010	S05F GC1105	WSM01	CP200 CP250 TH1000 TH1500 TS2000 TS2500	KCU10 KCS10 KCS10B KC5510 KC5010	MV9005 US905 MP9005 MP9015 VP05RT VP10RT	AC5015S AC510U ACZ150	AH8005 AH110 AH905 AH8015	PR1305	PC8105 PC8110	IC807 IC806 IC1007 IC907
	TT3020 TT9080 TT8080	GC1115 GC15 GC1515 GC1125 GC1525 GC1135 S205	WSM10 WSM10S WSM21 WSM20 WSM20S WSM30 WSM30S	TS2500 CP500 CP600	KCU25 KCU30 KC5525 KC5025	VP15TF VP20RT MP9025	AC520U AC5025S AC6040M AC1030U AC530U	AH9030 AH120 AH725 SH730 AH7025 AH6030	PR1310 PR005S PR015S PR1125 PR1325 PR1535	PC8115 PC5300 PC5400	IC808 IC908

Grade Comparison Table

▶ Miniature turning grades

ISO class	TaeguTec	ARNO	Diametal	Kyocera	NTK	Tungaloy	Sumitomo
P	TT4410 TT4430 TT9020	AM5015 AM5025 AM5020 AM5120 AM5120+	D60 D30 D10	PR1705 PR1725 PR1425 PR1005 PR1025 PR1115 PR1225 PR930 PR1535	VM1 DM4 DT4 TM4 ZM3 QM3 CP7	AH710 SH725 SH730 AH725 AH7025 AH730 AH9030 AH120 AH130 AH3135	ACZ150 AC5015S AC5025S AC530U AC1030U
M	TT4410 TT4430 TT9020	AM5110 AN5015 AM5025 AM5020 AM5120 AM5120+ AM5220 AM5130	D60 D30 D20 D10	PR1705 PR1725 PR1425 PR1025 PR1125 PR1225 PR930 PR1535	ST4 VM1 DM4 DT4 TM4 ZM3 QM3	AH710 SH725 AH725 AH120 AH130	ACZ150 AC5015S AC5025S AC530U AC1030U
S	TT4410 TT4430 TT9020	AM5110 AM5015 AM5025 AM5120 AM5120+ AM5220 AM5130	D60 D30 D20	PR1305 PR1310 PR1325 PR1125 PR1535	DM4 DT4 TM4 QM3 ZM3	AH905 AH8005 AH8015 AH110 SH730 AH725 AH120	ACZ150 AC5015S AC5025S AC530U AC1030U

Grade Comparison Table

▶ Parting & Grooving Grades

ISO class	TaeguTec	Sandvik	Walter	Seco	Kennametal	MMC	Sumitomo	Tungaloy	Kyocera	Korloy	Iscar
P	TT5100 TT9080 TT9030 TT4430 TT9010 TT7220 TT8020	GC3115 GC4325 GC4225 GC1125 GC2135 GC1135 GC1145	WSM13S WKP23S WSM23S WKP33S WSM33S WSM43S	CP200 TGP25 TGP35 KCP25B TGP45 T25M T350M CP500 CP600	KCP10 KCP10B KCP25 KCP25B KC9110 KC9125 KCU10 KCU25 KCM35B	MY5015 VP10RT VP20RT RT9010 RT9020	AC830P AC530U ACZ150 AC510U AC520U	GH130 AH725 T9215 AH725 AH7025 SH730 GH730 T9530 AH710 J740 TX10S UX30	PR915 PR1115 PR1215 CR9025 PR1025 PR1225 PR1625 PR930 PR630 PR660 PR1535	A30 NC3020 NC3120 NC3225 NC3030 NC5330 NC9025 PC3535 PC5300 PC9300 PC230	IC907, IC507 IC1007 IC9015, IC9025, IC9054 IC807(907) IC808(908) IC1008 IC8250 IC250(950) IC5400 IC354, IC328 IC830(928) IC228
M	TT5100 TT3010 TT9080 TT9030 TT4430 TT9010 TT7220 TT8020	H13A GC1005 GC1105 GC1125 GC2135 GC1135 GC1145	WSM13S WSM23S WSM33S WSM43S	CP200 TGP25 TGP35 TGP45 T25M T350M 890 CP500 HX 883 CP600	K313 KCU10 KC5010 KCU25 KC5025 KCM35B	VP10RT VP20RT	ACZ150 AC510U AC520U AC530U AC6040M	GH130 AH725 SH725 SH7025 SH730 GH730 J740 AH710	PR915 PR1115 PR1215 CR9025 PR1025 PR1225 PR930 PR630 PR660 PR1535	NC9025 NC5330 PC9030 PC5300	IC1007 IC807 IC907 IC808(908) IC1008 IC8250 IC5400 IC1028(830,928) IC354, IC328 IC228
K	K10 TT7505 TT6080 TT9080 TT9030 TT9010	H13A GC3115 GC4225 GC1125 GC1025 GC1125 GC1135	WTA33 WKP13S WAK20 WKP23S WAK30 WKP33S WPP23	TGH1050 TGK1500 CP200 890 HX TGP25 TGP35 TGP45 883 CP500 CP600	K313 KCU10 KCP25B KCU25	MY5015 VP10RT VP20RT	G10E AC510U AC520U AC530U AC425K	GH130 AH725 AH710 SH730 GH730 TH10	PR905 KW10 GW15 PR1215	NC5330 PC5300 A30 NC6110 PC9030 PC215K PC6510	IC20 IC1007 IC5010 IC428, IC418 IC807, IC907 IC808(908) IC8250 IC250(950) IC228
N	K10 TT9080 TT9030 TT9010	H13A GC1005 GC1105 GC1115 GC1025	WK1	890 883 HX	K313 KCU10 KC5010 KCU25 KCM35B	RT9010 RT9020	ACZ150 G10E AC530U	TH10 KC05F KS05F SH725 SH730	KW10 GW15 PDL025	G10E H01 A30 PC215K	IC20 IC08 IC228 IC28
S	K10 TT3010 TT9080 TT9030 TT4430 TT9010 TT8020	GC1005 GC1105 GC1115 GC1025 GC1145	WSM13S WSM23S WSM33S WSM43S	TGH1050 890 CP200 HX CP500 883 CP600	K313 KCU10 KC5010 KCU25 KC5025	RT9010 RT9020 VP10RT VP20RT	AC425K G10E AC1030U	AH905 GH130 AH725 AH7025 SH725 SH730 TH10	KW10 GW15	PC5300	IC804 IC806 IC1007 IC807, IC907 IC07 IC20 IC08 IC808(908) IC1008 IC830(928)
H	TT6080		WAK20	TGH1050 T350M HX CP200 890 883	KCU10 KCU25		H10				IC1007 IC807, IC907 IC808(908)

Grade Comparison Table

► Cermet grades

ISO class	TaeguTec	Sandvik	Kennametal	Sumitomo	Kyocera	Tungaloy	Mitsubishi	Korloy	Seco	NTK	Ceramtec
P01	PV3010		KT315	T110A T1000A T1500Z	PV720 PV710 PV7040 CCX	GT720 NS710	AP25N NX1010 NX252	CC105 CC115 CN1000		T3N	SC35
P10	CT3000	CT5005 CT5015 CT525 GC1525	KT5020 KT125 KT150	T1500A T1200A T2000Z	TN60 TN610 TN620 TC40N	GT730 GT530 NS520 NS720	MP3025 UP35N	CN1500 CN2000 CC125	TP1030 CMP CM	T15 C30 Q50	SC15 SC8015 SC7035 SC40
M01	PV3010		KT315		PV30 TN30 PV7010	GT720 NS710	AP25N NX2525	CC105 CC115 CN1000		T3N	SC35
M10	CT3000	CT5005 CT5015 CT525 GC1525	KT5020 KT125 KT150	T1500A	PV7020 PV60 TN6010 TN6020 TN60	GT730 GT530 NS520 NS720	MP3025 UP35N	CN2000 CC125	TP1030 CMP CM	T15 C30 Q50	SC15 SC8015 SC7035 SC40
K10	CT3000	CT5015	KT125		TN60 TN6020	GT730 NS730 NS530		CN2000	C15M	T15 Z15 C7Z	SC7015

Grade Comparison Table

► Ceramic grades

ISO class	Composition	TaeguTec	Sandvik	Kennametal	Ceramtec	NTK	Kyocera	Sumitomo	Tungaloy
K	Al ₂ O ₃ , ZrO ₂	AW120	CC620		SN60 SN80	HC1 HW2	KA30		TZ120
	Al ₂ O ₃ , TiC	AB30	CC650	KY1615	SH2 SH4	HC2 HC5 HC6	A65	NB90S NB90M	LX21
	Si ₃ N ₄ , Al ₂ O ₃ , Y ₂ O ₃ , AlN	AS500		KY1310 KY3000	SL506 SL508 SL606 SL608	SX9			
	Si ₃ N ₄ , ZrO ₂ , Al ₂ O ₃ , Y ₂ O ₃	AS10	CC6090 CC6190	KY1320 KY3500 KYK10	SL500 SL808	SX1 SX6 SX8	KS6000 KS6050	SN2000K SN2100K NS260	FX105 CX710
	CVD coated	SC10	CC1690	KY3400 KYK25	SL550C SL554C SL654C SL658C SL854C SL858C	SP2 SP9	CS7050	NS260C	CXC73
H	Al ₂ O ₃ , TiCN	AB20			SH2 SH4	HC2 HC5 HC7			LX10
	PVD coated	AB2010	CC6050	KY4400		ZC4 ZC7	A66N PT600M	NB100C	LX11
S	Al ₂ O ₃ , SiC whisker	TC430	CC670	KY4300		WA1 WA5		WX2000	
	Si ₃ N ₄ , TiN	TC3020 TC3030	CC6060 CC6065 CC6160	KY2100 KY1540 KYS30 KYS25 KYS30P		SX3 SX5 SX7 SX9	KS6030 KS6040	SN1000S SN2000S	TS200 TS300

Grade Comparison Table

► CBN grades

ISO class	TaeguTec	Iscar	Tungaloy	Sumitomo	Sandvik	Kennametal	Mitsubishi	Kyocera	Seco
H	TB610	IB10H IB50	BX310	BN1000 BNX1	CB7105 CB7015	KB1610	MBC010	KBN510	CBN10
		IB10HC	BXC30 BXA30	BNC80 BNC100 BNC2010		KB5610 KB9610	MB8025 BC8105 BC8210	KBN10M KBN10C KBN25C	CBN050C CH0550
	TB2015 TB650	IB20H IB55	BX330 BX530	BN250 BN2000 BNX20	CB7115 CB7025	KB1625	MB810	KBN525	CBN100
		IB25HA	BXM10 BXC30 BXA40	BNC160 BNC2020		KB5625	MB820 BC8110 BC8220	KBN05M KBN25M	CBN160C CH2540
	TB670	IB25HC	BX360 BX380	BNX25 BN350	CB7125 CB7135 CB50 CB7525 CB7925		MB825 MB8025 BC8120 BC8220		CBN150 CBN170
			BXM20 BXA20 BXA40 BXC50	BNC200 BNC300			MB835 BC8020 BC8130		KBN30M
K	TB7015 TB730	IB90	BX930 BX850 BX950	BN500 BN7500 BN7000	CB50 CB7525	KB1630 KB1345	MB4020 MB710	KBN475 KBN60M KBN65B	CBN200
		IB05S IB10S	BX470 BX480	BN700 BNC500	CB7050	KB5630 KB9640	MB730	KBN65M KBN70M KBN570	CH3515
	KB90A TB7020		BX90S BXC90	BNS800	CB7925		MBS140	KBN900	CBN200 CBN300 CBN300P CBN350 CBN400C

Grade Comparison Table

► PCD grades

ISO class	TaeguTec	Iscar	Tungaloy	Sumitomo	Sandvik	Kennametal	Mitsubishi	Kyocera	Seco	NTK
N01-N10	TD810	ID8	DX180 DX160	DA90		KD1405	MD203	KPD230	PCD30M PCD30	
N05-N20	KP300	ID5	DX140	DA150	CD10	KD1400	MD220	KPD010	PCD20	PD1
N15-N30	TD830		DX120 DX110	DA2200 DA1000		KD1425	MD205	KPD001	PCD10 PCD05	PD2

► Turning SFEED-RUSH grades

SFEED-RUSH grades have upgraded toughness and chipping resistance through special post-coating treatment process of CVD grades. Through the post-coating treatment process, single color inserts have been transformed into two different colors, on the side and the top (see the illustrations below).

ISO class	Grade	ISO Range	Insert color
P	TT8105B	P05-P15	<p style="text-align: center;">Upgraded SFEED-RUSH Grade</p> <p style="text-align: center;">Special post-coating treatment</p> <p style="text-align: center;">All yellow color Two colors: yellow and black</p>
	TT8115B	P05-P20	
	TT8125B	P15-P30	
	TT8135B	P25-P40	

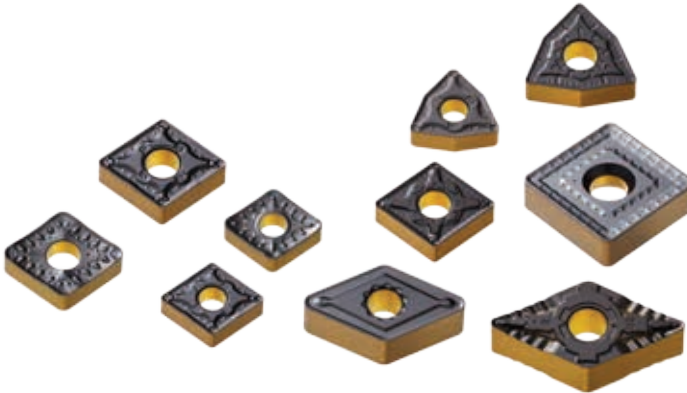

Turning Chip Breaker Comparison Table

▶ Negative insert

ISO classification		Cutting mode	TaeguTec	Sandvik	Kennametal	Seco	
P	Double sided	Finishing with wiper	WS, WA	WF	FW	W-MF2	
		Medium with wiper	WT	WMX, WM	MW, RW	W-M3, W-M6, W-MF5	
		Finishing	FLP, FA, FS, GG-FU FX			FF, FS	FF1, FF2
			FLP, FG FM	QF		FP MP-K, LF, FN	MF2
		Semi-finishing	MLP, FC, FT	PF, XF			
		Medium	VF, DNUX	K			UX
			MLP, PC			MN	MR3
			MGP, PC MM	PM, XM QM		P	MF3 MF5, M3
			MGP, MT	HM, XMR		MP RP, RM	
	Roughing	RGP, RT			MG-, UN	M4 MR4	
	Low carbon steel	FLP, FS, GG-FU MLP, FC	PR			M5 MR7, M6	
	Single sided	Heavy		PR			
RX				RM			
RH			QR MR	MR, RP	R6, RR9 R4, R5, 37 RR6		
HT, HD HY, HZ			HR, 31	RH	R8, 56, 57 R7		
M	Double sided	Finishing	EA, SF	MF	FP	MF1	
		Medium	EM, ML	MM	MP, UP, MR	MF4	
		Roughing	ET	MR MM-MR	RP	MR6, MF5 MM-RR6	
K	Double sided	Finishing-medium	MT	KF KM	FN	MF5 M4	
		Medium	MG-		MG-, RN	M5	
		Roughing	KT RT	KR	UN	MR7	
N	Double sided	Medium	ML	QM, 23	MS, MP		
S	Double sided	Finishing	EA, SF	SF	GG-FS	MF1	
		Medium	GG-ML MGS, MP, MK	SGF, GP- QM, SM, 23	MS, GP-K UP, P	M1 MF4, MF5	
		Roughing	ET	SR, SMR	RP	M5, MR3, MR4	

Walter	Mitsubishi	Sumitomo	Kyocera	Tungaloy	Korloy	Iscar
NF	SW	LUW, SEW	WP	FW, AFW	VW	WF
NM	MW	GUW	WQ, WE	SW, ASW	LW	WG
FP5	FH, FP	FA	DP, GP, PP	TF, 01, CB	HU, VL	SF
FV5	FS, FY	FL	VF	ZF		
NF3, NF4	LP SH	SU, FE	HQ	NS, 11 TS, AS, TSF, TQ	VG, VF VQ	NF, F3P
NS6	SA	LU SE, SX	CQ, PQ CJ	SS, NM ZM	VB, VC, HC, LP	
MV5	ES	GX, HM		S		
MP3			GS			
MP5	MP, MV	GU	PG		VM	M3P
MM5 (NM4)	MA	UG	PS	TM, AM	HS, GS	TF
MU5, NM6 NM9	MH	UX, GE	HS CS		HM, GM	GN
MG-	MG-	UZ	MG- C	33, 37, 38 DM, MG-	B25	MG-
NR4, RP5 RP7	RP GH	ME MU, MX	PT, GT PH, HT	TH	HR, GR	NR, R3P
	FS, FY SY	FL	XF, XP, XP-T XQ, XS	17	VL	
NRF			PX			
NR6	HZ	MP HG HP	HX	THS TRS 57	GH	R3P NM
NRR	HCS HX, HBS, HL	HF HU		65 TU	VT	
	HV, HDS, HXD, HM	HW			VH	T3P
FM5, NF4	FS, LM	SU	MQ, GU	SF	HA, VP2	SF, F3M
MM5 (NM4)	MS, GM, MA	EX, UP, GU	MS, MU, SK	SS, S	HS, GS, MM	TF, VL, M3M
RM5, NR4 NRS	RM	MU, HM	HU	SM	HR, VM, RM	MR, R3M
NM, MK5	LK MA, MK	UZ	KQ MG-	CF CM	VM	GN
NM5, RK5	MG-, GK		KG, C	MG-		MG-
MV7, RK7	GH, RK	GZ	KH ZS, GC	CH	VK, VR, MK GR, RK	
MN3	MJ	UP, GX, AG	A3, AH	P	HA	PP
NF4	FJ, LS	EF	MQ	HRF	VP1	SF
GG-NFT	MJ	SU, UP	TK		VP2	PP
NMS, NMT	MS	EG, EX	MS, MU, SQ	HRM, HMM, SA	VP3	TF, VL
RM5, NRS, NRT	GJ, RS	MU			VM, VP4	MR

Turning Chip Breaker Comparison Table

► Positive insert

ISO classification	Cutting mode	TaeguTec	Sandvik	Kennametal	Seco
P	Medium with wiper	WT	WM	MW	W-F2, W-M3
	Finishing	FA FX	PF, UF	UF, 11, GM	FF1
		GT-SL GT-SA, GT-SM			
		FG	UM XF	FP LF	F1
	Medium	PC, GT-SH FM	PM	MP	
		GT-SH MT	XM PR, UR XR	MF	F2, MF2, M5
		PMR-	PMR-	PMR-	
N	Finishing - Medium - G Tol.	GT-SA, FL	AL	HP	AL
S	Finishing - G Tol.	GT-FGS, SA	GT-UM	GT-HP, LF	GT-F1
	Finishing	FG	MF, UM	FP, LF	F1, F2
	Medium	PC	MM		MF2

Walter	Mitsubishi	Sumitomo	Kyocera	Tungaloy	Korloy	Iscar
PM	MW					WG
PF4, FP4	FV	LU FP	XP GK, GP, DP VF	01, PF, PSF	VL, HFP	38, PF
FV4	SMG	FC	CF GF CK	JS	FS VP1	
PS5	SQ, SV	FK SU SC, SK	XQ GK		VF HMP, C05	SM 16, GT-
FP6, MV4		GU	GQ HQ	PSS PS	MS	
PM5 E47, MT-	MQ, MV MT- G	SF, MU	MT-	PM	C25	14, 17 19, MT-
PMR-	PMR-	UJ	G, PMR-	23		
GW-FS-1	AZ	AW, AG	AH	AL	AK, AR	AF, AS
GT-PF2, FM4	GT-FJ	GT-SI			GT-VP1	
PF4, PS5, MM4	FM, LM, SV	SU	MQ	PSF	VL	PF
PM5, RM4	MM, MV	MU		PSS, PS, PM	MP	

Hardness Conversion Table

Vickers 50kg HV	Brinell HB10mm ball LOAD 3000kgf		Rockwell				Shore's HS	Tensile strength N/mm ² (kgf/mm ²)
	Standard ball	Tungsten carbide ball	A scale 60kgf diamond brale HRA	B scale 100kgf 1/16in ball HRB	C scale 150kgf diamond brale HRC	D scale 100kgf diamond brale HRD		
1900			93.1		80.5			
1800			92.6		79.2			
1700			91.9		77.9			
1600			91.3		76.6			
1500			90.5		75.3			
1450			90.1		74.6			
1400			89.6		74.0			
1350			89.1		73.4			
1300			88.7		72.7			
1250			88.3		72.1			
1200			87.9		71.5			
1150			87.5		70.9			
1100			87.1		70.3			
1050			86.6		69.6			
1000			86.2		68.9			
940			85.6		68.0	76.9	97	
920			85.3		67.5	76.5	96	
900			85.0		67.0	76.1	95	
880		(767)	84.7		66.4	75.7	93	
860		(757)	84.4		65.9	75.3	92	
840		(745)	84.1		65.3	74.8	91	
820		(733)	83.8		64.7	74.3	90	
800		(722)	83.4		64.0	74.8	88	
780		(710)	83.0		63.3	73.3	87	
760		(698)	82.6		62.5	72.6	86	
740		(684)	82.2		61.8	72.1	84	
720		(670)	81.8		61.0	71.5	83	
700		(656)	81.3		60.1	70.8	81	
690		(647)	81.1		59.7	70.5		
680		(638)	80.8		59.2	70.1	80	
670		630	80.6		58.8	69.8		
660		620	80.3		58.3	69.4	79	
650		611	80.0		57.8	69.0		
640		601	79.8		57.3	68.7	77	2205(210)
630		591	79.5		56.8	68.3		2020(206)
620		582	79.2		56.3	67.9	75	1985(202)
610		573	78.9		55.7	67.5		1950(199)
600		564	78.6		55.2	67.0	74	1905(194)
590		554	78.4		54.7	66.7		1860(190)
580		515	78.0		54.1	66.2	72	1825(186)
570		535	77.8		53.6	65.8		1795(183)
560		525	77.4		53.0	65.4	71	1750(179)
550	(505)	517	77.0		52.3	64.8		1750(174)
540	(496)	507	76.7		51.7	64.4	69	1660(169)
530	(488)	497	76.4		51.1	66.2		1620(165)
520	(480)	488	76.1		50.5	63.5	67	1570(160)
510	(473)	479	75.7		49.8	62.9		1530(156)
500	(465)	471	75.3		49.1	62.2	66	1459(153)
490	(456)	460	74.9		48.4	61.6		1460(149)
480	488	452	74.5		47.7	61.3	64	1410(144)





• Note: Gray figures come from ASTM E 140 table (Calculated by SAE-ASM-ASTM together)







Vickers 50kg HV	Brinell HB10mm ball LOAD 3000kgf		Rockwell				Shore's HS	Tensile strength N/mm ² (kgf/mm ²)
	Standard ball	Tungsten carbide ball	A scale 60kgf diamond brale HRA	B scale 100kgf 1/16in ball HRB	C scale 150kgf diamond brale HRC	D scale 100kgf diamond brale HRD		
470	441	442	74.1		46.9	60.7		1570(160)
460	433	433	73.6		46.1	60.1	62	1530(156)
450	425	425	73.3		45.3	59.4		1459(153)
440	415	415	72.8		44.5	58.8	59	1460(149)
430	405	405	72.3		43.6	58.2		1410(144)
420	397	397	71.8		42.7	57.5	57	1370(140)
410	388	388	71.4		41.8	56.8		1330(136)
400	379	379	70.8		40.8	56.0	55	1290(131)
390	369	369	70.3		39.8	55.2		1240(127)
380	360	360	69.8	(110.0)	38.8	54.4	52	1250(123)
370	350	350	69.2		37.7	53.6		1170(120)
360	341	341	68.7	(109.0)	36.6	52.8	50	1130(115)
350	331	331	68.1		35.5	51.9		1095(112)
340	322	322	67.6	(108.0)	34.4	51.1	47	1070(109)
330	313	313	67.0		33.3	50.2		1035(105)
320	303	303	66.4	(107.0)	32.2	49.4	45	1005(103)
310	294	294	65.8		31.0	48.4		980(100)
300	284	284	65.2	(105.5)	29.8	47.5	42	950(97)
295	280	280	64.8		29.2	47.1		935(96)
290	275	275	64.5	(104.5)	28.5	46.5	41	915(94)
285	270	270	64.2		27.8	46.0		905(92)
280	265	265	63.8	(103.5)	27.1	45.3	40	890(91)
275	261	261	63.5		26.4	44.9		875(89)
270	256	256	63.1	(102.0)	25.6	44.3	38	855(87)
265	252	252	62.7		24.8	43.7		840(86)
260	247	247	62.4	(101.0)	24.0	43.1	37	825(84)
255	243	243	62.0		23.1	42.2		805(82)
250	238	238	61.6	99.5	22.2	41.7	36	795(81)
245	233	233	61.2		21.3	41.1		780(79)
240	228	228	60.7	98.1	20.3	40.3	34	765(78)
230	219	219		96.7	(18.0)		33	730(75)
220	209	209		95.0	(15.7)		32	695(71)
210	200	200		93.4	(13.4)		30	670(68)
200	190	190		91.5	(11.0)		29	635(65)
190	181	181		89.5	(8.5)		28	605(62)
180	171	171		87.1	(6.0)		26	580(59)
170	162	162		85.0	(3.0)		25	545(56)
160	152	152		81.7	(0.0)		24	515(53)
150	143	143		78.7			22	490(50)
140	133	133		75.0			21	455(45)
130	124	124		71.2			20	425(44)
127	121			69.8			19	(42)
122	116			67.6			18	(41)
117	111			65.7			15	(39)

• Note: Gray figures come from ASTM E 140 table (Calculated by SAE-ASM-ASTM together)

Material Conversion Table





► According to VDI 3323 standard







Material group					
	AISI/SAE	Material No. DIN	BS	EN	AFNOR
1	A 366 (1012) 1008	0.0030 C10	040 A 10 045 M 10 1449 10 CS		AF 34 C 10 XC 10
1		1.0028 Ust 34-2 (S250G1T)			A 34-2
1		1.0034 RSt 34-2 (S250G2T)	1449 34/20 HR, HS, CR, CS		A 34-2 NE
1		1.0035 St185 (Fe 310-0) St 33	Fe 310-0 1449 15 HR, HS		A 33
1	A 570 Gr. 33,36	1.0036 S235JRG1 (Fe 360 B) Ust 37-2	Fe 360 B 4360-40 B		
1		1.0037 S235JR (Fe 360 B) St 37-2	Fe 360 B 4360-40 B		E 24-2
1	1115	1.0038 GS-CK16	030A04	1A	
1	A 570 Gr. 40	1.0044 S275JR (Fe 430 B) St44-2	Fe 430 B FN 1449 43/25 HR, HS 4360-43 B		E 28-2
1		1.0045 S355JR	4360-50 B		E 36-2
1	A 570 Gr.50 A 572 Gr.50	1.0050 E295 (Fe 490-2) St 50-2	Fe 490-2 FN 4360-50 B		A 50-2
1	A 572 Gr. 65	1.0060 E335 (Fe 590-2) St 60-2	Fe 60-2 4360-55 E; 55 C		A 60-2
1		1.0060 St 60-2			
1		1.0070 E360 (Fe 690-2) St 70-2	Fe 690-2 FN		A 70-2
1		1.0112 P235S	1501-164-360B LT20		A37AP
1		1.0114 S235JU;St 37-3 U	4360-40C		E 24-3
1	A 284 Gr.D A 573 Gr.58 A 570 Gr 36;C A 611 Gr. C	1.0116 S235J2G3 (Fe 360 D 1) St 37-3	Fe 360 D1 FF 1449 37/23 CR 4360-40 D		E 24-3 E 24-4
1		1.0130 P265S	1501-164-400B LT 20		A 42 AP
1		1.0143 S275J0; St 44-3 U	4360-43C		E 28-3

					
SS	UNI	UNE	JIS	KS	GOST
	C 10 1 C 10	F.1511 F.151A	S 10C	SM 10C	10
	Fe 330, Fe 330 B FU		SS 330	SS 330	
	Fe 330 B FU				St2sp
1300	Fe 320	Fe 310-0			St0
1311	FE37BFU	AE 235 B			16D, 18Kp
1312		Fe 360 B			St3Kp
1311	Fe 360 B 1449 37/23 HR	AE 235 B Fe 360 B	STKM 12A;C	STKM 12A;C	
1325	Fe 330, Fe 330 B FU		SS 330	SS 330	
1412	Fe 430 B Fe 430 B FN	AE 275 B Fe 430 B FN	SM 400 A;B;C	SM 400 A;B;C	St4ps; sp
2172	Fe 510 B	AE 355 B			
1550	Fe 490	a 490-2	SS 490	SS 490	ST5ps; sp
2172		Fe 490-2 FN			
1650	Fe 60-2 Fe 590	A 590-2 Fe 590-2 FN	SM 570	SM 570	St6ps; sp
	Fe 60-2				
1655	Fe 70-2 Fe 690	A 690-2 Fe 690-2 FN			
	Fe 360 C	AE 235 C			
	Fe 360 C	AE 235 C			
1312	Fe 360 D1 FF				
1313	Fe 360 C FN Fe 360 D FF Fe 37-2	AE 235 D Fe 360 D1 FF			St3kp; ps; sp 16D
		SPH 265			
1414-01	Fe 430 D	AE 275 D			

Material Conversion Table





► According to VDI 3323 standard







Material group					
	AISI/SAE	Material No. DIN	BS	EN	AFNOR
1	A 573 Gr. 70 A 611 Gr.D	1.0144 S275J2G3 (Fe 430 D 1) St 44-3	Fe 430 D1 FF 4360-43 C; 43 D		E 28-3 E 28-4
1		1.0149 S275JOH; RoSt 44-2	4360-43C		
1		1.0226 DX51D; St 02 Z	Z2		GC
1	M 1010	1.0301 C10	040 A 10 045 M 10 1449 10 CS		AF 34 C 10 XC 10
1	A 621 (1008)	1.0330 DC 01 St 2; St 12	1449 4 CR 1449 3 CS		TE
1	A 619 (1008)	1.0333 Ust 3 (DC03G1) Ust 13	1449 2 CR;3 CR		E
1	A 621 (1008)	1.0334 UStW 23 (DD12G1)			SC
1	A 622 (1008)	1.0335 DD13; StW 24	1449 1 HR		3C
1	A 620 (1008)	1.0338 DC04 St4; St 14	1449 1 CR;2 CR		ES
1	A 516 Gr. 65; 55 A 515 Gr. 65;55 A 414 Gr. C A 442 Gr.55	1.0345 P235GH HI	1501 Gr. 141-360 1501 Gr. 161-360; 151-360 1501 Gr. 161-400; 154-360 1501 Gr. 164-360; 161-360		A 37 CP;AP
1	(M) 1020 M 1023	1.0402 C22	055 M 15, 070 M 20 2C/2D 1499 22 HS, CS		AF 42 C 20; XC 25;1 C 22
1	1020	1.0402 C22	050A20 2C/2D		CC20
1	1020;1023	1.0402 C22	055 M 15, 070 M 20 2C		AF 42 C 20; XC 25;1 C 22
1		1.0425 P265GH H II	1501 Gr. 161-400;151-400 1501 Gr. 164-360; 161-400 1501 Gr. 164-400;154-400		A 42 CP; AP
1	A27 65-35	1.0443 GS-45	A1		E 23-45 M
1		1.0539 S355NH;StE 335			TSE 355-4
1		1.0545 S355N; StE 355	4360-50E		E 355 R
1		1.0546 S355NL;TStE 355	4360-50EE		E 355 FP
1		1.0547 S355JOH	4360-50C		TSE 355-3
1		1.0549 S355 NLH;TStE 355			
1		1.0553 S355JO;St 52-3U	4360-50C		E 36-3

					
SS	UNI	UNE	JIS	KS	GOST
1411, 1412 1414	Fe 430 B, Fe 430 C (FN) Fe 430 D (FF)	AE 275 D Fe 430 D1 FF	SM 400 A;B;C	SM 400 A;B;C	St4kp> ps; sp
1412-04	Fe 430 C	Fe 430 C			
1151 10	FeP 02 G C 10 1 C 10	FeP 02 G F.1511 F.151.A	S 10C	SM 10C	10
1142	FeP 00 FeP 01 FeP 02	AP 11 AP 02	SPHD SPCD	SPHD SPCD	15kp
	FeP 12 FeP 13	AP 12 AP 13	SPHE SPHE	SPHE SPHE	10kp 08kp
1147	FeP 04	AP 04	SPCE	SPCE	08jU; JUA
1331 1330	FeE235, Fe 360 1 KW;KG Fe 360 2 KW;KG	A 37 RC I RA II	SGV 410, SGV 450, SGV 48, SPV 450;SPV 480	SGV 410, SGV 450, SGV 480, SPPV 450;SPPV 480	
1450	C 20 C 21, C 25	1 C 22 F.112	S20C	SM 20C	20
1450	C20, C21	F.112	S22C	SM 22C	20
1450	C 20; C 21;C 25	1 C 22F.112	S 20 C;S 22 C	SM 20 C;SM 22C	
1431 1430 1432 1305	Fe 410 1 KW; KG; KT Fe 410 2 KW; KG	A 42 RC I A 42 RC II	SPV 315; SPV 355 SG 295; SGV 410 SGV 450; SGV 480	SPPV 315; SPPV 355 SG 295; SGV 410 SGV 450; SGV 480	16K 20K
2134-04	Fe 510 B	Fe 355 KGN			
2334-01	FeE 355 KG	AE 355 KG			
2135-01	FeE 355 KT	AE 355 KT			
2172-04	Fe 510 C	Fe 510 C			
2135	Fe 510 D Fe 510 C	FeE 355 KTM			

Material Conversion Table





► According to VDI 3323 standard







Material group	 AISI/SAE	 Material No. DIN	 BS	 EN	AFNOR
1	A 633 Gr.C A 588	1.0562 P355N StE 355	1501 Gr.225-490A LT 20		FeE 355 KG N E 355 R/FP; A 510 AP
1		1.0565 P355NH; WStE 355	1501-225-490B LT 20		A 510 AP
1		1.0566 P355NL1; TStE 355	1501-225-490A LT 50		A 510 FP
1	1	1.0570 S355J2G3 St 52-3	Fe 510 D1 FF 1449 50/35 HR>HS 4360-50 D		E 36-3 E 36-4
1	1213	1.0715 9 SMn 28 (1SMn30)	230 M 07		S 250
1	1213	1.0715 9 SMn 28	230 M 07		S 250
1	12 L 13	1.0718 9 SMnPb 28 (11SMnPb30)			S 250 Pb
1	1108 1109	1.0721 10 S 20	(210 M 15)		10S20 10F 2
1	11 L 08	1.0722 10 SPb 20			10PbF 2
1	11 L 08	1.0722 10 SPb 20			10PbF 2
1	1215	1.0736 9 SMn 36 11SMn37)			S 300
1	12 L 14	1.0737 9 SMnPb 36 (11SMnPb37)			
1		1.0972 S315MC; QStE 300 TM	1501-40F30		E 315 D
1		1.0976 S355MC; QStE 360 TM	1501-43F35		E 355 D
1		1.0982 S460MC; QStE 460 TM	1501-50F45		
1		1.0984 S500MC; QStE 500 TM			E 490 D
1		1.0986 S500MC; QStE 500 TM	1501 - 60F55		E 560 D
1	1010	1.1121 CK 10 (C10E)	040 A 10		XC 10
1		1.1121 St 37-1	4360 40 A		
1	1015	1.1141 CK 15 (C15E)	040 A 15 080 M 15	32C	XC 12 XC 15 XC 18
1	1020 1023	1.1151 C22E CK 22	055 M 15 (070 M 20)		2 C 22 XC 18 XC 25
1	D 3	1.2080 X 210 Cr 12	BD 3		Z 200 C 12

					
SS	UNI	UNE	JIS	KS	GOST
2106	FeE 355 KG;KW	AEE 355 KG;DD	SM 490 A;B;C; YA;YB	SM 490 A;B;C; YA;YB	15GF
2106	FeE 355-2				
2107-01	FeE 355-3				
2132, 2133	17GS	AE 355 D	SM 490 A;B;C;	SM 490 A;B;C;	17GS
2134,	17G1S	Fe 510, D1 FF	YA;YB	YA;YB	17G1S
2174					
1912	CF SMn 28	F.2111 - 11 SMn 28	SUM 22	SUM 22	
1912	CF 9 SMn 28	11 SMn 28	SUM 22	SUM 22	
1914	CF 9 SMnPb 28	F.2112-11 SMnPb 28	SUM 22 L SUM 23 L, SUM 24 L	SUM 22 L SUM 23 L, SUM 24 L	
	CF 10 S 20	F. 2121 - 10 S 20			
	CF 10 SPb 20	F.2122-10 SPb 20			
	CF 10 SPb 20	10 SPb 20			
	CF 9 Mn 36	F.2113 - 12 SMn 35	SUM25	SUM25	
2642	FeE 355TM				
2662	FeE 490 TM FeE 560 TM				
1265	C 10, 2 C 10 2 C 15	F-1510-C 10 K	S 9 CK S 10 C	S 9 CK S 10 C	08;10
1300					
1370	C 15	C 16 F.1110-C 15 F.1511-C 16 K	S 15 S 15 CK	SM 15C SM 15CK	15
1450	C 20	C 25 F.1120-C 25 K	S 20 C, S 20 CK S 22 C	SM 20 C, SM20 CK SM22 C	20
2642					

Material Conversion Table





► According to VDI 3323 standard







Material group					
	AISI/SAE	Material No. DIN	BS	EN	AFNOR
1	A36	St 44-2	4360 43 A		NFA 35-501 E 28
1		StE 320-3Z	1 501 160		
1	A572-60	1.8900 StE 380	4360 55 E		
2	(M) 1025	1.0406 C 25	070 M 26		1 C 25
2		1.0416 GS-38			20-400 M
2	A 537 Cl.1 A 414 Gr. G A 612	1.0473 P355GH	19 Mn 6		A 52 CP
2	1035	1.0501 C 35	080 A 32, 080 A 35 080 M 36, 1449 40 CS		1 C 35 AF 55 C 35 XC 38
2	1045	1.0503 CF 45 (C45G)	060 A 47 080 M 46		XC 42 H 1 TS
2	1040	1.0511 C 40	080 M 40		1 C 40 AF 60 C 40
2		1.0540 C 50			
2	A27 70-36	1.0551 GS-52	A2		280-480 M
2	A148 80-40	1.0553 GS-60	A3		320-560 M
2	A738	1.0577 S355J2G4 (Fe 510 D 2)	Fe 510 D2 FF 1501 Gr.224-460 1501 Gr. 224-490		A 52 FP
2	1140	1.0726 35 S 20	212 M 36	8M	35MF 6
2	1146	1.0727 45 S 20 (46S20)			45 MF 4
2	1035 1041	1.1157 40Mn4	150 M 36	15	35 M 5 40 M 5
2	1025	1.1158 C25E CK 25	(070 M 25)		2 C 25 XC 25
2	1536	1.1166 34Mn5			
2	1330	1.1170 28Mn6	(150 M 28), (150 M 18)		20 M 5, 28 Mn 6
2	1330	1.1170 28Mn6	150 M 5		20 M 5
2	1330	1.1170 28Mn6		14A	20 M 5
2		1.1178 C30E; CK 30	080M30		XC 32

 SS	 UNI	 UNE	 JIS	 KS	 GOST
1411					
1421					
2145	FeE390KG		S 25C	SM 25C	
	C 25 1 C 25				
1306					
2101	Fe E 355-2	A 52 RC I RA II	SGV 410	SGV 410	
2102			SGV 450	SGV 450	
			SGV 480	SGV 480	
1572	C 35	F.113	S35C	SM35C	35
1550	1 C 35				
1672	C 43		S 45 C	SM 45 C	45
	C 46				
	C 40	1 C 40	S 40 C	SM 40 C	
1674	C 50	1 C 50			
1505					
1606					
2107		A 52 RB II AE 355 D			
1957		F.210.G			
1973			S 09CK	SMn 433	
C 25	F.1120 - C 25 K	S 25 C S 28 C	S 25 C	SM 25 C	
	TO.B	SMn 433 H			
1421	C 28 Mn	28 Mn 6	SCMn 1	SCMn 1	30G
2145					
	C 28 Mn		SCMn 1	SCMn 1	
	C 30	2 C 30			

Material Conversion Table





► According to VDI 3323 standard







Material group					
	AISI/SAE	Material No. DIN	BS	EN	AFNOR
2	1035	1.1180 C35R Cm 35	080 A 35		3 C 35 XC 32
2	1035 1038	1.1181 C35E CK 35	080 A 35 (080 M 36)		2 C 35, XC 32 XC 38 H 1
2	1035	1.1181 C35E CK 35	080 A 35 (080 M 36)		
2	1042	1.1191 GS- Ck 45	080 A 46		XC 45
2	1049 1050	1.1206 C50E CK 50	080 M 50		2 C 50 XC 48 H 1; XC 50 H 1
2	1050 1055	1.1213 Cf 53 (C53G)	070 M 55		XC 48 H TS
2	4520	1.5423 22Mo4	1503-245-420		
3		1.0050 St50-2			
3	A 516 Gr.70 A 515 Gr. 70 A 414 Gr.F; G	1.0481 P295GH 17 Mn 4	1501 Gr. 224		a 48 Cp;AP
3	1043	1.0503 C35	060 A 47 080 M 46 1449 50 HS, CS		1 C 45 AF 65 C 45
3	1074	1.0614 C 76 D; D 75-2			XC 75
3	1086	1.0616 C 86 D; D 85-2			XC 80
3	1095	1.0618 C 92 D;D 95-2			XC 90
3	1036 1330	1.1165 30Mn5	120 M 36 (150 M 28)		35 M 5
3	1335	1.1167 30Mn5	150 M 36		40 M 5
3	1040	1.1186 C40E CK 40	060 A 40, 080 A 40 080 M 40		2 C 40 XC 42 H 1
3	1045	1.1191 C45E CK 45	080 M 46 060 A 47		2 C 45 XC 42 H 1 XC 45 XC 48 H 1

 SS	 UNI	 UNE	 JIS	 KS	 GOST
1572		F.1130-C 35 K-1			
1550	C35	F.1130-C 35 K	S 35 C	SM 35 C	35
1572					
1572	C36		S 35 C	SM 35 C	
1660	C45	F-1140			
1674	C 50				50
1674	C 53		S 50 C	SM 50 C	50
	16 Mo 5 KG; KW	F.2602- 16 Mo 5	SB 450 M	SB 450 M	SB 480 M
	FE50				
	Fe 510 KG;KT;KW Fe 510-2 KG;KT;KW FeE 295	A 47 RC I RA II	SG 365, SGV 410 SGV 450 SGV 480	SG 365, SGV 410 SGV 450 SGV 480	14G2
1672	C 45	F.114	S 45 C	SM 45 C	45
1650	1 C 45				
C 85					
		F.8211-30 Mn 5 f.8311-AM 30 Mn 5	SMn 433 H SCMn 2	SMn 433 H SCMn 2	27ChGSNMDTL 30GSL
2120		F. 1203-36 Mn 6 F. 8212-36 Mn 5	SMn 438 (H) SCMn 3	SMn 438 (H) SCMn 3	35G2 35GL
	C 40		S 40 C	SM 40 C	
1672	C 45 C 46	F.1140-C 45 K F.1142-C48 K	S 45 C S 48 C	S 45 C S 48 C	45

Material Conversion Table





► According to VDI 3323 standard







Material group					
	AISI/SAE	Material No. DIN	BS	EN	AFNOR
3	1049	1.1201 C45R Cm 45	080 M 46		3 C 45 XC 42 H 1 XC 48 H 1
3		1.7242 18 CrMo 4			
3	A 387 Gr. 12 Cl	1.7337 16 CrMo 4 4			
3	A 387 Gr. 12 Cl	1.7337 16 CrMo 4 4			
3		1.7362 12 CrMo 19 5	3606-625		Z 10 CD 5.05
3	A572-60	17 MnV 6	436055 E		NFA 35-501 E 36
4	1055	1.0535 C55	070 M 55		1 C 55 AF 70 C 55
4	1060	1.0601 C60	060 A 62 1449 HS,CS	43D	1 C 60 AF 70 C 55
4	1070	1.0603 C67	080 A 67 1449 70HS		XC65
4	1074 1075	1.0605 C75	1449 80 HS		
4	1055	1.1203 C55E CK 55	060 A 57 070 M 55		2 C 5 XC 55 H 1
4	1055	1.1209 C55R Cm 55	070 M 55		3 C 55 XC 55 H 1
4	1060 1064	1.1221 C60E CK 60	060 A 62	43D	2 C 60 XC 60 H 1
4	1070	1.1231 CK 67 (C67E)	060 A 67		XC 68
4	1074 1075 1078	1.1248 CK 75 (C75E)	060 A 78		XC 75
4	1086	1.1269 CK 85 (C85E)			XC 90
4	1095	1.1274 Ck 101 (C101E)			XC 100
4	W 112	1.1663 C 125 W			Y2 120
4					
5		1.0070 St70-2			
5		1.7238 49 CrMo 4			
5		1.7701 51 CrMoV 4			

					
SS	UNI	UNE	JIS	KS	GOST
1660	C 45	F.1145-C 45K-1 F.1147C 48 K-1	S 50 C	SM 50 C	
18 CrMo 4	A 18 CrMo 4 5 KW A 18 CrMo 4 5 KW 16 CrMo 20 5				
2142					
1655	C 55 1 C 55		S 55 C	SM 55 C	55
	C 60 1 C 60		S 58 C	SM 58 C	60(G)
	C 67				
	C 75				75
1655	C 55	F.1150-C 55 K	S 55 C	SM 55 C	55
	C 55	F.1155-C 55 K-1			
1655	C 60		S 58 C	SM 58 C	60
1678					60G, 60GA
1770	C 70				65GA 68GA, 70
774	C 75				75(A)
	C 90				85(A)
	C 100	F-5117	SUP 4	SPS 4	
1870					
2223	FE70-2				
	51 CrMoV 4				

Material Conversion Table



► According to VDI 3323 standard







Material group					
	AISI/SAE	Material No. DIN	BS	EN	AFNOR
6	A573-81 65	1.0116 St 37-3	4360 40 B		E 24-U
6	A515 65	1.0345 H1	1 501 161		A 37 CP
6	5120	1.0841 St 52-3	150 M 19		20 MC 5
6	9255	1.0904 55 Si 7	250A53	45	55S7
6	9254	1.0904 55 Si 7	250 A 53		55 S 7
6	9262	1.0961 60SiCr7	1 501 161		60SC6
6	L3	1.2067 100Cr6	BL3		Y100C6
6	L1	1.2108 90 CrSi 5			
6	L2	1.2210 115CrV3			100C3
6		1.2241 51CrV4			
6		1.2311 40 CrMnMo 7			
6	4135	1.2330 35 CrMo 4	708 A 37		34 CD 4
6		1.2419 105WCr6	BO1		105WC13
6	0 1	1.2510 100 MnCrW 4	BS1		8 MO 8
6	S1	1.2542 45 WCrV7			
6	S1	1.255 60WCrV7			55WC20
6	L6	1.2713 55NiCrMoV6			55NCDV7
6	L6	1.2721 50NiCr13			55 NCV 6
6	O2	1.2842 90MnCrV8	BO2		90 MV8
6	E 50100	1.3501 100 Cr 2			55WC20
6	52100	1.3505 100Cr6	2 S 135 535 A 99	31	100 C 6
6		1.5024 46Si7			45 S 7; Y 46 7;46 SI 7
6	9255	1.5025 51Si7			51 S 7 51 Si 7
6	9255	1.5026 55Si7	251 a 58		55 S 7
6	9260	1.5027 60Si7	251 A 60 251 H 60		60 S 7
6	9260 H	1.5028 65Si7			60 S 7
6		1.5120 38 MnSi 4			

					
SS	UNI	UNE	JIS	KS	GOST
1312	Fe37-3				
1330					
2172	Fe 52	F-431			
2085	55Si8	56Si7			
2090		F-431			
60SiCr8	60SiCr8				
	100Cr6				
2092	105WCR 5				
	107CrV3KU				
	35 cRmO 8 KU				
2234	35CrMo4	34CrMo4	SCM435TK	SCM435TK	
2140	10WCr6	105WCr5			
2140	10WCr6	105WCr5	SKS 31	STS 31	
2710	45 WCrV8 KU	45WCrSi8			
2710	58WCr9KU				
		F.520.S	SKT 4	STF 4	
2550		f-528			
2258	100Cr6	F.1310 - 100 Cr 6	SUJ2	STB 2	SchCh 15
		F. 1451 - 46 Si 7			
2090	48 Si 7	F.1450-50 Si 7			
	50 Si 7				
2085 2090	55 Si 7	F.1440 - 56 Si 7			55S2
	60 Si 7	F. 1441 - 60 Si 7			60S2
			50 P 7 SUP 6	SPS 6	

Material Conversion Table

► According to VDI 3323 standard







Material group					
	AISI/SAE	Material No. DIN	BS	EN	AFNOR
6	A 204 Gr.A 4017	1.5415 16Mo3 15 Mo 3	1503-243 B		15 D 3
6	4419	1.5419 20Mo4	1503-243-430		
6	A 350-LF 5	1.5622 14Ni6			16N6
6	3415	1.5732 1 NiCr10			14 NC 11
6	3310; 3314	1.5752 14NiCr14	655M13	36A	12NC15
6		1.6587 17CrNiMo6	820A16		18NCD6
6		1.6657 14NiCrMo134			
6	5515	1.7015 15 Cr 3	523 M 15		12 C 3
6	5132	1.7033 34Cr4	530A32	18B	32C4
6	5140	1.7035 41C r4	530M40	18	42C4
6	5140	1.7045 42Cr41	530 A 40		42 C 4 TS
6	5115	1.7131 16MnCr5	527 M 17		16 MC 5
6		1.7139 16MnCr5			
6	5515	1.7176 55Cr3	527 A 60	48	55 C 3
6	4135; 4137	1.7220 34CrMo4	708 Aa 37		35 CD 4
6	4142	1.7223 41CrMo4			
6	4140	1.7225 42CrMo4	708 M 0		42 CD 4
6		1.7228 55NiCrMoV6G	823M30	33	
6		1.7262 15CrMo5			12 CD 4
6		1.7321 20 mOcR 4			
6	ASTM A182 F-12	1.7335 13CrMo4 4	1501-620Gr27		
6	A 182-F11;12	1.7335 13 CrMo 4 4	1 501 620 Gr. 27		15 CD 4.5
6	ASTM A 182 F.22	1.7380 10CrMo9 10	1501-622gr31; 45		
6	A182 F-22	1.7380 10 CrMo 9 10	1501-622		12 CD 9.10
6		1.7715 14MoV6 3	1503-660-440		
6	A355A	1.8509 41CrAlMo 7	905 M 39	41B	40 CAD 6.12
7	A570.36	1.0038 S235JRG2 (Fe 360 B) RSt 37-2	Fe 360 B FU 1449 27/23 CR 4360-40 B		E 24-2NE
7	3135	1.5710 36NiCr6	640A35		35NC6

					
SS	UNI	UNE	JIS	KS	GOST
2912	16Mo3(KG;KW)	F. 2601 - 16 Mo 3			
-2512	G 20 Mo 5 G 22 Mo5		SCPH 11	SCPH 11	
14 Ni 6 KG;KT	F.2641 - 15 Ni 6				
16NiCr11	15NiCr11	SNC415(H)			
		SNC815(H)			
	14NiCrMo13				
	14NiCrMo131				
			SCr415(H)	SCr415(H)	
	34Cr4(KB)	35Cr4	SCr430(H)	SCr430(H)	
	41Cr4	42Cr4	SCr440(H)	SCr440(H)	
2245	41Cr4	42Cr4	SCr440	SCr440	
2511	16MnCr5	16MnCr5			
2127					
2253			SUP9(A)	SPS 9(A)	
2234					
	41CrMo4	42CrMo4	SNB 22-1	SNB 22-1	
2244					
2512	653M31				
2216		12CrMo4			
2625					
	14CrMo4 5	14CrMo45			
2216		12CrMo4	SCM415(H)	SCM415(H)	
2218	12CrMo9,10	TU.H			
		13MoCrV6			
2940	41CrAlMo7	41CrAlMo7			
1312	Fe 360 B FN	AE 235 B FN;FU Fe 360 B FN; FU			St3ps; sp

Material Conversion Table





► According to VDI 3323 standard







Material group					
	AISI/SAE	Material No. DIN	BS	EN	AFNOR
7		1.5755 31 NiCr 14	653 M 31		18 NC 13
7	8620	1.6523 2 NiCrMo2	805M20	362	20 NCD 2
7	8740	1.6546 40 NiCrMo 22	311-Tyre 7		
7	4130	1.7218 25CrMo4	CDS 110		25 CD 4
7		1.7733 24 CrMoV 5 5			20 CDV 6
7		1.7755 GS-45 CrMOV 10 4			
7		1.8070 21 CrMoV 5 11			
8	4142	1.2332 47 CrMo 4	708 M 40	19A	42 CD 4
8	A128 (A)	1.3401 G-X120 Mn 12			Z 120 M 12
8	3435	1.5736 36 NiCr 10			30 NC 11
8	9840	1.6511 36CrNiMo4	816M40	110	40NCD3
8	4340	1.6582 35CrNiM 6	817 M 40	24	35 NCD 6
8		1.7361 32 CeMo12	722 M 24	40B	30 CD 12
8	6150	1.8159 50 CrV 4	735 A 50	47	50CrV4
8		1.8161 58 CrV 4			
8		1.8515 32 CrMo 12	722 M 24	40B	30 CD 12
8		1.8523 39CrMoV13 9	897M39	40C	
9		1.4882 X 50 CrMnNiNbN 21 9			Z 50 CMNNb 21.09
9	3135	1.5710 36NiCr6	640A35	111A	35NC6
9		1.5864 35 niCr 18			
9		31 NiCrMo 13 4	830 m 31		
10	A573-81	1.0144 ST 44-3	4360 43 C		E 28-3
10	A 619	1.0347 DCO3 RSt;RRSt 13	1449 3 CR 1449 2 CR		E
10	M 1015 M 1016 M 1017	1.0401 C15	080 M 15 080 M 15 1449 17 CS		AF 37 C12 XC 18
10		1.0570 ST 52-3	4360 50 B		E 36-3
10	12L13	1.0718 9SMnPb28			S250Pb
10	(12L13)	1.0718 9 SMnPb 28			S 250 Pb

					
SS	UNI	UNE	JIS	KS	GOST
2506	20NiCrMo2	20NiCrMo2	SNCM220(H)	SNCM220(H)	
	40NiCrMo2(KB)	40NiCrMo2	SNCM240	SNCM240	
2225	25CrMo4(KB)	55Cr3	SCM420/430	SCM420/430	
	21 CrMoV 5 11				
	35 NiCr 9				
2244	42CrMo4	42CrMo4	SCM (440)	SCM (440)	
2183	GX120Mn12	F. 8251-AM-X120Mn12	SCMnH 1, SCMn H 11	SCMnH 1, SCMn H 11	110G13L
	36NiCrMo4(KB)	35NiCrMo4	SUP 10	SPS 10	
2541	35NiCrMo6(KB)		SNCM 447	SNCM 447	
2240	30CrMo12	F.124.A			
2230	50CrV4	51CrV4			
2240	32CrMo12	F.124.A			
	36CrMoV12				
			SNC236	SNC236	
2534		f-1270			
1412			SM 400A;B;C	SM 400A;B;C	
	Fep 02	AP 02			08JU
1350	C15				
	C16	F.111	S 15 C	SM 15 C	
	1 C 15				
2132	Fe52BFN/Fe52CFN		SM490A;B;C;YA;YB	SM490A;B;C;YA;YB	
1914	CF9SMnPb28	11SMnPb28			
1914	CF 9 SMnPb 28	11 SMnPb 28	SUM 22L	SUM 22L	

Material Conversion Table





► According to VDI 3323 standard





Material group					
	AISI/SAE	Material No. DIN	BS	EN	AFNOR
10		1.0723 15 S 22 15 S 20	210 A 15 210 M 15		
10		1.2083			
10	H 11	1.2343 x 38 CrMoV 5 1	BH 11		Z 38 CDV 5
10	H 13	1.2344 X 40 CrMoV 5 1	BH 13		Z 40 CDV 5
10	A 2	1.2363 X100 CrMoV 5 1	BA 2		Z 100 CDV 5
10	D 2	1.2379 X 155 CrVMo 12 1	BD2		Z 160 CDV 12
10	HNV3	1.2379 X210Cr12G	BD2		Z160CDV12
10	D 4 (D 6)	1.2436 X 210 CrW 12	BD6		Z 200 CD 12
10	H 21	1.2581 X 30 WCv 9 3	BH 21		Z 30 WCV 9
10		1.2601 X 165 CrMoV 12			
10	H 12	1.2606 X 37 CrMoW 5 1	BH 12		Z 35 CWDV 5
10	D3	1.3343 S 6-5-2	BM2		Z200C12
10	N08028	1.4563			Z1NCDU31-27-03
10	ASTMA353	1.5662 X8Ni9	1501-509;510		
10	ASM A353	1.5662 X8Ni9	502-650		9 Ni
10	2517	1.5680 12Ni19	12Ni19		Z18N5
10	2515	1.5680 12 Ni 19			Z 18 N 5
11		1.3202 S 12-1-4-5	BT 15		
11		1.3207 S 10-4-3-10	BT 42		Z130WKCDV
11	T15	1.3243 S 6-5-2-5			KCV 06-05-05-04-02
11		1.3246 S 7-4-2-5			Z110 WKCDV 07-05-04
11		1.3247 S 2-10-1-8	BM 42		Z110 DKCWW 09-08-04
11	M 42	1.3249 S 2-9-2-8	BM 34		
11	T 4	1.3255 S 18-1-2-5	BT 4		Z 80 WKCV 18-05-04-0
11	M 2	1.3343 S6-5-2	BM2		Z 85 WDCV
11	M 7	1.3348 S2-9-2			Z 100 DCWV 09-04-02-

 SS	 UNI	 UNE	 JIS	 KS	 GOST
1922		F.210.F	SUM 32	SUM 32	
2314	X 37 CrMoV 5 1 KU				
2242	X40CrMoV511KU	F-5318	SKD61	STD61	
2260	X100CrMoV51KU	F-5227	SKD12	STD12	
2310	X165CrMoW12KU	X160CrMoW12KU			
2736					
2312	X215CrW 12 1 KU	F-5213			
	X30WCv 9 3 KU	F-526	SKD5	STD5	
2310					
	X 35 CrMoW 05 KU	F.537			
2715	X210Cr13KU	X210Cr12	SUH3	STR3	
2584					
	14 Ni 6 KG;KT	XBNiO9			
	X10Ni9	F-2645	SL9N60(53)	SL9N590(520)	
	HS 12-1-5-5	12-1-5-5			
2723	HS 6-5-2-5	6-5-2-5	SKH55	SKH55	
7-4-2-5	HS 7-4-2-5	M 35			
2-10-1-8	HS 2-9-1-8 2-9-2-8	M 41			
2722	HS 652	F-5604	SKH 51	SKH 51	
2782	HS 292	F-5607			

Material Conversion Table





► According to VDI 3323 standard







Material group					
	AISI/SAE	Material No. DIN	BS	EN	AFNOR
11	T 1	1.3355 S 18-0-1	BT 1		Z 80 WCV 18-4-01
11	630	1.4548			Z7CNU17-04
11	HNV 3	1.4718 X45CrSi 9 3	401S45	52	Z45CS9
11	422	1.4935 x20 CrMoWV 12 1			
12	403	1.4000 X6Cr13	403 S 17		Z 6 C 13
12		1.4001 X6Cr14			
12	(410S)	1.4001 X7 Cr 13	(403 S 7)		Z 8 C 13
12	405	1.4002 X6CrA12	405S17		Z8CA12
12	405	1.4002 X6 CrAl 13	405 S 17		Z6CA13
12	416	1.4005 X12CrS 13	416 S 21		Z11 CF 13
12	410; CA-15	1.4006 (G-)X10 Cr 13	410S21	56A	Z10 C 13
12	430	1.4016 X8Cr17	Z8C17		430S15
12	430	1.4016 X6 Cr 17	430 S 15	60	Z 8 C 17
12		1.4027 G-X20Cr14	420 C 29		Z20 C 13M
12		1.4027 G-X 20 Cr 14	420 C 29		Z 20 C 13M
12	420	1.4028 X30 Cr 13	420 S 45		Z 30 C 13
12		1.4086 G-X120Cr29	452C11		
12	430 F	1.4104 X12CrMoS17	420 S 37		Z 10 CF 17
12	440B	1.4112 X90 CrMoV 18			
12	434	1.4113 X6CrMo 17	434 S 17		Z 8 CD 17.01
12		1.4340 G-X40CrNi27 4			
12	S31500	1.4417 X2CrNiMoSi19 5			
12	S31500	1.4417 X2 CrNoMoSi 18 5 3			
12		1.4418 X4 CrNiMo16 5			Z6CND16-04-01
12	XM 8	1.4510			Z 4 CT 17
	430 Ti				
	439				
12	430tl	1.4510 X6 CrTi 17			Z 4 CT 17
12		1.4511 X 6 CrNb 17(X 6 CrNb 17			Z 4 CNb 17
12	409	1.4512 X 6 CrTi 12 (X2CrTi12)	LW 19 409 S 19		Z 3 CT 12
12		1.4720 X20CrMo13			

					
SS	UNI	UNE	JIS	KS	GOST
	X45CrSi8	F322	SUH1	STR1	
2301	X6Cr13	F.3110 F8401	SUS403	STS 403	
2301	X6CrAl13				
2302	X6CrAl13				
2380	X12 CrSC13	F-3411	SUS 416	SUS 416	
2302	X12Cr13	F.3401	SUS 410	SUS 410	
2320	X8Cr17	F.3113			
2320	X8Cr17	F.3113	SUS 430	SUS 430	
2304					
2383	X10CrS17	F.3117	SUS430F	STS 430F	
2325	X8CrMo17		SUS434	STS 434	
2376					
2376					
2387	X 6 CrTi 17	F.3115-X 5 CrTi 17	SUS 430 LK	STS 430 LX	08 Ch17T
	X 6 CrNb 17	F.3122-X 5 CrNb 17	SUS 430 LK	STS 430 LX	
	X 6 CrTi 17		SUH 409	STR 409	

Material Conversion Table





► According to VDI 3323 standard







Material group					
	AISI/SAE	Material No. DIN	BS	EN	AFNOR
12	405	1.4724 X10CrA113	403S17		Z10C13
12	430	1.4742 X10CrA118	439S15	60	Z10CAS18
12	HNV6	1.4747 X80CrNiSi20	443S65	59	Z80CSN20.02
12	446	1.4749 x18 cRn 28			
12	446	1.4762 X10CrA124			Z10CAS24
12	EV 8	1.4871 X 53 CrMnNiN 21 9	349 S 54		Z 52 CMN 21.09
12	302	x12 CrNi 18 9	302 S 31		Z 10 CN 18-09
12	429	X10 CrNi 15			
13	420	1.4021 X20Cr13	420S37		Z 20 C 13
13	420	1.4031 X40 Cr 13			Z 40 C 14
13		1.4034 X46Cr13	420 S 45		Z40 C 14
13	431	1.4057 X20CrNi172	431 S 29	57	Z 15 CN 16.02
13		1.4125 X 105 CrMo 17			Z 100 CD 17
13	CA6-NM	1.4313 G-X4 CrNi 13 4	425 C 11		Z 4 CND 13-04 M
13	630	1.4542 X 5 CrNiCuNb 17 4 (X5CrNiCuNb 16-4)			
13		1.4544	S. 524 S. 526		
13	348	1.4546 X5CrNiNb 18-10	347 S 31 2 S. 130 2 S. 143/144/145 S.525/527		
13		1.4922 x20cRmV12-1			
13		1.4923 X22 CrMoV12 1			
14	304	1.4301 X 5 CrNi 18 9	304 S 15		Z 5 CN 18.09
14	303	1.4305 X10 CrNiS 18 9	303 S 21	58M	Z 8 CNF 18-09
14	304L	1.4306 X2CrNi18 9	304S12		Z2CrNi18 10
14	304L	1.4306 X2 CrNi 18 10	304 S 11		Z 3 CN 19-11
14	CF-8	1.4308 X6 CrNi 18 9	304 C 15	58E	Z 6 CN 18-10 M
14	301	1.4310 X12CrN i17 7	301 S 21		Z 12 CN 17.07

 SS	 UNI	 UNE	 JIS	 KS	 GOST
	X10CrA112	F.311			
	X8Cr17	F.3113	SUS430	STS430	
	X80CrSiNi20	F.320B	SUH4	STR4	
2322	X16Cr26		SUH446	STR446	
	X53CrMnNiN21 9		SUH35,SUH36	STR35,STR36	
2330					
2303	14210				
-2304					
	X40Cr14	F.3405	SUS420J2	STS420J2	
2321	X16CrNi16	F.3427	SUS431	STS431	
	X 105 CrMo 17				
2385	(G)X6CrNi304		SCS5	SSC5	
	X 6 CrNiTi 18 11				08Ch 18N12T
	X 6 CrNiNb 18 11				
2317	x20cRmOnl 12 01				
2332;2333					
2346	X10CrNiS18.09	F.3508	SUS303	STS303	
2352	x2cRnI18 11	F.3503	SCS19	SSC19	
2352	X2CrNi18 11				
2333			SUS304L	STS304L	
2331	X2CrNi18 07	F.3517			

Material Conversion Table





► According to VDI 3323 standard







Material group					
	AISI/SAE	Material No. DIN	BS	EN	AFNOR
14	304 LN	1.4311 X2 CrNiN 18 10	304 S 62		Z 2 CN18.10
14		1.4312 G-X10CrNi18 8	302C25		Z10CN18.9M
14	305	1.4312 X8 CrNi 18 12	305 S 19		
14		1.4332 X2 CrNi 18-8			
14	304	1.4350 X5CrNi18 9	304S15	58E	Z6CN18.09
14	S32304	1.4362 X2 CrNiN 23 4			Z 2 CN 23-04 AZ
14	202	1.4371 X3 CrMnNiN 188 8 7	284 S 16		Z 8 CMN 18- 08-05
14	316	1.4401 X 5 CrNiMo 17 12 2 (X4 CrNiMo 17 -12-2)	316 S 13 316 S 17 316 S 19 316 S 31 316 S 33		Z 3 CND 17 -11-01 Z 6 CND 17-11 Z 6 CND 17-11-02 Z 7 CND 17-11-02 Z 7 CND 17-12-02
14	316L	1.4404 X2 CrNiMo 17 13 2 (X2 CrNiMo 17-12-2) GX 2 CrNiMoN 18-10	316 S 11, 316 S 13 316 S 14, 316 S 31; 316 S 42, S.537,316 C 12, T.75, S. 161		Z 2 CND 17-12 Z 2 CND 18-13 Z 3 CND 17-11-02 Z 3 CND 17-12-02 FF Z 3 CND 18-12-03 Z 3 CND 19.10 M
14	316LN	1.4406 X2 CrNiMoN 17 12 2 (X2CrNiMoN 18-10)	316 S 61 316 S 63		Z2 CND 17-12 AZ
14	CF-8M	1.4408 GX 5 CrNiMoN 7 12 2 G-X 6 CrNiMo 18 10	316 C 16 (LT 196) ANC 4 B		
14		1.4410 G-X10CrNiMo18 9			Z5CNaD20.12M
14	316 Ln	1.4429 X2 CrNiMo 17 -13-3	316 S 62		Z 2 CND 17-13 Az
14	316L	1.4435 X2 CrNiMo18 14 3	316 S 11;316 S 13 316 S 14;316 S 31 LW 22 LWCF 22		Z 3 CND 17-12-03 Z 3 CND 18-14-03
14	316	1.4436 X 5 CrNiMo 17 13 3 (X4CRNIMO 17-13-3)	316 S 19; 316 S 31 316 S 33 LW 23 LWCF 23		Z 6 CND 18-12-03 Z 7 CND 18-12-03

					
SS	UNI	UNE	JIS	KS	GOST
2371	X2CrNi18 10		SUS304LN	STS304LN	
2332	X5CrNi18 10	F.3551	SUS304	STS304	
2347	X 5 CrNiMo 17 12	F.3534-X 5 CrNiMo 17 12 2	SUS 316	STS 316	
2348	X 2 CrNiMo 17 12	F.3533 - X 2 CrNiMo 17 13 2			
	G-X 2 CrNiMo 19 11	F.3537 - X 2 CrNiMo 17 13 3	SUS 316 L	STS 316 L	
	X 2 CrNiMoN 17 12	F.3542-X 2 CrNiMoN 17 12 2	SUS316LN	STS316LN	
2343		F.8414-AM-X 7 CrNiMo 20 10	SCS 14	SSC 14	07 Ch 18N10G2S2MSL
2328					
2375	X 2 CrNiMoN 17 13	F.3543-X 2 CrNiMoN 17 13 3	SUS 316 LN	STS 316 LN	
2375	X 2 CrNiMoN 17 13	F.3533-X 2 CrNiMo 17 13 2	SUS 316 L	STS 316 L	O3 Ch 17N14M3
2343	X 5 CrNiMo 117 13 X 8 cRnImO 17 13	F.3543-X 5 CrNiMo 17 12 2 F.3538-X 5 CrNiMo 17 13	SUS 316	STS 316	

Material Conversion Table





► According to VDI 3323 standard







Material group					
	AISI/SAE	Material No. DIN	BS	EN	AFNOR
14	317L	1.4438 X2 CrNiMo 18 16 4 (X2CrNiMo 18-15-4)	317 S 12		Z 2 CND 19-15-04 z 3 cnd 19-15-04
14	(s31726)	1.4439 X2 CrNiMoN 17 13 5			Z 3 CND 18-14-06 AZ
14		1.4440 X 2 CrNiMo 18 13			
14	317	1.4449 X5 CrNiMo 17 13 3	317 S 16		
14	329	1.4449 X 4 CrNiMo 27 5 2 1.4460 (X3CrNiMo27-5-2)			(Z 3 CND 25-07 Az) Z 5 CND 27-05 Az
14	329	1.4460 X8CrNiMo27 5			
14		1.4462 X2CrNiMoN22 5 3	318 S 13		Z 3 CND 22-05 Az (Z 2 CND 24 -08 Az) (Z 3 CND 25-06-03 Az)
14		1.4500 G-X7NiCrMoCuNb25 20			Z3NCDU25.20M
14	17-7PH	1.4504	316S111		
14	443 444	1.4521 X2CrMoTi18-2	317 S 16		
14	UNS N 08904	1.4539 X1NiCrMoCuN25-20-5			Z 2 NCDU 25-20
14	CN-7M	1.4539 (G-)X1 NiCrMoCu 25 20 5			Z1 NCDU 25-02 M
14	321	1.4541 Z 6 CrNiTi 18-10	321 S 31 321 S 51 (1010;1105) LW 24 LWCF 24		Z 6 CNT 18-10
14	630	1.4542 X5 CrNiCuNb 17 4 (X5 CrNiChNb 16-4)			Z 7 CNU 15-05 Z 7 CNU 17-04
14	17-4PH	1.4542			Z7CNU17-04
14	S31254	1.4547 X1 CrNiMoN 20 18 7			
14	17-4PH	1.4548			Z7CNU17-04
14	347	1.4550 X6 CrNiNb 18 10	347 S 17	58F	Z 6 CNNb 18.10
14		1.4552 G-X7CrNiNb18 9			Z4CNNb19.10M
14	17-7PH	1.4568	316S111		
14	316Ti	1.4571 X6 CrNiMoTi 17 12 2	320 S 31		Z 6 CNDT 17-12002
14		1.4581 G-X 5 CrNiMoNb	318 C 17		Z 4 CNDNb 18.12 M
14	318	1.4583 X 10CrNiMoNb 18 12	303 S 21		Z15CNS20.12

 SS	 UNI	 UNE	 JIS	 KS	 GOST
2367	X2CrNiMo18 16	f.3539-x 2 cRnlmO 18 16 4	SUS317L	STS317L	
	X 5 CrNiMo 18 15		SUS 317	STS 317	
2324		F.3309-X 8 CrNiMo 17 12 2 F.3552-X 8 CrNiMo 18 16 4	SUS 329 J 1	STS 329 J 1	
2377			SUS 329 J3L	STS 329 J3L	
	Z8CNA17-07	X2CrNiMo1712			
2326		F.3123-X 2 CrMoTiNb 18 2	SUS 444	STS 444	
2562					
2564					
2337	X 6 CrNiTi 18 11	F.3523 - X 6 CrNiTi 18 10	SUS 321	STS 321	06Ch18N10T 08Ch18N10T 09Ch18N10T 12Ch18N10T
			SCS 24 SUS 630	SSC 24 STS 630	
2378					
2338	X6CrNiNb18 11	F.3552	SUS347	STS347	
	Z8CNA17-07	X2CrNiMo1712			
2350					
	x15cRnIsl2 12				

Material Conversion Table





► According to VDI 3323 standard







Material group					
	AISI/SAE	Material No. DIN	BS	EN	AFNOR
14		1.4585 G-X7CrNiMoCuNb18 18			
14		1.4821 X20CrNiSi25 4			Z20CNS25.04
14		1.4823 G-X40CrNiSi27 4			
14	309	1.4828 X15CrNiSi20 12	309 S 24	58C	Z15CNS20.12
14	309S	1.4833 X6 CrNi 22 13	309 S 13		Z 15 CN 24-13
14	310 S	1.4845 X12 CrNi 25 21	310S24		Z 12 CN 25-20
14	321	1.4878 X6 CrNiTi 18 9	32 1 S 20	58B	Z 6 CNT 18-12 (B)
14	Ss30415	1.4891 X5 CrNiNb 18 10			Z20CNS25.04
14	S30815	1.4893 X8 CrNiNb 11			
14	304H	1.4948 X6 CrNi 18 11	304 S 51		Z 5 CN 18-09
14	660	1.498 X5 NiCrTi 25 15			Zz 8 nctv 25-15 b ff
14		X5 NiCrN 35 25			
14	S31753	X2 CrNiMoN 18 13 4			
14		X2 CrNiMoN 25 22 7			
15	CLASS20	0.6010 GG10			Ft10D
15	A48-20B	0.6010 GG-10			Ft 10 D
15	NO 25 B	0.6015 GG 15	Grade 150		Ft 15 D
15	CLASS25	0.6015 GG 15	Grade 150		Ft 15D
15	A48 25 B	0.6015 GG 15	Grade 150		Ft 15 D
15	A48-30B	0.6020 GG-20	Grade 220		Ft 20 D
15	NO 30 B	0.6020 GG 20	Grade 220		Ft 20 D
15	A436 Type 2	0.6660 GGL-NiCr202	L-NiCuCr202		L-NC 202
15	60-40-18	0.7040 GGG 40	SNG 420/12		FCS 400-12
15	No 20 B	GG 10			Ft 10 D
16	CLASS30	0.6020 GG 20	Grade 220		Ft 20D
16	CLASS45	0.6030 GG 30	Grade 300		Ft 30D
16	A48-45 B	0.6030	Grade 350		Ft 30D
16	A48-50	0.6035 GG-35	Grade 350		Ft 35 D
16	A48-60 B	0.6040 GG40	Grade 400		Ft 40 D
16	100/70/03	0.7070 GGG-70	SNG700/2		FGS 700-2

					
SS	UNI	UNE	JIS	KS	GOST
	X6CrNiMoTi17 12				
		F.8414	SCS17	SSC17	
2361	X6CrNi25 20	F.331	SUH310	STR310	
2337	X6CrNiTi18 11	F.3553	SUS321	STS321	
2372					
2368					
2333					
2570					
110	G 10				
0110-00					
0115-00	G 15	FG 15	FC150	GC150	
115	G 15	FG 15			
01 15-00	G 14	FG 15			
0120-00					
120	G 20		FC200	GC200	
0523-00					
0717-02	GS 370-17	FGE 38-17	FCD400	GCD400-18,15	
110			FC100	GC100	
120	G 20	FG 20			
130	G 30	FG 30	FC300	GC300	
01 30-00					
135	G 35	FG 35	FC350	GC350	
140					
07 37-01	GGG 70	GGG 70	FCD700	GCD700-2	

Material Conversion Table

► According to VDI 3323 standard





Material group					
	AISI/SAE	Material No. DIN	BS	EN	AFNOR
16		1.4829 X 12 CrNi 22 12			
17		0.7033 GGG35.3			
17		0.7033 GGG-35.3	350/22 L 40		FGS 370/17
17	60-40-18	0.7040 GGG-40	SNG 420/12		FGS 400-12
17	60/40/18	0.7043 GGG-40.3	370/7		FGS 370/17
17	80-55-06	0.7050 GGG50	SNG500/7		FGS 500/7
17	65-45-12	0.7050 GGG-50	SNG 500/7		FGS 500-7
17		0.7652 GGG-NiMn 13 7	S-NiMn 137		S-Mn 137
17	A43D2	0.7660 GGG-NiCr 20 2	Grade S6		S-NC 202
17		GGG 40.3	SNG 370/17		FGS 370-17
18	A48-40 B	0.6025 GG25	Grade260		Ft 25 D
18		0.7060 GGG60	SNG600/3		FGS600-3
18	80/55/06	0.7060 GGG-60	600/3		FGS 600/3
18	A48 40 B				
19		0.8055 GTW55			
19	32510	0.8135 GTS-35-10	B 340/12		MN35-10
19	A47-32510	0.8135 GTS-35-10	B 340/2		Mn 35-10
19	A220-40010	0.8145 GTS-45-06	P 440/7		Mn 450-6
19		GTS-35	B 340/12		
19			8 290/6		MN 32-8
19	32510	GTS-35	B340/12		MN 35-10
20		0.8035 GTM-35	W340/3		MB35-7
20		0.8040 GTW-40	W410/4		MB40-10
20		0.8045			
20		0.8065 GTMW-65			
20	A220-50005	0.8155 GTS-55-04	P 510/4		Mn 550-4
20	50005	0.8155 GTS-55-04	P 510/4		MP 50-5
20	70003	0.8165 GTS-65-02	P 570/3		Mn 650-3
20	90001	0.8170 GTS-70-02	P 690/2		Mn 700-2
20	A220-90001	0.8170 GTS-70-02			Mn 700-2

					
SS	UNI	UNE	JIS	KS	GOST
0717-15					
0717-15					
0717-02					
0717-15					
0727-02	GGG 50				
	0727-02		FCD 500	GCD 500-7	
0772-00					
0776-00					
0717-12					
125	G 25	FG 25	FC250	GC250	
07 32-03	GGG 60	GGG 60			
0727-03			FCD600	GCD600-3	
		GTW 55			
810		GTS 35			
0815-00					
	0852-00	GMN 45			FCMW370
0810-00					
814			AC4A	AC4A	
08 15			FCMW330	FCMW330	
852		GTM 35			
	GTB40	GTM 40			
	GMB45	GTM 45			
		GTM 65			
0854-00					
0854-00	GMN 55		FCMP490	PMC 490	
0856-00	GMN 65		FCMP590	PMC 590	

Material Conversion Table





► According to VDI 3323 standard

Material group					
	AISI/SAE	Material No. DIN	BS	EN	AFNOR
20		0.8170 GTS-70-02	IP 70-2		
20	1022				
	1518	1.1133 20Mn5	120 M 19		20 M 5
20	1035	1.1183 Cf 35 (C35G)	080 A 35		XC 38 H 1 TS
20	400 10	GTS-45	P440/7		
20	70003	GTS-65	P 570/3		MP 60-3
21	Al99	3.0205			
21	1000	3.0255 Al99.5	L31/34/36		A59050C
21		3.3315 AlMg1			
22		3.1325 AlCuMg 1			
22		3.1655 AlCuSiPb			
22		3.2315 AlMgSi1			
21	7050	3.4345 AlZnMgCuO,5	L 86		AZ 4 GU/9051
23		3.2381 G-AlSi 10 Mg			
23		3.2382 GD-AlSi10Mg			
23		3.2581 G-AlSi12			
23		3.3561 G-ALMg 5			
23	ZE 41	3.5101 G-MgZn4sE1Zr1	MAG 5		
23	EZ 33	3.5103 MgSE3Zn27r1	MAG 6		G-TR3Z2
23	AZ 81	3.5812 G-MgAl8Zn1	NMAG 1		
23	AZ 91	3.5912 G-MgAl9Zn1	MAG 7		
24		2.1871 G-AlCu 4 TiMg			
24		3.1754 G-AlCu5Ni1,5			
24		3.2163 G-AlSi9Cu3			
24	4218 B	3.2371 G-AlSi 7 Mg			
24	SC64D	3.2373 G-AlSi9MGWA			A-S7G
24		3.2373 G-AlSi 9 Mg			
24	QE 22	3.5106 G-MgAg3SE2Zr1	mag 12		
24	GD-AISI12	G-ALMG5	LM5		A-SU12
23-24	A360.2	3.2383 G-AlSi0Mg(Cu)	LM9		

 SS	 UNI	 UNE	 JIS	 KS	 GOST
0862-00	GMN 70		FCMP690	PMC 690	
0864-00					
2132	G 22 Mn 3				
	20 Mn 7	F.1515-20 Mn 6	SMnC 420	SMnC 420	
1572	C 36; C 38		S 35 C	SM 35 C	35
08 52					
858			FCMP540	PMC 540	
811-04					
4231			C4BS	C4BS	
4252					
4253					





Material Conversion Table

► According to VDI 3323 standard

Material group				
	AISI/SAE	Material No. DIN	BS	EN
				AFNOR
23-24	A356-72		2789;1973	NF A32-201
23-24	356.1		LM25	
23-24	A413.2	G-ALSi12	LM6	
23-24	A413.1	G-ALSi 12 (Cu)	LM20	
23-24	A413.0	GD-ALSi12		
23-24	A380.1	GD-ALSi8Cu3	LM24	
26	C93200	2.1090 G-CuSn 7 5 pb		U-E 7 Z 5 pb 4
26	C83600	2.1096 G-CuSn5ZnPb	LG 2	
26	C83600	2.1098 G-CuSn 2 Znpb		
26	C23000	2.1182 G-CuPb15Sn	LB1	U-pb 15 E 8
26	C93800	2.1182 G-CuPb15Sn		Uu-PB 15e 8
27		2.0240 CuZn 15		
27	C27200	2.0321 CuZn 37	cz 108	CuZn 36, CuZn 37
27	C27700	2.0321 CuZn 37	cz 108	CuZn 36, CuZn 37
27		2.0590 G-CuZn40Fe		
27	C 86500	2.0592 G-CuZn 35 Al 1	U-Z 36 N 3	HTB 1
27	C 86200	2.0596 G-CuZn 34 Al 2	HTB 1	U-Z 36 N 3
27	C 18200	2.1293 CuCrZr	CC 102	U-Cr 0.8 Zr
28		2.0060 E-Cu57		
28		2.0375 CuZn36Pb3		
28	C 94100	2.0596 G-CuZn 34 Al 2	HTB 1	U-Z 36 N 3
28	C 63000	2.0966 CuAl 10 Ni 5 Fe 4	Ca 104	U-A 10 N
28	B-148-52	2.0975 G-CuAl 10 Ni		
28	C 90700	2.105 G-CuSn 10	CT1	
28	C 90800	2.1052 G-CuSn 12	pb 2	UE 12 P
28	C 81500	2.1292 G-CuCrF 35	CC1-FF	
28		2.4764 CoCr20W15Ni		
31	N 08800	1.4558 X 2 NiCrAlTi 32 20	NA 15	
31	N 08031	1.4562 X 1 NiCrMoCu 32 28 7		



Material Conversion Table







► According to VDI 3323 standard

Material group					
	AISI/SAE	Material No. DIN	BS	EN	AFNOR
31	N 08028	1.4563 X 1 NiCrMoCuN 32 27 4			
31	N 08330	1.4564 X 12 NiCrSi 36 16	NA 17		Z 12 NCS 35.16
31	330	1.4564 X12 NiCrSi 36 16	NA 17		Z 12 NCS 37.18
31		1.4865 G-X40NiCrSi38 18	330 C 40		
31		1.4958 X 5 NiCrAlTi 31 20			
31	AMS 5544	LW2.4668 NiCr19NbMo			NC20K14
32		1.4977 X 40 CoCrNi 20 20			Z 42 CNKDOWNb
33	Monel 400	2.4360 NiCu30Fe	NA 13		NU 30
33	5390A	2.4603			NC22FeD
33	Hastelloy C-4	2.4610 NiMo16Cr16Ti			
33	Nimonic 75	2.4630 NiCr20Ti	HR 5,203-4		NC 20 T
33		2.4630 NiCr20Ti	HR5,203-4		NC20T
33	Inconel 690	2.4642 NiCr29Fe			Nnc 30 Fe
33	Inconel 625	2.4856 NiCr22Mo9Nb	NA 21		NC 22 FeDNb
33	5666	2.4856 NiCr22Mo9Nb			Inconel 625
33	Incoloy 825	2.4858 NiCr21Mo	NA 16		NC 21 Fe DU
34	Monel k-500	2.4375 NiCu30 Al	NA 18		NU 30 AT
34	4676	2.4375 NiCu30Al	3072-76		
34		2.4631 NiCr20TiAl	Hr40;601		NC20TA
34	Inconel 718	2.4668 NiCr19FeNbMo			NC 19 Fe Nb
34	Inconel	2.4694 NiCr16fE7TiAl			
34		2.4955 NiFe25Cr20NbTi			
34	5383	LM2.4668 NiCr19Fe19NbMo	HR8		NC19eNB
34	5391	LW2 4670 S-NiCr13A16MoNb	3146-3		NC12AD
34	5660	LW2.4662 NiFe35Cr14MoTi			ZSNCDT42
34	5537C	LW2.4964 CoCr20W15Ni			KC20WN
34	AMS 5772	C0Cr22W14Ni			KC22WN
35	Inconel X-750	2.4669 NiCr15Fe7TiAl			NC 15 TNb A
35	Hastelloy B	2.4685 G-NiMo28			
35	Hastelloy C	2.4810 G-NiMo30			

Material Conversion Table

► According to VDI 3323 standard

Material group				
	AISI/SAE	Material No. DIN	BS	EN AFNOR
35	AMS 5399	2.4973 NiCr19Co11MoTi		NC19KDT
35		3.7115 TiAl5Sn2		
36	R 50250	3.7025 Ti 1	2 TA 1	
36	R 52250	3.7225 Ti 1 pd	TP 1	
36	AMS 5397	LW2 4674 NiCo15Cr10MoAlTi		
37		3.7124 TiCu2	2 TA 21-24	
37	R 54620	3.7145 TiAl6Sn2Zr4Mo2Si		
37		3.7165 TiAl6V4	TA 10-13;TA 28	T-A 6 V
37		3.7185 TiAl4Mo4Sn2	TA 45-51; TA 57	
37		3.7195 TiAl 3 V 2.5		
37		TiAl4Mo4Sn4Si0.5		
37	AMS R54520	TiAl5Sn2.5	TA14/17	T-A5E
37	AMS R56400	TiAl6V4	TA10-13/TA28	T-A6V
37	AMS R56401	TiAl6V4ELI	TA11	
38	W 1	1.1545 C105W1	BW 1A	Y1105
38	W210	1.1545 C105W1	BW2	Y120
38		1.2762 75 CrMoNiW 6 7		
38	440C	1.4125 X105 CrMo 17		Z 100 CD 17
38		1.6746 32 nlcRmO 14 5	832 M 31	35 NCD 14
40	Ni- Hard 2	0.9620 G-X 260 NiCr 4 2	Grade 2 A	
40	Ni- Hard 1	0.9625 G-X 330 Ni Cr 4 2	Grade 2 B	
40	Ni- Hard 4	0.9630 G-X 300 CrNiSi 9 5 2		
40		0.9640 G-X 300 CrMoNi 15 2 1		
40	A 532 III A 25% Cr	0.9650 G-X 260 Cr 27	Grade 3 D	
40	A 532 III A 25% Cr	0.9655 G-X 300 CrNMo 27 1	Grade 3 E	
40		1.2419 105 WCr 6	105WC 13	
40	310	1.4841 X15 CrNiSi 25 20	314 S31	Z 15 CNS 25-20
41		0.9635 G-X 300 CrMo 15 3		
41		0.9645 G-X 260 CrMoNi 20 2 1		
41		0.9655 G-X 300 CrNMo 27 1		

 SS	 UNI	 UNE	 JIS	 KS	 GOST
1880	C100KU	F-5118	SK3	STC 105(STC3)	
2900	C120KU	CF.515	SUP4	SPS 4	
	0512-00				
	0513-00				
	0466-00				
		107 WCr 5 KU			

ADVANCE CUTTING

TaeguTec



- Cat. no.: 6244066
- English version: CT 02/2023
- ©TaeguTec LTD.